

Instruction Manual

Curve Tracer CS-5000 series

CS-5100

CS-5200

CS-5300

CS-5400



IWATSU

Preface

- ◇ Thank you for purchasing the Curve Tracer CS-5000 series. Please use Iwatsu instruments regularly for a long time in future.
- ◇ Please read this manual carefully and understand its contents before using this Curve tracer, and then keep this manual handy for future reference.
- ◇ This instruction manual describes the precaution, installation and operation of the following Curve Tracer CS-5000 series: CS-5100, CS-5200, CS-5300 and CS-5400.
- ◇ The following manual, including this one, is provided as manual for the Curve Tracer 5000 Series.

The CS-3000_5000 Series Remote Control Manual explains the remote control for the Curve Tracer used the usual LAN interface through 10Base-T/100Base-TX and adopts VXI-11 as the communication protocol. Please read the manual, too.

Notices

- ◇ This manual corresponds to the software version 1.37 of Curve Tracer.
- ◇ Parts of the contents of this manual may be modified without notice for improvements in performance and functions.
- ◇ Reproduction or reprinting of the contents of this manual without prior permission from Iwatsu is prohibited.
- ◇ For questions about this instrument, contact IWATSU listed at the end of this manual or our sales distributors.



Manual Part Number

- ◇ KML112431



Revision history

- ◇ January 2013: 1st edition
- ◇ September 2016: 8th edition
- ◇ May 20017: 9th edition
- ◇ October 20017: 10th edition
- ◇ July 2018: 11th edition
- ◇ July 2020: 12th edition



Important Safety Precautions

To ensure safe operation of this instrument and to prevent injury to the user or damage to property, items to be observed are written in the  WARNING and  CAUTION in this manual. Be sure to read them for safe operation. In addition, marks indicating attention are attached on the panel.

Definitions of WARNING and CAUTION used in this manual

 WARNING	Incorrect operation or failure to observe the warning may result in death or serious injury.
 CAUTION	Incorrect operation or failure to observe the caution may result in injury or damage to the instrument.

Explanation of symbols on panel

 ELECTRIC SHOCK	Incorrect operation may cause electric shock. This symbol calls attention. To protect the user, read items in this manual before using this instrument.
 WARNING	To prevent injury to the user or damage to this instrument, read items in this manual before using this instrument.

 **WARNING**

- **In measurement with this instrument, high voltage may be applied and high current may be supplied. Always close the cover before measurement after setting the DUT (Device under test) on the test fixture.**

High voltage (max. 5kV) may be applied and high current (max. 1.5kA) may be supplied to the terminal to which the DUT is mounted. To prevent danger, if the cover of the test fixture is not closed, no voltage and current can be supplied to the terminal and no power can be applied to the DUT. And, do not remodel the switch for power supply shutoff or do not open the cover during measurement. If not, electric shock may be caused.

- **Do not open the cover of the test fixture during measurement.**

High voltage (max. 5kV) and high current (max. 1.5kA) may be applied to the terminal to which the DUT is mounted. To prevent danger or to protect the DUT, when detecting that the cover of the test fixture opens, the instrument immediately shuts off the voltage and current applied to the terminal and stops the power supply to the DUT. And for safety, do not open the cover of the test fixture during measurement.

- **After measurement, the DUT may be charged. Do not touch the DUT until discharging it through the grounding rod and confirming the safety.**

Touching the charged DUT may cause electric shock.

- **Do not use other than attached Test Lead sets (alligator-banana clip)**

(Only for CS-5200/CS-5300/CS-5400)

If measurement is done without considering measurement electric potential and usage rating of the cable outer cover and GND cable outer cover, fire or failures may be caused. Use the specified cables attached depending on measurement types.

Read this page to ensure proper safety. (Also read the following pages.)

 **WARNING** (Continued)

- **If you notice smoke, abnormal smell or abnormal sound, immediately take measures below and remove the power plug from the receptacle.**

- (1) Make the power switch a standby.
- (2) Remove the power plug from the receptacle.

Continued use under these circumstances may result in electric shock or fire. After taking measures above, contact Iwatsu office or our sales distributors for repair. Repairing the instrument yourself is very dangerous. Do not attempt to repair the instrument under any circumstances.

- **Do not use in an environment with explosive gases.**

This may result in explosion.

- **Make sure no water gets on or inside the instrument.**

Failure to observe this precaution may result in electric shock or fire. If water gets on or inside the unit, after making the power switch a standby, and pulling out the power plug from the power outlet, contact Iwatsu office or our sales distributors for repair.

- **Do not touch the plug of the power cord if your hands are wet.**

This may result in electric shock.

- **Do not place this instrument on an unstable place such as a shaky stand or inclined place.**

Letting this instrument fall or topple down may result in electric shock, fire or injury. If this instrument falls or its cover is damaged, after making the power switch a standby, and pulling out the power plug from the power outlet, contact Iwatsu office or our sales distributors for repair.

- **Surely insert the power plug into the power receptacle after checking that any dust is not sticking to the power plug. Additionally, disconnect the power plug or power adaptor from the receptacle once every six months to one year, and inspect and/or clean the power plug.**

If the power plug is contaminated, this may cause an electric shock, a fire, or a malfunction.

Read this page to ensure proper safety. (Also read the following pages.)

WARNING (Continued)

- **Do not put any foreign objects, such as metallic or flammable objects through the ventilation opening.**

If any foreign object of metal and the combustible one, etc. is put through the ventilation opening, this may result in electric shock, fire, and/or malfunction.

If any foreign object enters this instrument, after making the power switch a standby, and pulling out the power plug from the power outlet, contact Iwatsu office or our sales distributors for repair.

- **Always use a 3-prong power cord that suits power supply voltage for this instrument.**

Using a power cord that is incompatible with the power voltage may result in electric shock, fire and/or malfunction. Additionally, using a 2-prong power cord may result in electric shock.

Unless otherwise specified at purchase, a 100V (90 V to 132 V) power cord is supplied with the instrument. If operating the instrument at 200V (180 V to 250 V), always use the 3-prong power cord (optional) for 200V systems (rating: 250V) specified by Iwatsu.

- If the power is supplied from the 2 prong receptacle using the 3-prong/2-prong conversion adapter, ground the GND terminal of the adapter.
- When using the attached 3-prong power cord to supply the power from the 3- prong receptacle, grounding is made through the GND line of the power cord.

- **Use this instrument at a specified supply voltage.**

Using this instrument at a voltage other than specified may result in electric shock, fire or malfunction. Usable power supply voltage range is written on the rear panel.

- **Do not remove the case, cover and panel.**

Since there are parts with a high voltage in this instrument, touching the part may cause electric shock. When performing inspection, calibration, or repair, contact Iwatsu office or our sales distributors.

- **When handling power cord, observe items below:**

If not, fire or electric shock may occur. If the power cord is damaged, contact Iwatsu office or our sales distributors for repair.

- Do not attempt to fabricate the power cord.
- Do not pull the power cord.
- Do not forcibly bend the power cord.
- Do not heat the power cord.
- Do not twist the power cord.
- Avoid getting the power cord wet.
- Do not bind the power cord together.
- Do not place heavy objects on the top of the power cord.

- **Do not modify or repair this instrument.**

Modifications or repairs made by users may result in an electric shock, a fire, or a malfunction. This instrument cannot be repaired by users. Do not open it to attempt repairs. For repairs, contact Iwatsu office or our sales distributors. Note that modified products will not be accepted for repairs.

Read this page to ensure proper safety. (Also read the following pages.)

 **WARNING** (Continued)

- **If a lightning occurs near the instrument operation place, immediately make the power switch a standby and disconnect the power plug from the power receptacle.**

A lightning may cause an electric shock, a fire, or a malfunction.

- **Do not allow metal objects, etc., to touch the metal blades of the power plug.**

Contact with a metal object, etc., may cause a fire or electric shock.

- **Do not use multiple-connection receptacles.**

Power strips and other multiple-connection receptacles may cause a fire or overheating.

- **Do not place containers of water or chemicals, small metal objects, etc. near this instrument.**

If the contents are spilled and enter the instrument, it may cause a fire or an electric shock. If water, chemicals, or metal objects enter the instrument, set the power switch to standby, remove the plug from the receptacle, and then contact Iwatsu office or our sales distributors for repair.

- **Do not use this instrument if it is not functioning correctly.**

Using a malfunctioning instrument (due to dropping, etc.) may cause an electric shock or a fire. If the instrument is not functioning correctly, set the power switch to standby, remove the plug from the receptacle, and then contact Iwatsu office or our sales distributors for repair.

- **Do not place this instrument in an area where frequent vibrations or impacts occur.**

If this instrument is dropped or overturned, it may cause a physical injury.

- **If this instrument is dropped, it may result in a physical injury or property damage.**

Before transporting this instrument, remove all devices under testing, probes and cables and then carry it carefully by two people or more to avoid dropping.

- **Always use a 3-prong power cord applicable to the power voltage.**

When using a power cord not applicable to the power voltage, fire may occur.

In addition, use of 2-prong power cord may cause electric shock.

Unless specified when purchasing the instrument, the power cord for the 100V system (90V to 132V) is supplied with this instrument. If this instrument is operated with the power voltage changed to the 200V system (180 to 250V), always use the 3-prong power cord for the 200V system (rating: 250V) specified by our company (option).

- **When disconnecting the power cord from the receptacle, hold the plug to pull it out**

Pulling the power cord may damage it, resulting in electric shock or fire.

Read this page to ensure proper safety. (Also read the following pages.)

CAUTION

- **Set the power supply cord up in the place where it is pulled out easily.**
When this instrument is a dicey situation, it is necessary to cut power off promptly. Do not attempt to place this instrument in the location where difficult to remove the power supply cord from the receptacle.
- **Do not use the power cord attached to this instrument for other electric apparatuses.**
The power cord attached to this instrument cannot be used for other electric apparatuses in accordance with the electric apparatus safety laws.
- **Connect or disconnect the power cord after the POWER switch has been made a standby.**
If not, fire or overheating may be caused.
- **Do not short-circuit the blade of the power cord plug with metal and others.**
If touched with metal, fire or electric shock may be caused.
- **Do not use any damaged power cord, cable or adaptor.**
If any damaged power cord, cable or adaptor is used, this may result in electric shock and/or fire.
- **Do not place an object on this instrument.**
The cover comes in contact with an internal circuit when the object is put on this instrument, and then electric shock, fire, or failures may be caused.
- **Do not place an object near the ventilation opening and fan of this instrument.**
This may cause the inside to be filled with heat, resulting in fire or failures.
- **Ensure the spaces at the both sides and rear side of this instrument.**
Otherwise, this may cause operation or performance to be failed. Open the space of about 100mm to the left side, the right side, and the back of this instrument. When mounting it on the other instrument, attention should be directed to temperature increase.
- **When connecting wire to DUT(device under test), check indications of each terminal and carefully avoid incorrect wiring.**
Incorrect wiring may conduct wrong measurement. Also mis-connection may cause of damage on DUT and/or malfunction of the unit.
 - When wrongly connecting Collector terminal and Base terminal;
DUT may be damaged while extra high voltage can be supplied on Base terminal.
 - When NOT connecting Collector output terminal, Base output terminal and Emitter terminal and connecting Collector sense terminal, Base sense terminal and/or Emitter sense terminal respectively;
It may cause for burn of SENSE RESISTERS inside of the unit since the sense resistors connected to outputs respectively for Kelvin sensing and may be supplied current exceeding each specification.
 - When connecting HIGH VOLTAGE terminal and HIGH CURRENT terminal of collector output at the same time on DUT;
It may be cause for fire and/or malfunction due to high voltage applied to HIGH CURRENT terminal. When changing test conditions, change wiring properly and accordingly. Avoid to connect multiple outputs on the same terminal. This unit has 5(five) kinds of outputs as HIGH VOLTAGE output of Collector, HIGH CURRENT output of Collector, Base output, Emitter output and AUX output.

Read this page to ensure proper safety. (Also read the following pages.)

 **CAUTION** (Continued)

- **Do not place this instrument in the location with much moisture (bathroom, etc.) or dirt.**
If not, electric shock or fire may be caused.
- **Do not expose this instrument to the direct sunlight or with much moisture.**
Direct sunlight may the inner temperature to increase, resulting in fire.
- **Do not place this instrument in a location next to a worktable or humidifier, where it may be exposed to oily smoke or steam.**
Doing so may cause an electric shock or fire.
- **Before moving this instrument, remove the power cord and external connection cables from this instrument.**
If not, the cord or the cable may be damaged, resulting in fire or electric shock.
- **When connecting the power cord or measurement cable, care should be taken so that you do not pull such cable. If such cable is pulled, this may cause the instrument to be laid down.**
If this instrument is laid down, this may cause an electric shock, a personal injury, a fire, or a malfunction.
- **Use this instrument within the specified operation and storage range.**
Using outside a regulated system requirements or keeping it outside a regulated environment may cause malfunction.
If not, an failure may be caused. Usable temperature range is as follows:
 - Only indoor use
 - Operation temperature : 0 °C to +40 °C
 - Operation humidity : 5 %~80 %RH (at 30 °C or less) and no dew condensation allowed
Upper bound value 55 %RH (at 40 °C) and no dew condensation allowed
 - Storage temperature : -20 °C~+60 °C
 - Storage humidity : 5 %~80 %RH (no dew condensation allowed)
- **When transporting this instrument, detach the power cord, the cable, and the adaptor, etc. and use the packing material provided at the time of purchase or packing material equivalent at least.**
Excessive vibration or shock applied to this instrument during transportation may cause it to malfunction, resulting in fire. If you do not have the proper packing material or shock absorbing material, contact Iwatsu office or our sales distributors. When having the instrument transported by a shipping company, write "Precision Instrument - Handle With Care" on each side of the packing box.
- **Prior to maintenance, remove the power plug from the outlet for safety. Use a cloth to wipe away any moisture.**
Cleaning this instrument while the power plug is connected to the outlet or while the instrument is wet may cause an electric shock or a malfunction.

Read this page to ensure proper safety. (Also read the following pages.)



CAUTION (Continued)

- **If not used for a long term, remove the power cord plug of this instrument from the receptacle for safety.**
- **Do not use the instrument without cleaning internal for a long term.**
Long-term use of an instrument having a dirty or dusty interior may cause a fire or malfunction. It is recommended that you contact Iwatsu office or sales distributors to check and clean the interior, calibrate, etc., about once per year.
- **The weight of this instrument is about 43 kg for CS-5200/CS-5300/5400 and about 28 kg for CS-5100. When moving or transporting it, two persons or more should carry it. If not, injury may be caused.**
- **When "OVERHEAT ALERT!!!" or "Overheat alert was detected." is displayed, the inner temperature is high: i.e., overheating state. When the overheating is displayed, stand by for five minutes or more (the time that an in-flight temperature falls enough) after the breaker of "COLLECTOR SUPPLY" is switched to "Disable", and return to "Enable", and restart the measurement. After that, output of current and voltage is automatically set to 0. Wait until the indication disappears while keeping the power on state (fan moving).**
Since the fan moves when the power switch is on, the inner temperature is easy to decrease. If the power switch is turned off, it takes much time to decrease the temperature.
- **Please work carefully so that neither the hand nor the finger, etc. are placed when you handle the lid of the test fixture on.**
It might cause the injuries such as hands and fingers when placed.
- **Please use special red Test Leads in the connection of the collector terminal when you measure high voltage (HIGH VOLTAGE).**
When the Test Leads other than red are used, the resisting voltage might damage the measurement sample and this instrument due to the insufficiency.
- **Do not apply a voltage exceeding 1 kV (500 V for CS-510) or a current exceeding 1 A on each terminals of the test adapters (TO type adapter option) CS-501A , CS-502 (AXIAL type adapter option) and CS-503/CS-504/CS-505/CS-506/CS-510 (SURFACE MOUNT type adapter options). And, do not apply a voltage exceeding 100 V or exceeding 0.5 A on each terminal of the test adapter (SURFACE MOUNT type adapter option) CS-507/CS-509. Moreover, do not apply a voltage exceeding 3 kV or exceeding 40 A on each terminal of the test adapter (SMD CHIP type adapter option) CS-508.**
If the above-mentioned voltage values and current values are exceeded, test adapter instrument or a device to be measured might be damaged.
- **Avoid the measurements of parts other than the semiconductor device because the measurements might cause the breakdown of this instrument and the damage of the measurement device. Moreover, when you measure the semiconductor device that has not been described to this manual, contact Iwatsu office or our sales distributors.**
- **Do not use this instrument by method of no regulations with this instruction manual.**
If not, protection means does not function.

Items

When receiving this instrument, please verify items in the package.

- ◆ Curve Tracer: 1
- ◇ Test fixture
 - CS-303 (for CS-5100 / CS-5200 / CS-5300): 1 set
 - CS-304 (for CS-5400).....: 1 set
- * Either depending on CS-5400 / CS-5300 / CS-5200 or CS-5100

<Accessories>

- Test adapter CS-500 (Blank adapter): 1 set
- Test lead set CS-005: 1 set (7 wires)
 - For collector (voltage and SENSE, red): 2
 - For base (voltage and SENSE, black).....: 2
 - For emitter (voltage and SENSE, green).....: 2
 - For AUX (yellow).....: 1
- HC cable CS-008 (for CS-5400, length: 200 mm): 1 set (2 wires)
- Power cord (3-prong).....: 1
- Cord strap.....: 1
- Instruction Manual (this document): 1
- Instruction Manual and Remote Control Manual (as PDF files in CD): 1

The following options are delivered when the purchase is specified.

- ◆ Option
 - Semiconductor parameter search option CS-800: 1 set
 - DOUBLE SWEEP option CS-801: 1 set
 - * It is delivered simultaneously that two above-mentioned kinds of are optional with the main unit when bought while installed in the main unit. (The USB memory is appended.)
Install, and use the data collected to an attached USB memory when the option is bought after main unit is bought.
 - Test adapter CS-501A (TO type adapter): as requested
 - Insulation tab: 1 piece (with CS-501A)
 - Short-circuit terminal.....: 1 piece (with CS-501A)
 - Test adapter CS-502 (AXIALTO type adapter).....: as requested
 - Test adapter CS-503 (SURFACE MOUNT type adapter).....: as requested
 - Test adapter CS-504 (SURFACE MOUNT type adapter).....: as requested
 - Test adapter CS-505 (SURFACE MOUNT type adapter).....: as requested
 - Test adapter CS-506 (SURFACE MOUNT type adapter).....: as requested
 - Test adapter CS-507 (SURFACE MOUNT type adapter).....: as requested
 - Test adapter CS-508 (SMD CHIP type adapter): as requested
 - Test adapter CS-509 (SURFACE MOUNT type adapter).....: as requested
 - Test adapter CS-510 (SURFACE MOUNT type adapter).....: as requested
 - Alligator clip for curve tracer CS-001 (red).....: as requested (1 set: 10 clips)
 - Alligator clip for curve tracer CS-002 (black).....: as requested (1 set: 10 clips)
 - Test lead set for high voltage CS-003 (red): as requested (1 set: 5 wires)
 - Test lead set CS-004 (black): as requested (1 set: 5 wires)
 - HC cable CS-007 (for CS-5400, length: 300mm)

How to use this document; Notation

It is recommended that the beginner of this instrument should use the instrument after reading this instrument manual carefully.

◆ Explanation of each section

Sections which mainly explain the function, operation, and specification consist of:

◇ Outline (only for Chapter 4)

Inside of the frame describes the purpose, application, and main point (important items in bold and large characters)

◇ Operation procedure

Step-by-step procedure is shown.

◇ Examples of setting and measurement

It includes the operation method, explanation diagram, and detailed explanation.

◇ Warning caution, memo

Warnings and cautions for electric shock, fire, and damage to this instrument are written at the beginning of this manual.

Explanation of each section includes cautions and memo (knowhow and details).

◆ Usage example of caution and memo

◇ Caution

Caution !

When transferring to an environment with different temperature and humidity, sudden temperature change may cause dew condensation. In such a case, this instrument should be inured to the ambient temperature before using it; ambient temperature gradually changes.

◇ Memo

Memo

Kelvin Sense

Since voltage drop caused by the contact resistance of a contact is not included in measurement, high accuracy measurement can be attained.

Updating version of software

Since each software program has suitability to a machine, contact Iwatsu office or our sales distributors for software version update or visit on our Web site (URL : <http://www.iti.iwatsu.co.jp>). For the procedure of the version updating software in the main unit, refer to the section 3.11.1.6 Updating software in the instrument.

Contents

Chapter1 Overview	1-1
1.1 Features.....	1-1
Chapter2 Name and Function of Each Part (Outline).....	2-1
2.1 Name and outline of each part on front panel	2-1
2.1.1 Function keys and FUNCTION knob.....	2-3
2.1.2 STEP GENERATOR	2-4
2.1.3 COLLECTOR SUPPLY	2-5
2.1.4 MEASUREMENT	2-7
2.1.5 DISPLAY	2-8
2.1.6 SYSTEM.....	2-9
2.2 Name and function of each part on rear panel	2-10
2.3 Test fixture CS-303.....	2-11
2.4 Test adapter CS-500 (Blank adapter)	2-13
2.5 Test fixture CS-304.....	2-14
2.6 Test adapter CS-501A (TO type adapter, option)	2-16
2.7 Test adapter CS-502 (Axial type adapter, option).....	2-18
2.8 Test adapter CS-503/CS-504/CS-505 (Surface mount type adapter, option).....	2-20
2.9 Test adapter CS-506 (Surface mount type adapter, option)	2-22
2.10 Test adapter CS-507/CS-509 (Surface mount type adapter, option).....	2-24
2.11 Test adapter CS-508 (SMD CHIP type adapter, option).....	2-26
2.12 Test adapter CS-510 (Surface mount type adapter, option)	2-28
Chapter3 Function Setting and Basic Operation.....	3-1
3.1 Measurement operation flow	3-2
3.2 Setting up this instrument.....	3-3
3.3 Preparation before measurement.....	3-4
3.3.1 Connecting the power cord	3-4
3.3.2 Connecting the test fixture with the main body	3-5
3.3.3 Connecting the patch panel (for CS-303/CS-304)	3-7
3.3.4 Connecting the measured device with the test adapter CS-500.....	3-9
3.3.5 Connecting the measured device with the test adapter CS-501A (Option)	3-10
3.3.6 Connecting the measured device with the test adapter CS-502 (Option).....	3-11
3.3.7 Connecting the measured device with the test adapter CS-503/CS-504/CS-505/CS-506 (Option)	3-12
3.3.8 Connecting the measured device with the test adapter CS-507/CS-509 (Option)	3-14
3.3.9 Connecting the measured device with the test adapter CS-508 (Option).....	3-15
3.3.10 Connecting the measured device with the test adapter CS-510 (Option).....	3-16

3.4	Screen structure	3-17
3.5	Setting with function keys and knobs	3-19
3.6	Setting step generator	3-20
3.6.1	Setting STEP knob	3-21
3.6.2	Setting STEP 1/10 key	3-22
3.6.3	Setting OFFSET knob	3-23
3.6.4	Setting MENU key	3-24
3.7	Setting collector supply.....	3-27
3.7.1	VARIABLE knob	3-29
3.7.2	MODE/POLARITY keys.....	3-30
3.7.3	POWER-WATT key	3-32
3.7.4	VOLTS key	3-33
3.7.5	ACQUIRE key.....	3-34
3.7.6	LOOPING COMPENSATION key	3-37
3.8	Setting measurement	3-38
3.8.1	REPEAT	3-38
3.8.2	SINGLE	3-38
3.8.3	SWEEP.....	3-38
3.9	Setting with HORIZONTAL knob/ VERTICAL knob	3-40
3.9.1	HORIZONTAL knob.....	3-42
3.9.2	VERTICAL knob	3-44
3.10	Setting DISPLAY part menus	3-46
3.10.1	MENU key	3-47
3.10.2	INVERT key.....	3-48
3.10.3	VIEW/PULSE key	3-49
3.10.4	CURSOR key	3-52
3.10.5	ZOOM key	3-57
3.10.6	POSITION key.....	3-58
3.11	Setting SYSTEM part menus.....	3-60
3.11.1	UTILITY key.....	3-61
3.11.2	COPY key.....	3-83
3.11.3	SAVE/RECALL key	3-84
3.11.4	Setting of SAVE/RECALL/DELETE (saving/recalling/deleting data)	3-91
3.11.5	CONFIGURATION key.....	3-99
3.11.6	AUX key.....	3-103
3.11.7	APPLICATION key (option).....	3-104
3.11.8	Default settings.....	3-118
Chapter 4 Characteristics Measurement.....		4-1
4.1	Quick start guide.....	4-2

4.1.1 Diode measurement	4-2
4.1.2 Transistor measurement	4-10
4.1.3 FET measurement.....	4-23
4.2 Characteristics measurement.....	4-34
4.2.1 IGBT characteristics measurement.....	4-34
Chapter5 Daily Maintenance and Calibration	5-1
5.1 Daily maintenance	5-1
5.2 Calibration.....	5-3
5.3 Repair and sending of repaired product.....	5-3
5.4 Storage and transportation.....	5-3
Chapter6 Specifications	6-1
6.1 Product specifications.....	6-1
6.2 Compliance standards.....	6-5
6.3 Outside view	6-6
6.3.1 Main unit (CS-5100)	6-6
6.3.2 Main unit (CS-5200/CS-5300/CS-5400).....	6-6
6.3.3 Test fixture CS-303 (For CS-5100/CS-5200/CS-5300).....	6-7
6.3.4 Test adapter CS-500 (Blank adapter)	6-8
6.3.5 Test fixture CS-304 (For CS-5400)	6-9
6.3.6 Test adapter CS-501A (TO type adapter, option)	6-10
6.3.7 Test adapter CS-502 (Axial type adapter, option).....	6-11
6.3.8 Test adapter CS-503 (Surface Mount type adapter, option)	6-12
6.3.9 Test adapter CS-504 (Surface Mount type adapter, option)	6-13
6.3.10 Test adapter CS-505 (Surface Mount type adapter, option).....	6-14
6.3.11 Test adapter CS-506 (Surface Mount type adapter, option).....	6-15
6.3.12 Test adapter CS-507 (Surface Mount type adapter, option).....	6-16
6.3.13 Test adapter CS-508 (SMD CHIP type adapter, option).....	6-17
6.3.14 Test adapter CS-509 (Surface Mount type adapter, option).....	6-18
6.3.15 Test adapter CS-510 (Surface Mount type adapter, option).....	6-19

Memo

Chapter1 Overview

Development of semiconductor technologies is remarkable and diverse; in particular, components including power devices such as inverters are expanding and progress in the technology for them is striking in such facilities as heavy electrical equipment (electric power), home electric products, air conditioning, and traffic. In power electronics technologies, existing pursuit of high efficient use of power is changing to pursuit of reduced energy density (compacting) or ECO gentle to the environments. Part development for ECO products is progressing rapidly in transportation industries such as electric train, automobile industries, and power device manufacturers.

Inverter technologies used in various electronic components such as the air conditioner, refrigerator, elevator, electric train, hybrid car, solar power generation, and wind power generation are essential for saving energy. Importance of evaluating power semiconductor devices is increasing to improve the efficiency in use of energy.

The Curve Tracer CS-5000 series have been improved further for the power of CS-3000 and have been developed to evaluate power semiconductor devices in such a power electronics market. Section 1.1 below shows features of CS-5000 series.

1.1 Features

The Curve Tracer CS-5000 series are the instrument which can support up to the maximum peak voltage of 5000V and the maximum peak current of 1.5kA. It can be used not only for characteristics measurement of high-voltage or high-current power devices such as the latest IGBT and power MOSFET but also for characteristics measurement of various semiconductor devices such as transistors, diode, and LEDs. The measurement results can be saved in the memory or sent to the PC through the USB port and LAN interface which are attached as standard. Main features are as follows:

* CS-5000 series include 4 models: CS-5100, CS-5200, CS-5300 and CS-5400.

■ Peak voltage

All models of CS-5000 series have the maximum peak voltage of 5000 V for collector supply.

■ High current mode installed (Except for CS-5100)

Models of CS-5200/CS-5300/CS-5400 install the high current mode (HC mode)

- CS-5200: Up to **maximum collector current of 400 A**
- CS-5300: Up to **maximum collector current of 1000 A**
- CS-5400: Up to **maximum collector current of 1500 A**

■ All models have 4 collector supply modes.

They have 4 collector supply modes: AC, full-wave rectified, DC, and leakage current as standard.

CS-5200 and CS-5300 can supply the **maximum of 40 V pulse**, and **CS-5400** can supply the **maximum of 30 V pulse** in the high current mode (HC mode).

■ Handling a measured device

A measured device is set in either of two methods below:

- Connect the terminals of a measured device to the specified terminals in the test adapter, and set the test adapter in the test fixture. There are CS-500 of standard equipment and CS-501A to CS-510 options in test adaptors. Refer to Section 2.3 to Section 2.12 for details.
- Connect the terminals of a measured device directly to the specified terminals of the test fixture through the dedicated Test Leads. (Refer to Section 2.3 section for details only when you use test fixture CS-302.)

The test fixture with the measured device mounted is connected to the main unit through the cable and the connector box. (For details, see Section 3.3.)

■ Remote control function

CS-5000 series supports LAN interface (10 Base-T/100 Base-TX Ethernet). External connection uses LAN terminal on the rear panel. For details; e.g., usage and commands, see Remote Control Manual recorded in the attached CD.

Chapter 2 Name and Function of Each Part (Outline)

This section outlines the name and the function of each part in this instrument.

Section 2.1 and Section 2.2 briefly explain names and functions of keys and connections on the front and rear panels.

Section 2.3 to Section 2.10 briefly explain names and functions of parts on the test fixture and the test adapter.

2.1 Name and outline of each part on front panel

Figure 2.1 shows the front panel of CS-5400 and Table 2.1 lists name and function of each part.

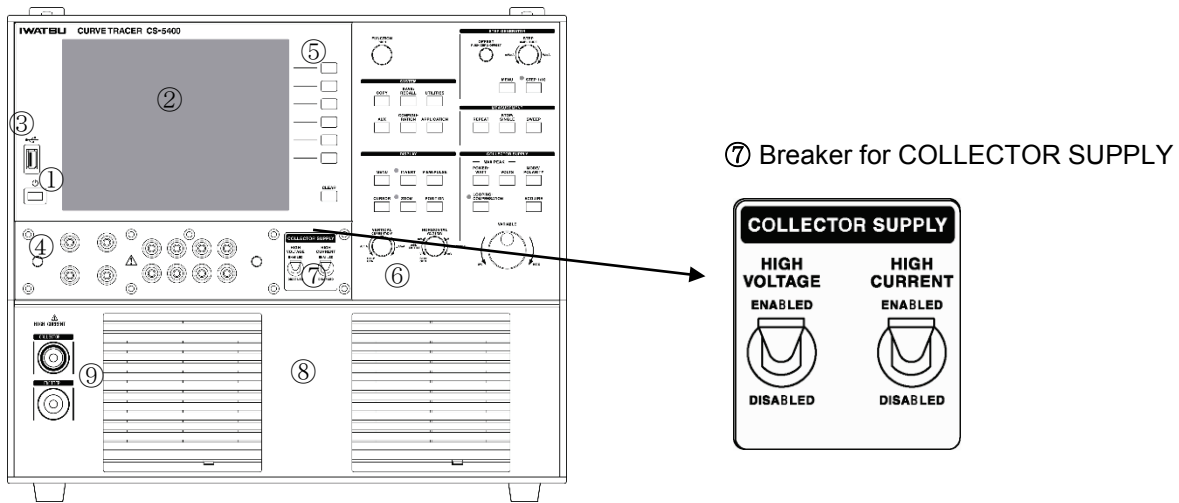

Figure 2.1 Front panel of CS-5400

Figure 2.2 shows the front panel of CS-5200/CS-5300 and Table 2.1 lists name and function of each part. Each part of ① -⑦ is common by four models in each figure. CS-5100 doesn't have part ⑧ HIGH CURRENT compared with CS-5400. CS-5200/CS-5300 have part ⑧ HIGH CURRENT, but don't have ⑨ HIGH CURRENT high current connector.

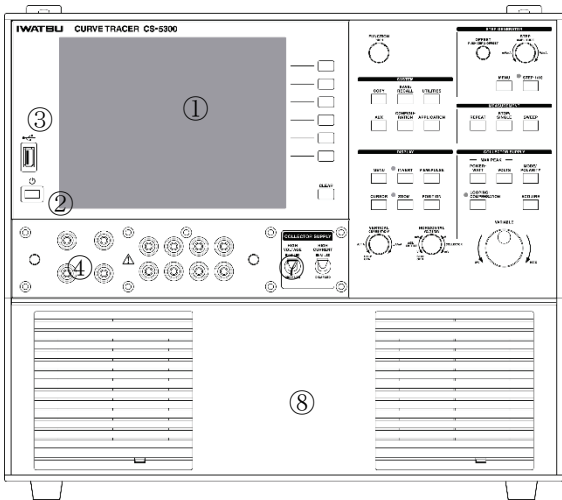

Figure 2.2 Front panel of CS-5200/CS-5300

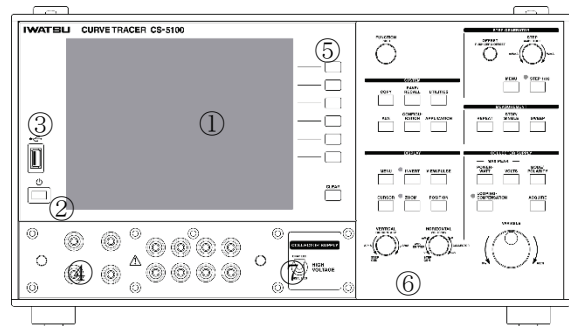

Figure 2.3 Front panel of CS-5100

Table 2.1 Name and function of each part on front panel

No	Name	Description
①	LCD screen	8.4-inch color LCD. It displays various setting screens and menus.
②	Power supply switch	It switches On/Standby.
③	USB terminal	Terminal to input/output data from/to USB memory. It can be used for saving/recalling setup data (setting conditions) and waveform data (TRACE/REF), and screen hard copy. (For handling USB memory, see Section 3.11.)
④	Input/output terminals	They connect the test fixture through the connector box.
⑤	Function keys CLEAR key	On the right side of LCD, keys below are arranged in sequence from the top. <ul style="list-style-type: none"> • Function keys: F1 to F6 from the top • CLEAR key It is used to eliminate the function menu. However, if the submenu appears, it allows the submenu to return to the previous menu.
⑥	Various menu keys	Various menu keys are arranged. For these keys, see Section 2.1.1 to Section 2.1.6.
⑦	Breaker for COLLECTOR SUPPLY	It switches ENABLED/ DISABLED for the collector supply output with the breaker switch (upper diagram) for protection of a measured device from overcurrent/overvoltage. When DISABLED, the menu can be set but nothing is generated and measured. If ENABLED, measurement can be made. CS-5100 : only HIGH VOLTAGE CS-5200/5300/5400 : both HIGH VOLTAGE & HIGH CURRENT
⑧	HIGH CURRENT	Included in CS-5200/5300/5400. (Not included in CS-5100.)
⑨	HIGH CURRENT Connector terminal	Included in only CS-5400. (Not included in CS-5100/5200/5300.) The HC cable of the test fixture CS-304 is connected with the HIGH CURRENT connector terminal.

2.1.1 Function keys and FUNCTION knob

Figure 2.4 shows function keys and FUNCTION knob on the front panel and Table 2.2 lists name and function of each part. (The explanation of this chapter is common for four models though Figure 2.4 is a front panel of CS-5400.)

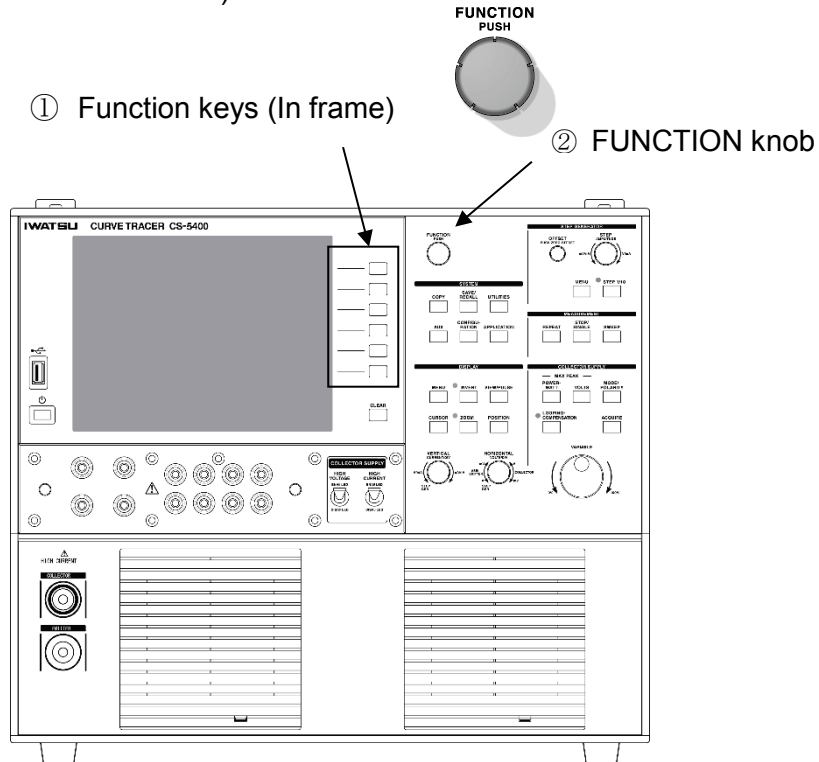



Figure 2.4 Front panel (function keys, FUNCTION knob)

Table 2.2 Front panel (function keys, FUNCTION knob)

No	Name	Description	Ref.
①	Function keys	Keys to select submenus displayed on the right side on the LCD. The surface of these keys on the panel shows no character but they are called "Function keys" in this manual (F1 to F6 from the top). Pressing one of them allows the corresponding submenu to open and the corresponding function to be carried out.	Section 3.5
②	FUNCTION knob	FUNCTION knob is used to select submenus on the right side on the LCD when the function menu is selected. It is available only when icon  appears on the submenu. Pushing FUNCTION knob allows transfer among base steps and switchover of a side to be moved during cursor measurement.	Section 3.5

2.1.2 STEP GENERATOR

Figure 2.5 shows the STEP GENERATOR part on the front panel and Table 2.3 lists the name and function of each part.

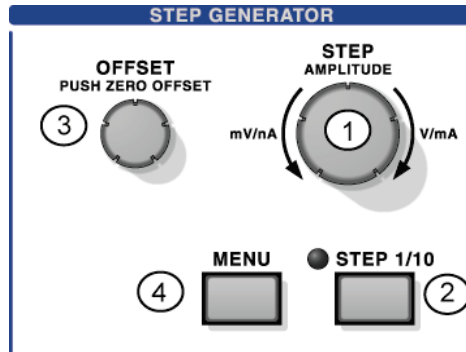

Figure 2.5 Front panel (STEP GENERATOR part)

Table 2.3 Front panel (STEP GENERATOR part)

No	Name	Description	Ref.
①	STEP AMPLITUDE key	It sets the voltage/current value per step for the step generator output.	Section 3.6
②	STEP 1/10 key	It sets the voltage/current value per step for the step generator output to 1/10. The lamp of STEP 1/10 goes on.	Section 3.6.2
③	OFFSET key	It sets the offset of the step generator output. Pushing it allows the offset value to return to zero.	Section 3.6.3
④	MENU key STEP PULSE SOURCE NUMBER OF STEPS SWEEP STEPS NEXT PAGE /PREV PAGE OFFSET MODE	It sets the step generator output condition. It selects polarity of STEP waveform (+STEP, -STEP). It selects polarity of PULSE waveform (+PULSE, -PULSE). It selects step voltage or step current. It sets the number of steps for output waveform. It sets the number of measurement points per step for the step generator SWEEP. It displays the 2nd page menu when setting to PULSE. It displays the 1st page menu. It changes the offset mode; i.e., offset is added to the entire pulse steps or each pulse step. It is available when STEP is set to PULSE.	Section 3.6.4 Section 3.6.4.2

2.1.3 COLLECTOR SUPPLY

Figure 2.6 show COLLECTOR SUPPLY part on the front panel and Table 2.4 lists name and function of each part.

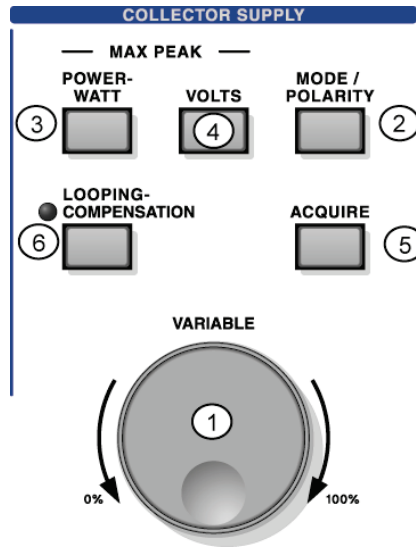

Figure 2.6 Front panel (COLLECTOR SUPPLY part)

Table 2.4 Name and function of each part on front panel (COLLECTOR SUPPLY part)

No	Name	Description	Ref.
①	VARIABLE knob	It sets the output voltage of the collector supply, using the ratio (percentage) to the MAX PEAK VOLTAGE setting value.	Section 3.7.1
②	MODE / POLARITY key HIGH VOLTAGE / HIGH CURRENT AC RECTIFIED SINE DC LEAKAGE	It sets items below on MODE/POLARITY menu: It sets HIGH VOLTAGE mode or HIGH CURRENT mode. (Only HIGH VOLTAGE mode is set for CS-5100.) It sets the sine wave. It sets + full-wave rectified/ - full-wave rectified. It sets + DC/ - DC. It sets + LEAKAGE/ -LEAKAGE.	Section 3.7.2
③	POWER-WATT key	It sets the maximum peak power to be applied to a measured device on MAX PEAK POWER WATTS menu.	Section 3.7.3
④	VOLTS key	It sets the maximum peak voltage to be applied to a measured device on MAX PEAK VOLTAGE menu.	Section 3.7.4
⑤	ACQUIRE key HIGH VOLTAGE mode SINE FREQUENCY SWEEP STEPS SWEEP TYPE SWEEP END VARIABLE	It sets items below on ACQUIRE menu: It sets the measurement frequency (50 Hz/60 Hz) in AC and SINE (full-wave rectified). It sets the number of measurement points per step in collector SWEEP. (Available when STEP of STEP GENERATOR is set to PULSE.) It sets SWEEP direction. It sets the voltage for SWEEP, using the ratio (%) to MAX PEAK VOLTAGE. Validity / invalidity changes by setting SWEEP TYPE.	Section 3.7.5

Chapter 2 Name and Function of Each Part (Outline)

	<p>SET CURRENT VARIABLE</p> <p>SWEEP WAIT TIME</p> <p>HIGH CURRENT mode</p> <p>PULSE INTERVAL</p> <p>SWEEP STEPS</p> <p>SWEEP TYPE</p> <p>SWEEP END VARIABLE</p> <p>SET CURRENT VARIABLE</p> <p>SWEEP WAIT TIME</p>	<p>Pressing the function key on the right of the menu allows the current VARIABLE setting value to be set to SWEEP END VARIABLE.</p> <p>It can set the waiting time, in SWEEP operation, after a voltage changes in VARIABLE until next data is acquired. (It is available when, e.g., measurement considers the influence of time constant on a measured device.)</p> <p>(This mode is not set for CS-5100.)</p> <p>It sets the interval of the collector output pulse</p> <p>It sets the number of measurement points per step in collector SWEEP. (In HIGH CURRENT mode, STEP of STEP GENERATOR is specified to PULSE.)</p> <p>It sets SWEEP direction.</p> <p>It sets the voltage for SWEEP, using the ratio (%) to MAX PEAK VOLTAGE. Validity / invalidity changes by setting SWEEP TYPE.</p> <p>Pressing the function key on the right of the menu allows the current VARIABLE setting value to be set to SWEEP END VARIABLE.</p> <p>It can set the waiting time, in SWEEP operation, after a voltage changes in VARIABLE until next data is acquired. (It is available when, e.g., measurement considers the influence of time constant on a measured device.)</p>	
<p>⑥</p>	<p>LOOPING-COMPENSATION key</p> <p>HARDWARE COMPENSATION</p> <p>SOFTWARE COMPENSATION</p>	<p>It compensates the floating capacity included in the test texture, connection cable, Test Lead, and others when connecting a measured device.</p> <p>When using the software looping, the lamp turns on (other than 0%).</p> <p>It sets items below on LOOPING-COMPENSATION menu:</p> <p>It sets the numeric value of setting range (%).</p> <p>It sets the numeric value of setting range (%).</p>	<p>Section 3.7.6</p>

2.1.4 MEASUREMENT

Figure 2.7 shows MEASUREMENT part on the front panel and Table 2.5 lists name and function of each part.

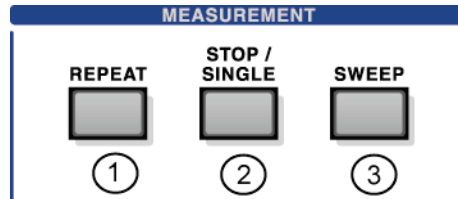

Figure 2.7 Front panel (MEASUREMENT part)

Table 2.5 Name and function of each part on front panel (MEASUREMENT part)

No	Name	Description	Ref.
①	REPEAT	It allows measurement to repeat.	Section 3.8.1
②	STOP/SINGLE	It allows the step generator to output the signal of the setting number of steps only once and measurement to be done. After completion of measurement, the step generator stops. It ends the REPEAT measurement and the SWEEP measurement, and put into the state of STOP.	Section 3.8.2
③	SWEEP	If the step generator is set to PULSE and the horizontal axis range is set to COLLECTOR/BASE-EMITTER, SWEEP is available. For collector supply SWEEP, SWEEP being arbitrarily set between the collector supply VARIABLE setting value and 0% is used for measurement. For step generator SWEEP, SWEEP being arbitrarily set between the maximum and minimum (offset setting value) values of a step signal is used for measurement.	Section 3.8.3

2.1.5 DISPLAY

Figure 2.8 show DISPLAY part on the front panel and Table 2.6 lists name and function of each part.

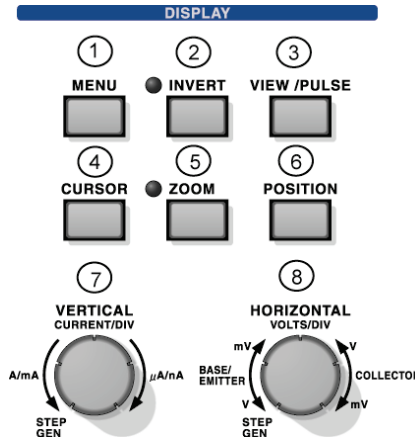

Figure 2.8 Front panel (DISPLAY part)

Table 2.6 Name and function of each part on front panel (DISPLAY part)

No	Name	Description	Ref.
①	MENU key VECTOR AVERAGE PERSISTENCE REF VIEW SAVE REF	It selects whether spaces between data pieces are interpolated with straight lines when being displayed or only data is displayed with dots without interpolation. It sets the number of AVERAGES (OFF, 2 to 255). It sets the persistence display time. It displays the waveform saved in REF number in white. It saves the currently displayed waveform in REF number.	Section 3.10.1
②	INVERT key/lamp	It switches reversed waveform display/not reversed. The lamp turns on for reversed display.	Section 3.10.2
③	VIEW / PULSE key VIEW MODE WAVE 1st WAVE 2nd PULSE WIDTH MEASUREMENT POINT	It switches TRACE/WAVE. It selects Ic → Vce → Vbe of waveform in sequence which is displayed on the WAVE 1st It selects Ic → Vce → Vbe of waveform in sequence which is displayed on the WAVE 2nd. It sets the output pulse width of the step generator. (Available only when the submenu STEP is set to +PULSE/-PULSE) It can arbitrarily set the timing to measure the output pulse from the step generator in 10μs step. (Available only when the submenu STEP is set to +PULSE/-PULSE)	Section 3.10.3
④	CURSOR key	It sets cursor OFF, DOT cursor, fLINE cursor, FREE cursor, or WINDOW cursor. It also selects the display renewal rate (FAST, MID, SLOW).	Section 3.10.4
⑤	ZOOM key/lamp	The screen is enlarged with the setting magnification using the middle on the screen as the center. When ZOOM is set to ON, the lamp turns on.	Section 3.10.5
⑥	POSITION key	It sets the origin of trace in horizontal and vertical direction.	Section 3.10.6
⑦	HORIZONTAL VOLTS/DIV	It sets the horizontal range (VOLTS/DIV) of the screen and the source (STEP, BASE-EMITTER, and COLLECTOR).	Section 3.9.1
⑧	VERTICAL CURRENT/DIV	It sets the vertical range (CURRENT/DIV) of the screen and the source (STEP, EMITTER, and COLLECTOR).	Section 3.9.2

2.1.6 SYSTEM

Figure 2.9 shows SYSTEM part on the front panel and Table 2.7 lists name and function of each part.

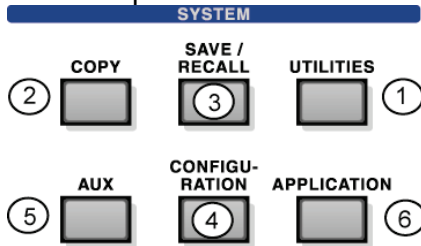

Figure 2.9 Front panel (SYSTEM part)

Table 2.7 Name and function of each part on front panel (SYSTEM part)

No.	Name	Description	Ref.
①	UTILITIES key REMOTE CONTROL HARD COPY INTENSITY SYSTEM SETUP SYSTEM TOOLS	It displays REMOTE CONTROL setting menu which are used through LAN. It sets the file name, file type, background color, and color of the image data generated by COPY key. It sets the brightness of a waveform, grid, cursor, REF, BACK LIGHT. It sets the beep sound, setting when being powered on (SETUP), selection of header display information, setting for panel lock and setting concerning various measurements. It displays the system information, initializes all internal settings, updates software, and installs options.	Section 3.11.1
②	COPY key	It outputs the image data into the USB memory connected to the USB terminal.	Section 3.11.2
③	SAVE/RECALL key	It saves (SAVE)/recalls (RECALL)/deletes (DELETE) data from/to the internal memory/USB memory.	Section 3.11.3 3.11.4, 3.11.8
④	CONFIGURATION key	There are 7 connection patterns: i.e., combination of collector/ base/ emitter terminals and collector supply, step generator, and Common. Selection from 7 patterns is available.	Section 3.11.5
⑤	AUX key	It sets ON/OFF of output to the auxiliary output voltage (AUX terminal) and the voltage value.	Section 3.11.6
⑥	APPLICATION key (option) Vth /hFE SETUP LIMIT SWEEP CONSTANT VOLTAGE / CURRENT COLLECTOR SWEEP DOUBLE	Functions using APPLICATION key require options. Installation of them from USB memory allows application functions. Three of Vth /hFE SETUP, LIMIT SWEEP, and CONSTANT VOLTAGE / CURRENT in four following kinds can be measured by using Semiconductor parameter search option CS-800. COLLECTOR SWEEP DOUBLE can be measured by using DOUBLE SWEEP option CS-801. It sets the function which automatically measures semiconductor parameters such as the threshold voltage (Vth) of MOS transistor and the amplification factor (hFE) of the bipolar transistor. It sets function which automatically stop SWEEP at the specified voltage/current. It is the effective function to make long observation for reliability and stability of the semiconductor device. Measurement makes either parameter of Vce and IC constant. It is a function to observe the characteristic of the semiconductor devices such as hysteresis. SWEEP can be measured by turning continuously in the image like start point A⇒UP SWEEP⇒ turning point B⇒DOWN SWEEP⇒ start point A.	Section 3.11.7 3.11.7.1 3.11.7.2 3.11.7.3 3.11.7.4

2.2 Name and function of each part on rear panel

Figure 2.10 (a) shows the rear panel of CS-5200/5300/5400 and Figure 2.10 (b) shows the rear panel of CS-5100 and Table 2.8 lists name and function of each part.

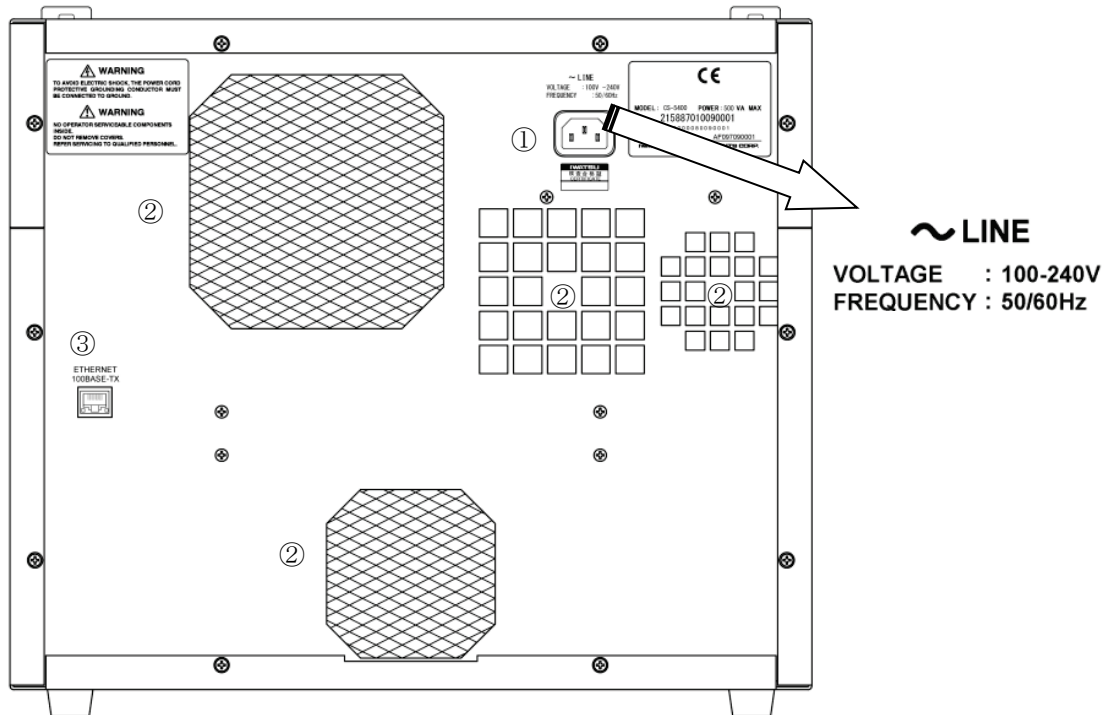

Figure 2.10 (a) Rear panel of CS-5200/5300/5400

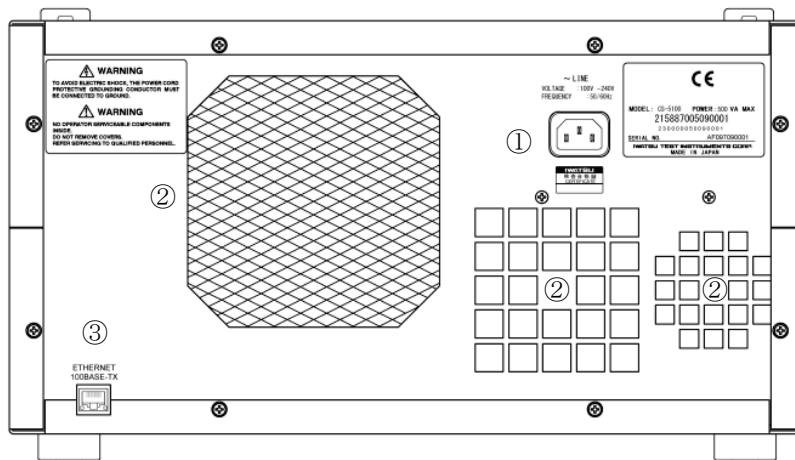

Figure 2.10 (b) Rear panel of CS-5100

Table 2.8 Name and function of each part on rear panel of CS-5200/5300/5400

No	Name	Description
①	AC LINE INPUT terminal	AC power input part. It connects the attached 3-prong power supply cord. The power supply specification (see the enlarged diagram) is described to connected prologue.
②	Exhaust opening	The outside air is sucked from the openings on the both sides and discharged from it.
③	ETHERNET terminal	LAN connector connection terminal to connect this instrument with the external controller through Ethernet. Specification: 10 Base-T / 100Base-TX Ethernet

2.3 Test fixture CS-303

Figure 2.11 show the patch panel part on the test fixture CS-303 of this instrument and Table 2.9 on next page lists name and function of each part. CS-303 is the test fixture for CS-5100/5200/5300.

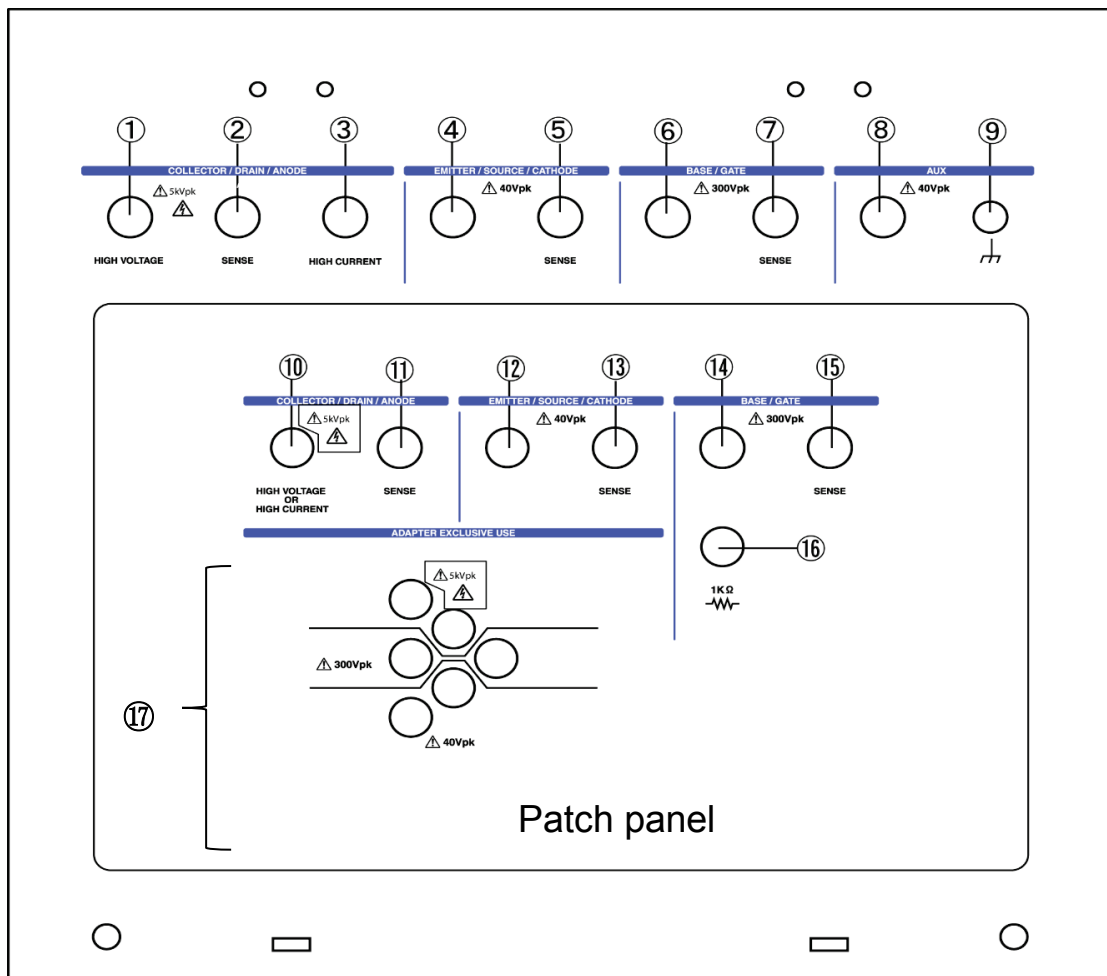

Figure 2.11 Name and function of each part on test fixture CS-303

CAUTION ! About the caution marks and the voltages that display in the panel and the patch panel of the test fixture

Missing proper wiring and/or wrong connection may conduct wrong measurement. Also these connections may cause of damage on DUT and/or malfunction of the unit.

Case1: Wrong connection between Collector terminal and Base terminal;

DUT may be damaged while extra high voltage can be supplied on Base terminal.

Case2: NOT connecting Collector output terminal, Base output terminal and/or Emitter terminal and connecting Collector sense terminal, Base sense terminal and/or Emitter sense terminal respectively;

It may cause for burn of SENSE RESISTERS inside of the unit since the sense resistors connected to outputs respectively for Kelvin sensing and may be supplied current exceeding each specification.

Case3: Connecting HIGH VOLTAGE terminal and HIGH CURRENT terminal of collector output at the same time on DUT;

It may be cause for fire and/or malfunction due to high voltage applied to HIGH CURRENT terminal.

Table 2.9 Name and function of each part on test fixture CS-303

The terminal since ⑩ is terminals in the patch panel of test fixture CS-303 among in the table below. When the test adaptor is used, the patch panel should be necessary, and the terminal since these ⑩ be connected.

No.	Name	Description	Ref.
①	COLLECTOR SUPPLY HIGH VOLTAGE	Output terminal of the collector supply during high-voltage mode	Section 3.7
②	COLLECTOR SUPPLY SENSE	Kelvin sense terminal of the collector supply	Section 3.7
③	COLLECTOR SUPPLY HIGH CURRENT	Output terminal of the collector supply during high current mode	Section 3.7
④	EMITTER/SOURCE/CATHODE	Output terminal of emitter/source/cathode	Section 3.7
⑤	EMITTER/SOURCE/CATHODE SENSE	Kelvin sense terminal of emitter/source/cathode	Section 3.7
⑥	BASE/GATE	Output terminal of step signal	Section 3.6
⑦	BASE/GATE SENSE	Kelvin sense terminal of step signal	Section 3.6
⑧	AUX	Output terminal of external output voltage	Section 3.11.6
⑨	AUX GROUND	Ground terminal of external output voltage	Section 3.11.6
⑩	COLLECTOR SUPPLY, HIGH VOLTAGE OR HIGH CURRENT	It connects to ① COLLECTOR SUPPLY HIGH VOLTAGE or ③ COLLECTOR SUPPLY HIGH CURRENT.	Section 3.7
⑪	COLLECTOR SUPPLY SENSE	It connects to the ② COLLECTOR SUPPLY SENSE.	Section 3.7
⑫	EMITTER/SOURCE/CATHODE	It connects to ④ EMITTER/SOURCE/CATHODE.	Section 3.7
⑬	EMITTER/SOURCE/CATHODE SENSE	It connects to ⑤ EMITTER/SOURCE/CATHODE SENSE	Section 3.7
⑭	BASE/GATE	It connects to ⑥ BASE/GATE	Section 3.6
⑮	BASE/GATE SENSE	It connects to ⑦ BASE/GATE SENSE	Section 3.6
⑯	BASE/GATE 1k Ω	It makes the internal connection through the base terminal of ⑰ and 1k Ω resistance. Connect it with the output terminal of ⑥ step signal instead of ⑭ when using it.	Section 3.3
⑰	ADAPTER EXCLUSIVE USE	These are terminals that install the test adapter.	Section 3.3

2.4 Test adapter CS-500 (Blank adapter)

Blank adapter is an adapter for the customer freely to connect, and to measure the device.

Figure 2.12 shows the test adapter CS-500 (Blank adapter) of this instrument and Figure 2.13 shows the adapter attached to the patch panel. Table 2.10 lists name and function of each part. S-500 can be mounted on either of test fixtures CS-303 and CS-304.

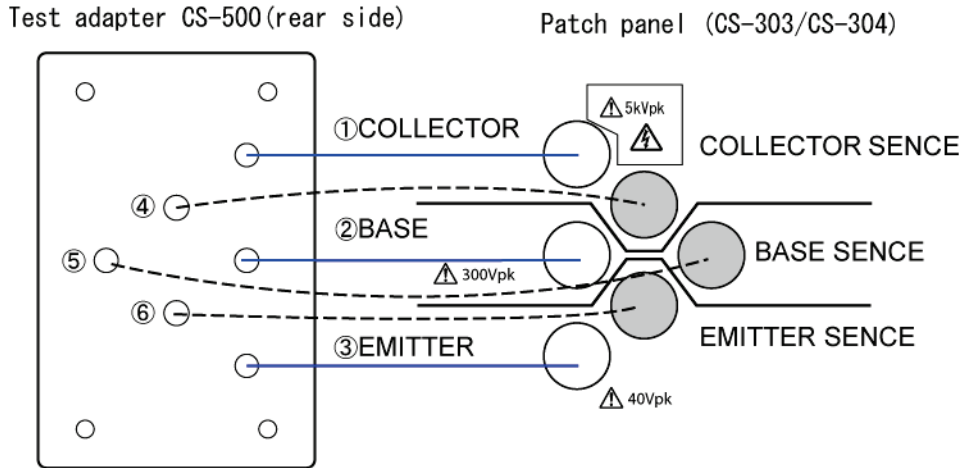

Figure 2.12 Test adapter CS-500 (Blank adapter)

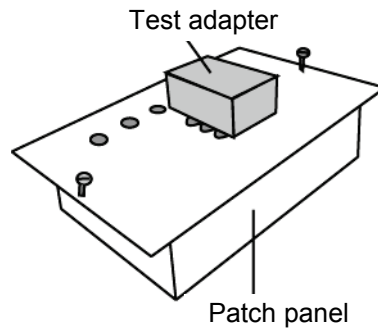

Figure 2.13 Test adapter CS-500 (Blank adapter) attached to patch panel

Table 2.10 Test adapter CS-500 (Blank adapter)

No	Name	Description	Ref.
①	Collector	It connects the collector of a measured device or equivalent terminal.	Section 3.3.4
②	Base	It connects the base of a measured device or equivalent terminal.	Section 3.3.4
③	Emitter	It connects the emitter of a measured device or equivalent terminal.	Section 3.3.4
④	Collector Sense	It connects the collector of a measured device or equivalent terminal.	Section 3.3.4
⑤	Base Sense	It connects the base of a measured device or equivalent terminal.	Section 3.3.4
⑥	Emitter Sense	It connects the emitter of a measured device or equivalent terminal.	Section 3.3.4

Note: Connect each Sense terminal of above-mentioned ④ to ⑥. Especially, if connection to SENSE terminal is not made in HIGH CURRENT mode, measurement cannot be done.

2.5 Test fixture CS-304

Figure 2.14 shows the patch panel part on the test fixture CS-304 of this instrument and Table 2.11 on next page lists name and function of each part. CS-304 is the test fixture for only CS-5400.

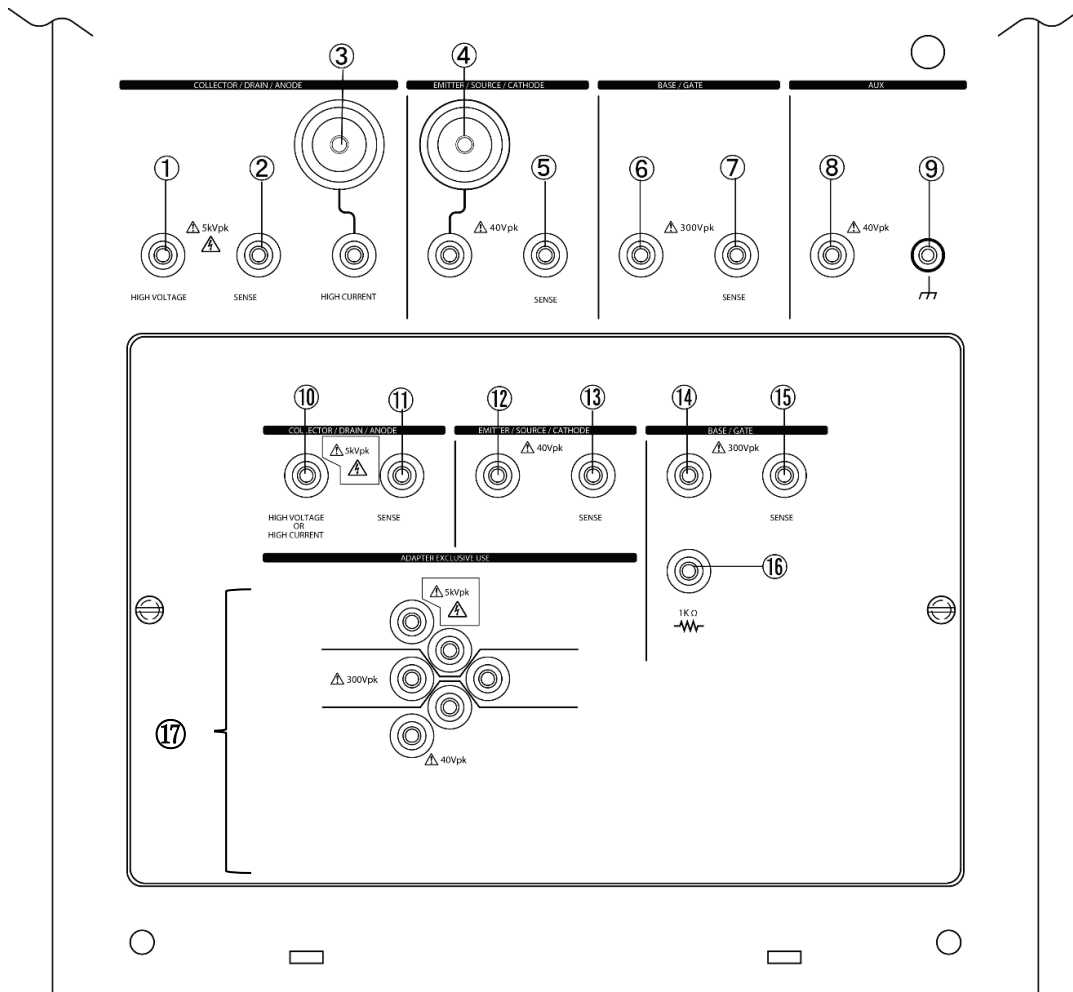

Figure 2.14 Name and function of each part on test fixture CS-304

CAUTION ! About the caution marks and the voltages that display in the panel and the patch panel of the test fixture

Missing proper wiring and/or wrong connection may conduct wrong measurement. Also these connections may cause of damage on DUT and/or malfunction of the unit.

Case1: Wrong connection between Collector terminal and Base terminal;

DUT may be damaged while extra high voltage can be supplied on Base terminal.

Case2: NOT connecting Collector output terminal, Base output terminal and/or Emitter terminal and connecting Collector sense terminal, Base sense terminal and/or Emitter sense terminal respectively;

It may cause for burn of SENSE RESISTERS inside of the unit since the sense resistors connected to outputs respectively for Kelvin sensing and may be supplied current exceeding each specification.

Case3: Connecting HIGH VOLTAGE terminal and HIGH CURRENT terminal of collector output at the same time on DUT;

It may be cause for fire and/or malfunction due to high voltage applied to HIGH CURRENT terminal.

Table 2.11 Name and function of each part on test fixture CS-304

The terminal since ⑩ is terminals in the patch panel of test fixture CS-304 among in the table below. When the test adaptor is used, the patch panel should be necessary, and the terminal since these ⑩ be connected.

No.	Name	Description	Ref.
①	COLLECTOR SUPPLY HIGH VOLTAGE	It is an output terminal of the collector supply at the HIGH VOLTAGE mode.	Section 3.7
②	COLLECTOR SUPPLY SENSE	It is a Kelvin Sense terminal of the collector supply	Section 3.7
③	COLLECTOR SUPPLY HIGH CURRENT	It is an output terminal of the collector supply at the HIGH CURRENT mode. - The screw terminal (It is a big connector terminal in Figure 2.14) is used at the measurement that should set MAX PEAK CURRENT to 1.5 kA. - When measuring in the situation except that MAX PEAK CURRENT is not 1.5 kA, either of screw terminal / banana terminal can be used. - HC cable option CS-007 can be used for the connection of the thing to be measured and this terminal.	Section 3.7
④	EMITTER/SOURCE/CATHODE	It is an output terminal in emitter/source/cathode at the HIGH CURRENT mode. - The screw terminal (It is a big connector terminal in Figure 2.14) is used at the measurement that should set MAX PEAK CURRENT to 1.5 kA. - When measuring in the situation except that MAX PEAK CURRENT is not 1.5 kA, either of screw terminal / banana terminal can be used. - HC cable option CS-007 can be used for the connection of the thing to be measured and this terminal.	Section 3.7
⑤	EMITTER/SOURCE/CATHODE SENSE	It is a Kelvin Sense terminal of emitter / source / cathode.	Section 3.7
⑥	BASE/GATE	It is an output terminal of the step signal.	Section 3.6
⑦	BASE/GATE SENSE	It is a Kelvin Sense terminal of the step signal.	Section 3.6
⑧	AUX	Output terminal of external output voltage	Section 3.11.6
⑨	AUX GROUND	Ground terminal of external output voltage	Section 3.11.6
⑩	COLLECTOR SUPPLY, HIGH VOLTAGE OR HIGH CURRENT	It mitigates the shock when the upper cover is closed.	Section 3.7
⑪	COLLECTOR SUPPLY SENSE	It connects with the ① HIGH VOLTAGE or ③ HIGH CURRENT.	Section 3.7
⑫	EMITTER/SOURCE/CATHODE	It connects with the output terminal in emitter / source / cathode of ④.	Section 3.7
⑬	EMITTER/SOURCE/CATHODE SENSE	It connects with the Kelvin Sense terminal of ⑤.	Section 3.7
⑭	BASE/GATE	It connects with the output terminal in the step signal of ⑥.	Section 3.6
⑮	BASE/GATE SENSE	It connects with the Kelvin Sense terminal of ⑦.	Section 3.6
⑯	BASE/GATE 1kΩ	It is connected internally through the base terminal of ⑰ and the resistance of 1kΩ.	Section 3.3
⑰	ADAPTER EXCLUSIVE USE	These are terminals that install the test adapter.	Section 3.3

2.6 Test adapter CS-501A (TO type adapter, option)

Figure 2.15 shows the test adapter CS-501 A (front side) of this instrument and Figure 2.16 shows the connection diagram between the test adapter CS-501A (rear side) and the patch panel. The summary about part names and functions is presented in Table 2.12 of next page. The test adapter CS-501A (TO type adapter) is the optional instrument and can be mounted on either of test fixtures CS-303 and CS-304. One insulation tab (Figure 2.15) is attached to test adaptor CS-501A. (When buying it, insulation tab is inserted in the socket of ② or ③ of Figure 2.15 like the dotted line.)

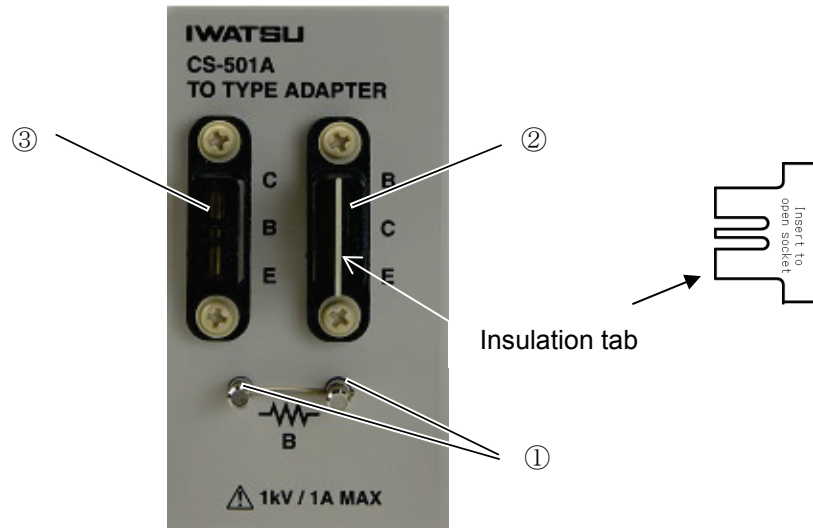

Figure 2.15 Test adapter CS-501A (front side)

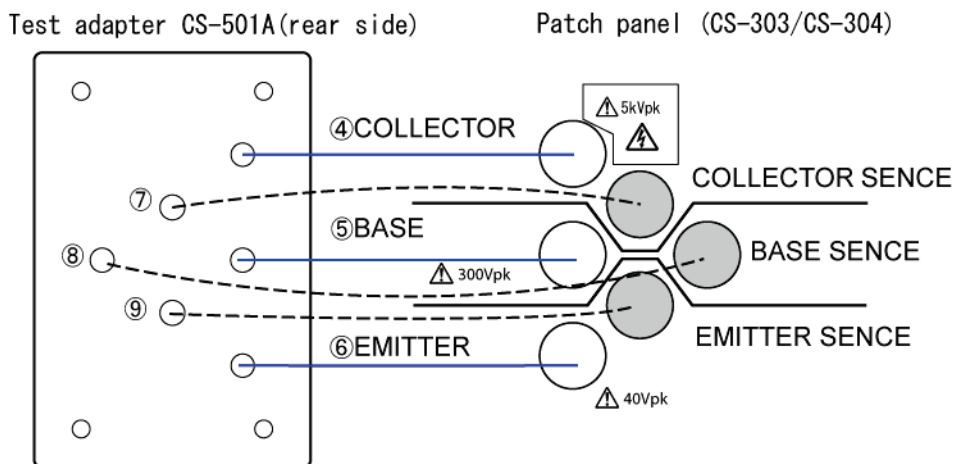

Figure 2.16 Test adapter CS-501A (rear side) attached to the patch panel

Table 2.12 Name and function of each part on test adapter CS-501A (TO type adapter)

No.	Name	Description	Ref.
①	Base resistance	It certainly connects either the resistance element or the short-circuit terminal.	Section 3.3.5
②	Sockets for element: B C E	It connects the element arranged in the order of the base, collector, and emitter. The groove in the center connects the terminal of a measured element or the insulation tab.	Section 3.3.5
③	Sockets for element: C B E	It connects the element arranged in the order of the collector, base, and emitter. The groove in the center connects the terminal of a measured element or the insulation tab.	Section 3.3.5
④ ⑦	Collector Collector sense	It connects with the collector (C) of the socket of ① or ② in Figure 2.15.	Section 3.3.5
⑤ ⑧	Base Base sense	By way of base resistance, it connects with the base (B) of the socket of ① or ② in Figure 2.15. It connects with the base (B) of the socket of ① or ② in Figure 2.15.	Section 3.3.5
⑥ ⑨	Emitter Emitter sense	It connects with the emitter (E) of the socket of ① or ② in Figure 2.15.	Section 3.3.5

Caution!

- Do not apply a voltage exceeding 1 kV or a current exceeding 1 A to each terminal of the test adapter (TO TYPE ADAPTER) CS-501A.

If 1 kV or 1 A is exceeded, test adapter or a measured device might be damaged.

- For an accurate measurement, insert an accessory insulation tab in the socket (② or ③ of Figure 2.15) that doesn't connect the measurement element while measuring.

Memo

- It is not possible to measure at the same time though two kinds of devices to be measured can be installed in test adaptor CS-501A. Measure by installing one device to be measured and one insulation tab.

2.7 Test adapter CS-502 (Axial type adapter, option)

Figure 2.17 shows the test adapter CS-502 (front side) of this instrument and Figure 2.18 shows the connection diagram between the test adapter CS-502 (rear side) and the patch panel. The summary about part names and functions is presented in Table 2.13 of next page. The test adapter CS-502 (AXIAL type adapter) is the optional instrument and can be mounted on either of test fixtures CS-303 or CS-304.

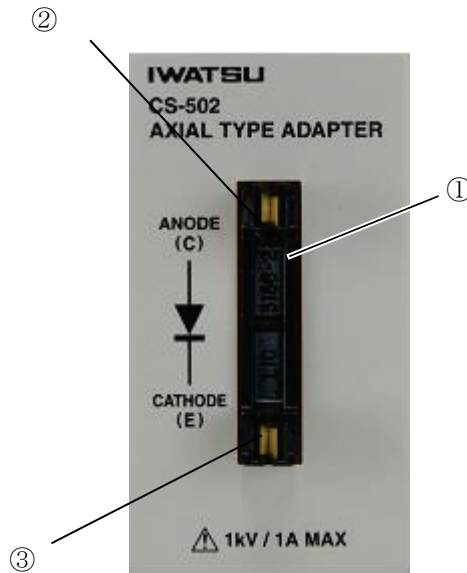

Figure 2.17 Test adapter CS-502 (front side)

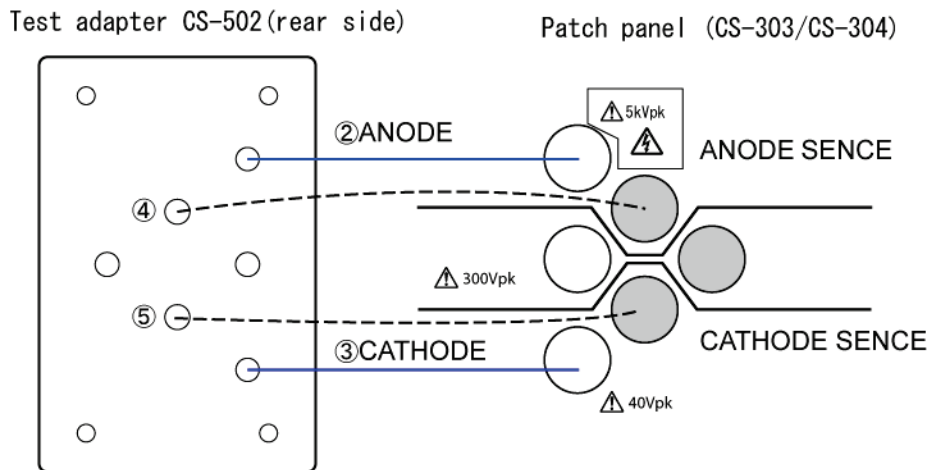

Figure 2.18 Test adapter CS-502 (rear side) attached to the patch panel

Table 2.13 Name and function of each part on test adapter CS-502 (Axial type adapter)

No.	Name	Description	Ref.
①	Socket for element	It connects the element of axial type.	Section 3.3.6
② ④	ANODE (C) ANODE (C) SENSE	It connects with the ANODE (C) of the socket of ① in Figure 2.17.	Section 3.3.6
③ ⑤	CATHODE (E) CATHODE (E) SENSE	It connects with the CATHODE (E) of the socket of ① in Figure 2.17.	Section 3.3.6

Caution!

- Do not apply a voltage exceeding 1 kV or a current exceeding 1 A to each terminal of the test adapter (Axial type adaptor) CS-502.

If 1 kV or 1 A is exceeded, test adapter or a measured device might be damaged.

2.8 Test adapter CS-503/CS-504/CS-505 (Surface mount type adapter, option)

Figure 2.19 shows the front side of test adapters CS-503, CS-504 and CS-505 of this instrument and Figure 2.20 shows the connection diagram between the test adapter CS-503 (Rear side and CS-504 and CS-505 are the same configurations.) and the patch panel.

The summary about three kinds of part names and functions is presented in Table 2.14, Table 2.15 and Table 2.16 of next page.

The test adapters CS-503 (TO-263-3 type adapter), CS-504 (TO-252-3 type adapter) and CS-505 (TO-263-7 type adapter) are the optional instruments and can be mounted on either of test fixtures CS-303 or CS-304.

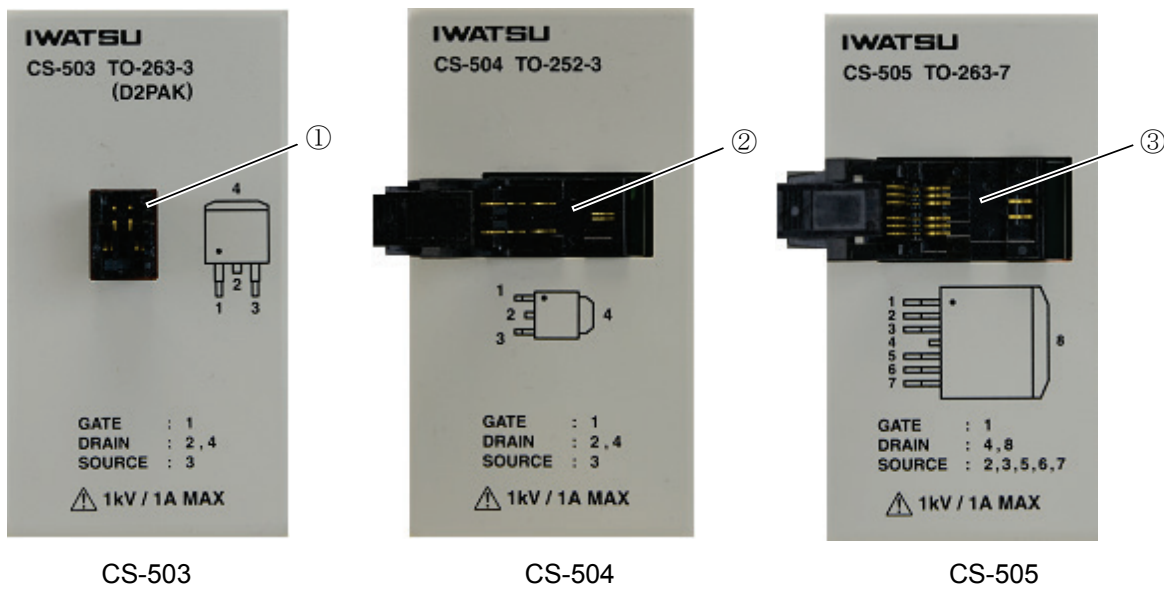

Figure 2.19 Test adapter CS-503/CS-504/CS-505 (front side)

Test adapter CS-503 (rear side)

CS-504 and CS-505 are the same config. Patch panel (CS-303/CS-304)

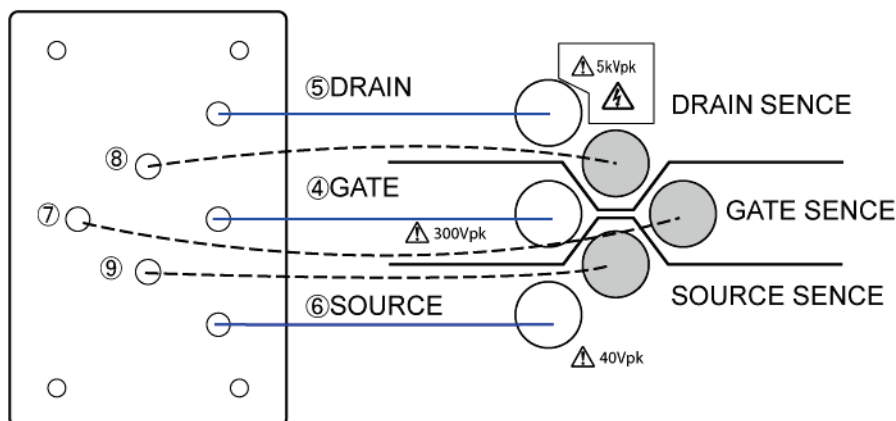

Figure 2.20 Test adapter CS-503 (rear side) attached to the patch panel

Table 2.14 Name and function of each part on test adapter CS-503 (TO-263-3 type adapter)

No.	Name	Description	Ref.
①	Socket for element GDS	It corresponds to the element of package TO-263-3(D2PAK) type. It mounts the array element of GATE, DRAIN and SOURCE from the left on the socket.	Section 3.3.7
④ ⑦	GATE GATE SENSE	It connects with the GATE of the socket of ① in Figure 2.19.	Section 3.3.7
⑤ ⑧	DRAIN DRAIN SENSE	It connects with the DRAIN of the socket of ① in Figure 2.19.	Section 3.3.7
⑥ ⑨	SOURCE SOURCE SENSE	It connects with the SOURCE of the socket of ① in Figure 2.19.	Section 3.3.7

Table 2.15 Name and function of each part on test adapter CS-504 (TO-252-3 type adapter)

No.	Name	Description	Ref.
②	Socket for element GDS	It corresponds to the element of package TO-252-3 type. It mounts the array element of GATE, DRAIN and SOURCE from the interior on the socket.	Section 3.3.7
④ ⑦	GATE GATE SENSE	It connects with the GATE of the socket of ② in Figure 2.19.	Section 3.3.7
⑤ ⑧	DRAIN DRAIN SENSE	It connects with the DRAIN of the socket of ② in Figure 2.19.	Section 3.3.7
⑥ ⑨	SOURCE SOURCE SENSE	It connects with the SOURCE of the socket of ② in Figure 2.19.	Section 3.3.7

Table 2.16 Name and function of each part on test adapter CS-505 (TO-263-7 type adapter)

No.	Name	Description	Ref.
③	Socket for element GDS	It corresponds to the element of package TO-263-7 type. It mounts the array element of GATE, DRAIN and SOURCE from the interior on the socket.	Section 3.3.7
④ ⑦	GATE GATE SENSE	It connects with the GATE of the socket of ③ in Figure 2.19.	Section 3.3.7
⑤ ⑧	DRAIN DRAIN SENSE	It connects with the DRAIN of the socket of ③ in Figure 2.19.	Section 3.3.7
⑥ ⑨	SOURCE SOURCE SENSE	It connects with the SOURCE of the socket of ③ in Figure 2.19.	Section 3.3.7

Caution!

- Do not apply a voltage exceeding 1 kV or a current exceeding 1 A to each terminal of the test adapter CS-503, CS-504 and CS-505.

If 1 kV or 1 A is exceeded, test adapter or a measured device might be damaged.

2.9 Test adapter CS-506 (Surface mount type adapter, option)

Figure 2.21 shows the front side of test adapters CS-506 of this instrument and Figure 2.22 shows the connection diagram between the test adapter CS-506 (rear side) and the patch panel. The summary about part names and functions is presented in Table 2.17 of next page. Only the drain terminal fixes the pin assign to this product. The pin assign of the gate terminal and the source terminal will correspond after hearing the customer's demand to the shipment. The test adapter CS-506 (TO-252-5 type adapter) is the optional instrument and can be mounted on either of test fixtures CS-303 or CS-304.

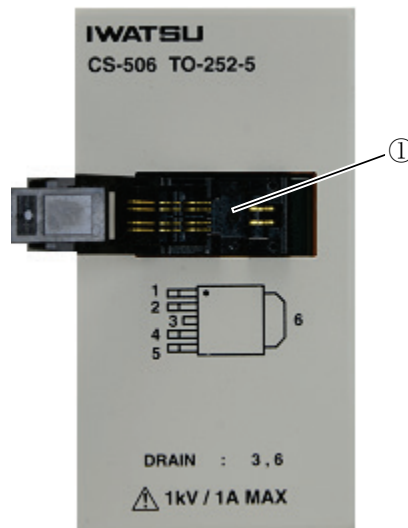

Figure 2.21 Test adapter CS-506 (front side)

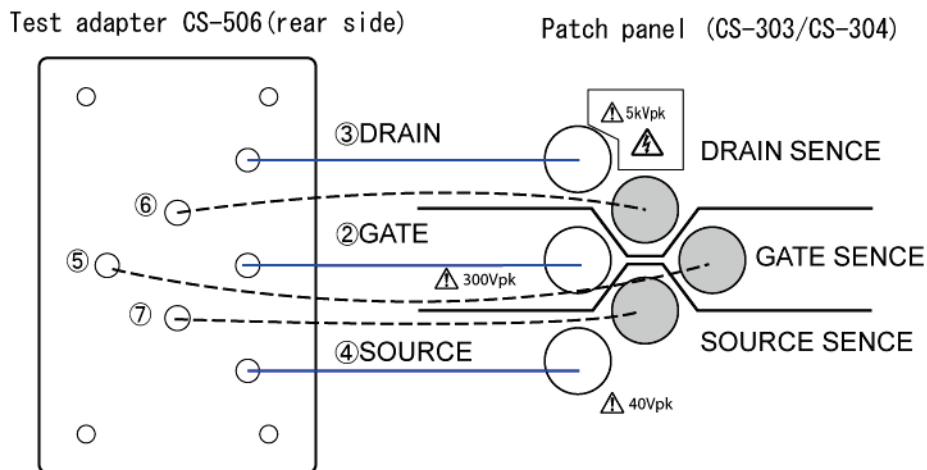

Figure 2.22 Test adapter CS-506 (rear side) attached to the patch panel

Table 2.17 Name and function of each part on test adapter CS-506 (TO-252-5 type adapter)

No.	Name	Description	Ref.
①	Socket for element	It corresponds to the element of package TO-252-5 type. It opens and shuts the lid of the socket, and mounts the element corresponding to arbitrary pin assign.	Section 3.3.7
② ⑤	GATE GATE SENSE	It connects with the pin set to GATE of the socket of ① in Figure 2.21.	Section 3.3.7
③ ⑥	DRAIN DRAIN SENSE	It connects with the DRAIN of the socket of ① in Figure 2.21.	Section 3.3.7
④ ⑦	SOURCE SOURCE SENSE	It connects with the pin set to SOURCE of the socket of ① in Figure 2.21.	Section 3.3.7

Caution!

- Do not apply a voltage exceeding 1 kV or a current exceeding 1 A to each terminal of the test adapter CS-506.
If 1 kV or 1 A is exceeded, test adapter or a measured device might be damaged.

2.10 Test adapter CS-507/CS-509 (Surface mount type adapter, option)

Figure 2.23 and 2.24 show the front side of test adapters CS-507 and CS-509 of this instrument and Figure 2.25 shows the connection diagram between the test adapter CS-507 (rear side) and the patch panel. The summary about part names and functions is presented in Table 2.18 of next page.

The test adapter CS-507 (SC-70-3 type adapter) and CS-509 (SC-59A type adapter) are optional instruments and can be mounted on either of test fixtures CS-303 or CS-304.

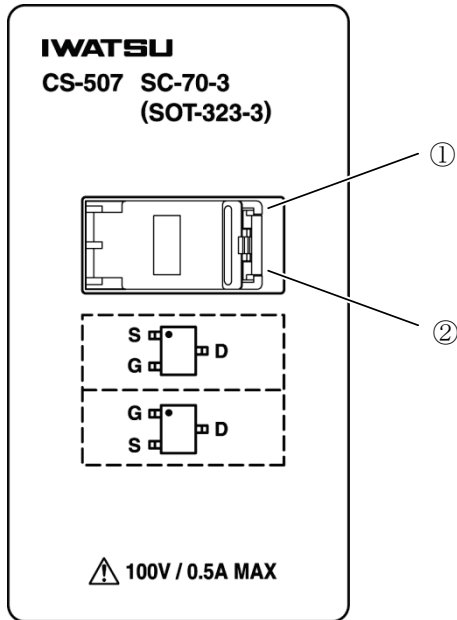

Figure 2.23 Test adapter CS-507 (front side)

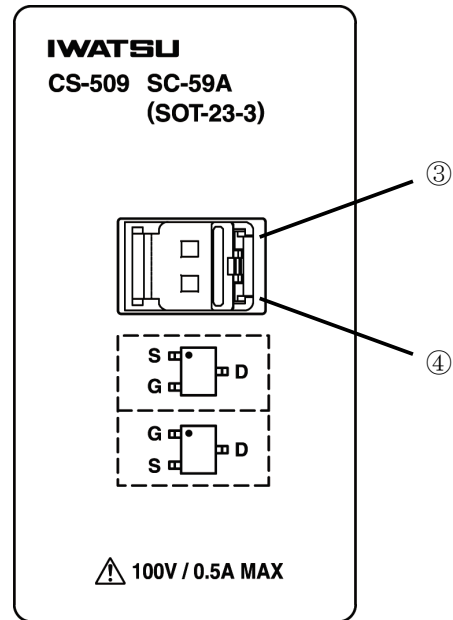

Figure 2.24 Test adapter CS-509 (front side)

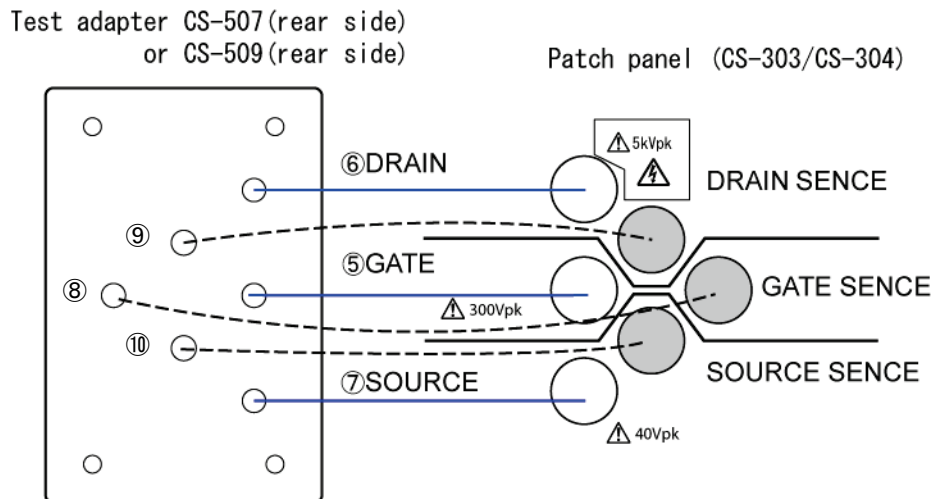

Figure 2.25 Test adapter CS-507 or CS-509 (rear side) attached to the patch panel

Table 2.18 Name and function of each part on test adapter CS-507 (SC-70-3 type adapter)

No.	Name	Description	Ref.
①	Socket for element SDG	It corresponds to the element of package SC-70-3 (SOT-323-3) type. It mounts the array element of SOURCE, DRAIN and GATE from the interior on the socket.	Section 3.3.8
②	Socket for element GDS	It corresponds to the element of package SC-70-3 (SOT-323-3) type. It mounts the array element of GATE, DRAIN and SOURCE from the interior on the socket.	Section 3.3.8
⑤ ⑧	GATE GATE SENSE	It connects with the pin set to GATE of the socket of ①, ② in Figure 2.23.	Section 3.3.8
⑥ ⑨	DRAIN DRAIN SENSE	It connects with the pin set to DRAIN of the socket of ①, ② in Figure 2.23.	Section 3.3.8
⑦ ⑩	SOURCE SOURCE SENSE	It connects with the pin set to SOURCE of the socket of ①, ② in Figure 2.23.	Section 3.3.8

Table 2.19 Name and function of each part on test adapter CS-509 (SC-59A type adapter)

No.	Name	Description	Ref.
③	Socket for element SDG	It corresponds to the element of package SC-59A (SOT-23-3) type. It mounts the array element of SOURCE, DRAIN and GATE from the interior on the socket.	Section 3.3.8
④	Socket for element GDS	It corresponds to the element of package SC-59A (SOT-23-3) type. It mounts the array element of GATE, DRAIN and SOURCE from the interior on the socket.	Section 3.3.8
⑤ ⑧	GATE GATE SENSE	It connects with the pin set to GATE of the socket of ③, ④ in Figure 2.24.	Section 3.3.8
⑥ ⑨	DRAIN DRAIN SENSE	It connects with the pin set to DRAIN of the socket of ③, ④ in Figure 2.24.	Section 3.3.8
⑦ ⑩	SOURCE SOURCE SENSE	It connects with the pin set to SOURCE of the socket of ③, ④ in Figure 2.24.	Section 3.3.8

Caution!

- Do not apply a voltage exceeding 100 V or a current exceeding 0.5 A to each terminal of the test adapter CS-507 and CS-509.
If 100 V or 0.5 A is exceeded, test adapter or a measured device might be damaged.

Memo

- It is not possible to measure at the same time though two kinds of devices to be measured can be installed in test adaptor CS-507 and CS-509. Measure by installing only one device to be measured.

2.11 Test adapter CS-508 (SMD CHIP type adapter, option)

Figure 2.26 shows the front side of test adapters CS-508 of this instrument and Figure 2.27 shows the example of shape of SMD CHIP. The summary about part names and functions is presented in Table 2.20 of next page.

Test adapter CS-508 (SMD CHIP test adapter) is an option and can be attached to test fixture CS-303 or CS-304 with the screws for the fixation of both ends instead of the patch panel.

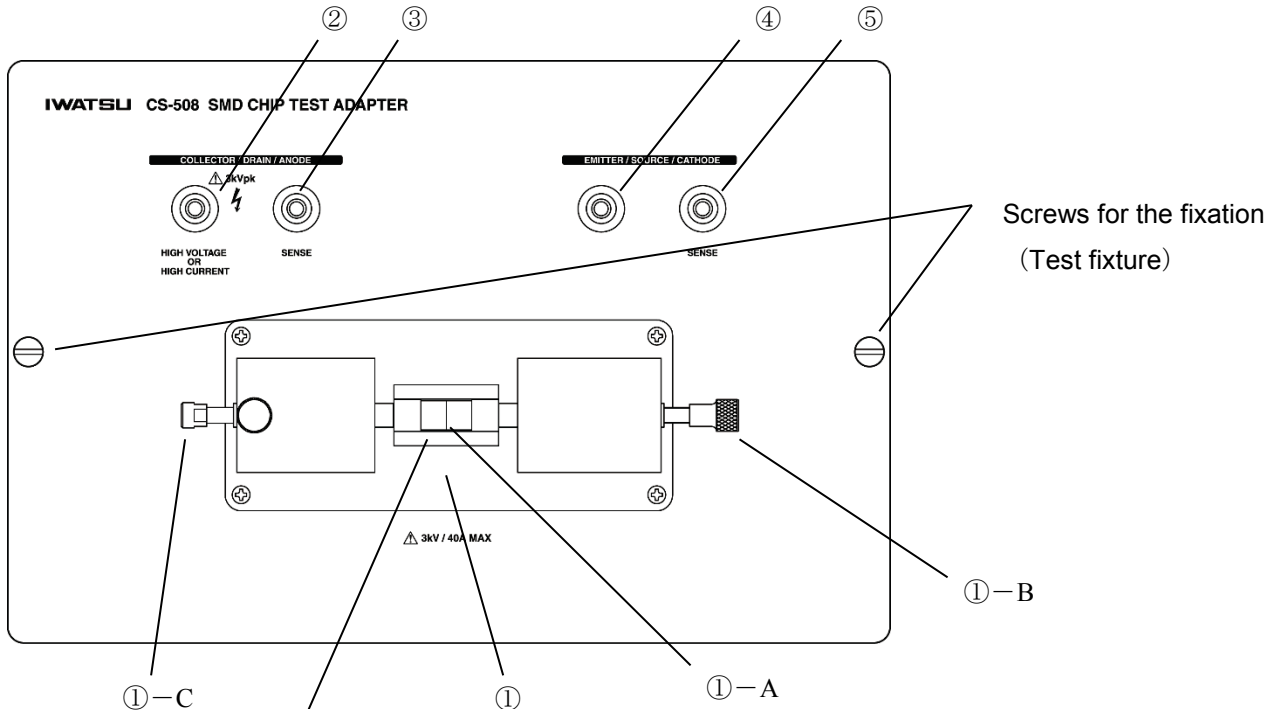

* Attach in the following direction.

Left toward the applied part of ①-A: ANODE

Right toward the applied part of ①-A: CATHODE

Figure 2.26 Test adapter CS-508



Figure 2.27 Example of shape of SMD CHIP

CAUTION ! About the caution marks and the voltages that display in the panel and the patch panel of the test fixture

Missing proper wiring and/or wrong connection may conduct wrong measurement. Also these connections may cause of damage on DUT and/or malfunction of the unit.

Case: NOT connecting Collector output terminal and Emitter terminal and connecting Collector sense terminal and Emitter sense terminal respectively;

It may cause for burn of SENSE RESISTER inside of the unit since the sense resister connected to output of Collector output for Kelvin sensing and may be supplied exceeded current specification.

Table 2.20 Name and function of each part on test adapter CS-508 (SMD CHIP type adapter)

No.	Name	Description	Ref.
①	Socket for element	Fix, and connect the element of the SMD CHIP type like figure 2.25.	Section 3.3.9
①-A	Element installation part	Put the SMD CHIP type element.	—
①-B	Knob with spring	Pull the part of the knob right, and place the element by the power of the spring.	—
①-C	Positional fixed knob	When a knob alone with the spring doesn't wake up, an upward screw (white) is loosened, the knob is pulled left, and the position is adjusted, and tighten and fix the screw (white).	—
② ③	COLLECTOR/DRAIN/ANODE SENSE	Connect it with the terminal that corresponds to COLLECTOR/DRAIN/ANODE of the test fixture.	Section 3.3.9
④ ⑤	EMITTER/SOURCE/CATHODE SENSE	Connect it with the terminal that corresponds to EMITTER/SOURCE/CATHODE of the test fixture.	Section 3.3.9

Caution!

- Do not apply a voltage exceeding 3 kV or a current exceeding 40 A to each terminal of the test adapter CS-508.

If 3 kV or 40 A is exceeded, test adapter or a measured device might be damaged.

2.12 Test adapter CS-510 (Surface mount type adapter, option)

Figure 2.28 shows the front side of test adapters CS-510 of this instrument and Figure 2.29 shows the connection diagram between the test adapter CS-510 (rear side) and the patch panel. The summary about part names and functions is presented in Table 2.21 of next page.

The test adapter CS-510 (SC-62 type adapter) is the optional instrument and can be mounted on either of test fixtures CS-303 or CS-304.

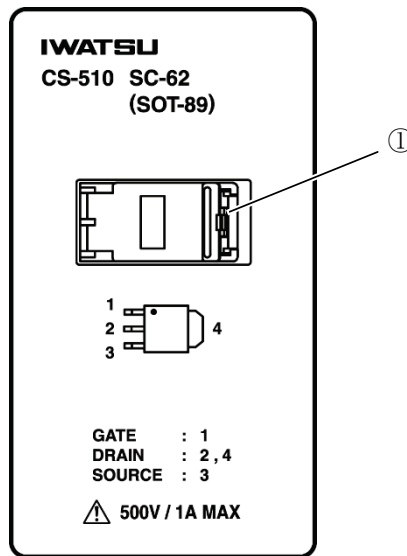

Figure 2.28 Test adapter CS-510 (front side)

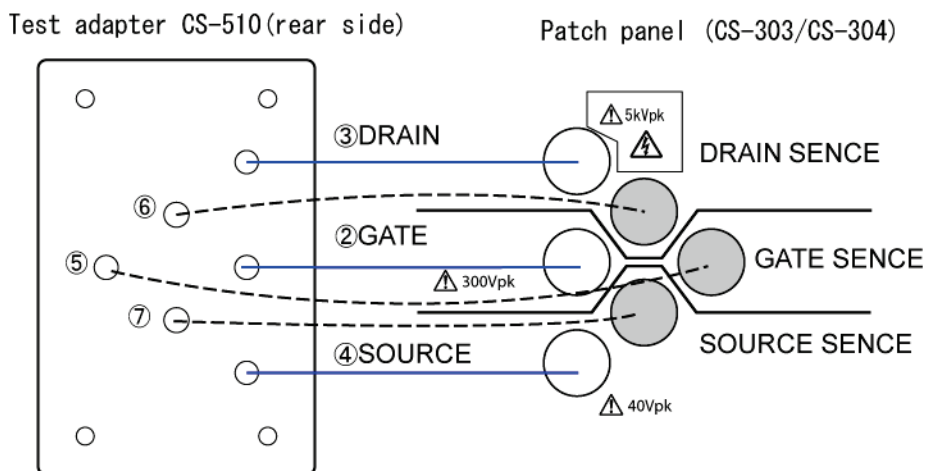

Figure 2.29 Test adapter CS-510 (rear side) attached to the patch panel

Table 2.21 Name and function of each part on test adapter CS-510 (SO-62 type adapter)

No.	Name	Description	Ref.
①	Socket for element GDS	It corresponds to the element of package SC-62 (SOT-89) type. It mounts the array element of SOURCE, DRAIN and GATE from the interior on the socket.	Section 3.3.10
② ⑤	GATE GATE SENSE	It connects to GATE of the socket of ① in Figure 2.28.	Section 3.3.10
③ ⑥	DRAIN DRAIN SENSE	It connects to DRAIN of the socket of ① in Figure 2.28.	Section 3.3.10
④ ⑦	SOURCE SOURCE SENSE	It connects to SOURCE of the socket of ① in Figure 2.28.	Section 3.3.10

Caution!

- Do not apply a voltage exceeding 500 V or a current exceeding 1 A to each terminal of the test adapter CS-510.

If 500 V or 1 A is exceeded, test adapter or a measured device might be damaged.

Memo

Chapter 3 Function Setting and Basic Operation

Section 3.1 of this chapter shows the flow of measurement and reference information.

Section 3.2 explains cautions when setting up this instrument.

Section 3.3 explains preparation before measurement; i.e., power cord connection, connection between the test fixture and this instrument, patch panel connection, connection of a device to be measured.

Section 3.4 shows the screen structure and displayed contents, and reference information.

Section 3.5 to Section 3.11 explain functions of keys and knobs, their relationship to menus, related information, and basic operation for each operation part on the front panel as shown in the diagram below:

- Section 3.1 Measurement operation flow
- Section 3.2 Setting up this instrument
- Section 3.3 Preparation before measurement
- Section 3.4 Screen structure
- Section 3.5 Setting with function keys and knobs
- Section 3.6 Setting step generator
- Section 3.7 Setting collector supply
- Section 3.8 Setting measurement
- Section 3.9 Setting with HORIZONTAL knob/ VERTICAL knob
- Section 3.10 Setting display menus
- Section 3.11 Setting system menus

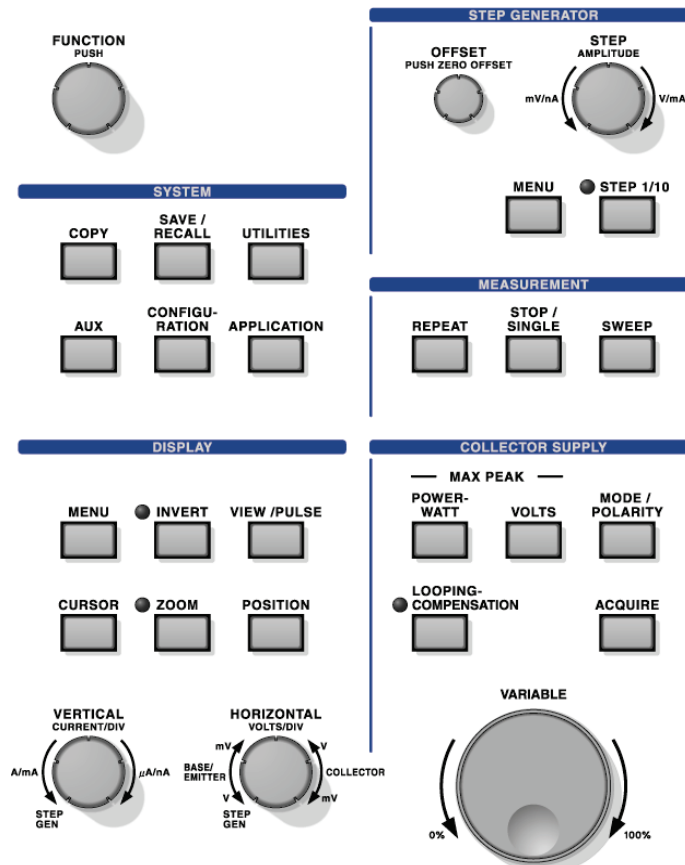

3.1 Measurement operation flow

The measurement operation flow below allows the beginner of the CS-5000 series to easily understand the flow of the entire operation. For details of each item, see description of functions and operation in each chapter and each section.

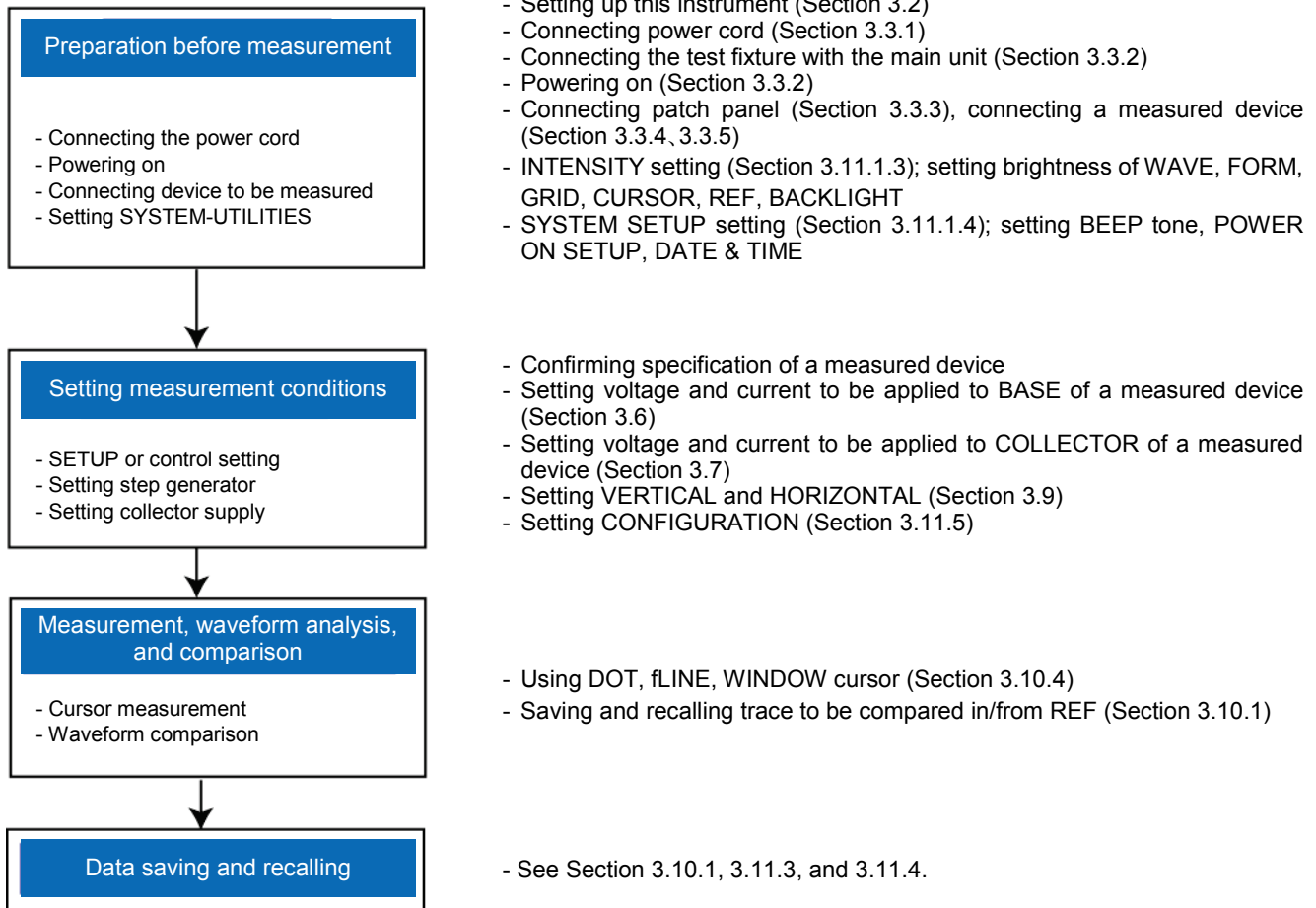

3.2 Setting up this instrument

Set up this instrument in the location and environment which satisfy conditions below:

★ Flat and horizontal surface

Set up this instrument on the stable surface while keeping it horizontal in all directions. If not, it may fall or come down, resulting in injury to your body or damage to this instrument.

If installing it on the rack, the rack should be selected in accordance with the size of this instrument: CS-5100: width: 424 mm, depth: 555 mm, and height: 220 mm;

CS-5200/CS-5300/CS-5400: width: 424 mm, depth: 555 mm, and height: 354 mm (excluding attachment and projection).

★ Well ventilated location

There are the air hole on each side of this instrument and (CS-5200/CS-5300/CS-5400 have another air hole at the lower part on the front) and the exhaust hole on the rear. To prevent the temperature in this instrument from increasing, there should be sufficient spaces around it and the air holes and the exhaust hole should not be obstructed. Recommended spaces are sized 100mm each for left side, right side and rear of this instrument.

* CS-5200/CS-5300/CS-5400 have the filter attached to the air hole on the front panel. For cleaning the filter, see Section 5.1 "Cleaning dust filter" of Chapter 5.

★ **Specification ensured temperature, operation ensured temperature and humidity**

Specification ensured temperature range:

+10°C to +35°C (without dew condensation)

Operation ensured temperature and humidity range:

0°C to +40°C,

5% to 80%RH (at 30°C or less) and no dew condensation allowed

Upper limit: 55%RH (at 40 °C) and no dew condensation allowed

Caution !

When transferring to an environment with different temperature and humidity, sudden temperature change may cause dew condensation. In such a case, this instrument should be inured to the ambient temperature before using it; ambient temperature gradually changes.

3.3 Preparation before measurement

This section explains steps until displaying the initial screen; i.e., connecting the power cord, connecting the test fixture, powering on, and connecting a device to be measured. (This section uses CS-5200/5300/5400 for explanation and the same steps are used for CS-5100.)

3.3.1 Connecting the power cord

For warnings and cautions for power supply connection and the power cord, see pages ii to viii at the beginning of this document. Be sure to read them before connecting the power supply. ① and ② below describe the procedure for connecting the power supply. (This section explains only procedure for CS-5200/5300/5400 which is the same as that for CS-5100.)

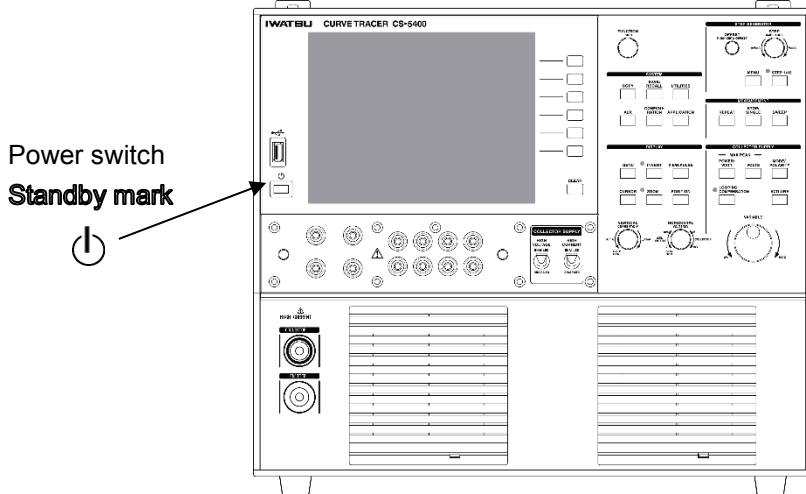

Figure 3.1 Front panel CS-5200/CS-5300/CS-5400

- ① Insert the plug of the attached power cord into AC LINE INPUT terminal for the power cord connection on the rear panel (Figure 3.2).
- ② Connect the other plug of the power cord to the power supply socket (Figure 3.2).

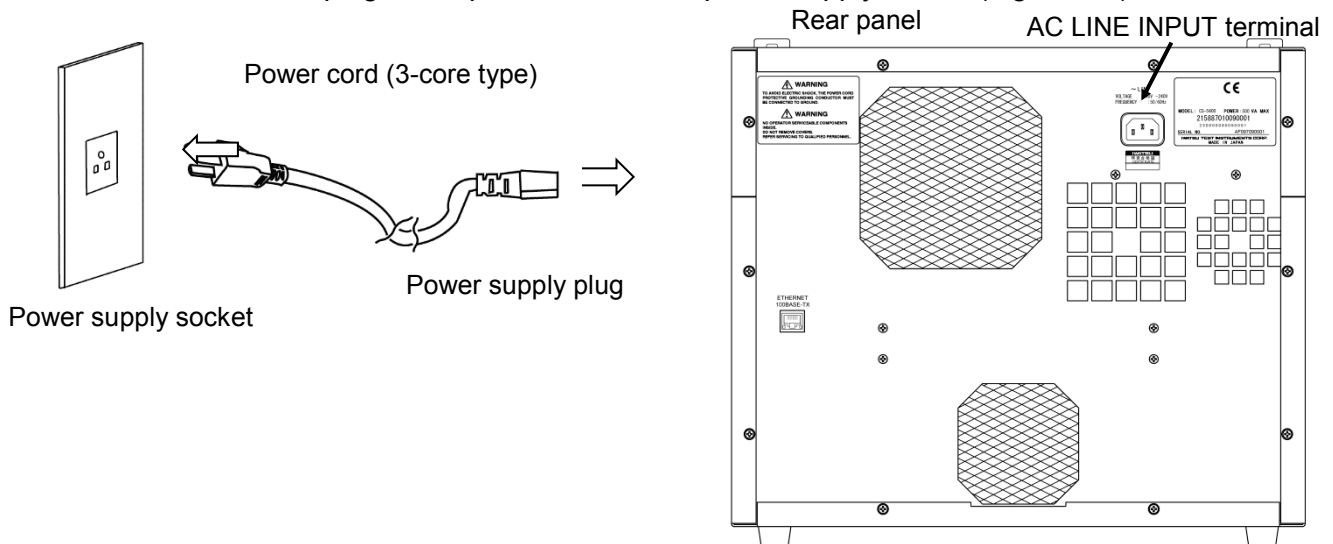

Figure 3.2 Connection of power cord (CS-5200/5300/5400)

Caution!

: The switch with this symbol is ON/Standby switch. Pressing this switch allows this instrument to change between the operation mode and standby mode; i.e., it cannot power this instrument off. Therefore, to shut off the power to this instrument completely, put this instrument in the standby state and then pull the power cord out from the AC socket.

3.3.2 Connecting the test fixture with the main body

The device to be measured is connected to the main body through the test adapter, test fixture, connector box, and the input/output terminal of the main unit.

Connecting the test fixture to the main body

Insert horizontally the connector box into the input/output terminal of the main body so that there is no gap between them.

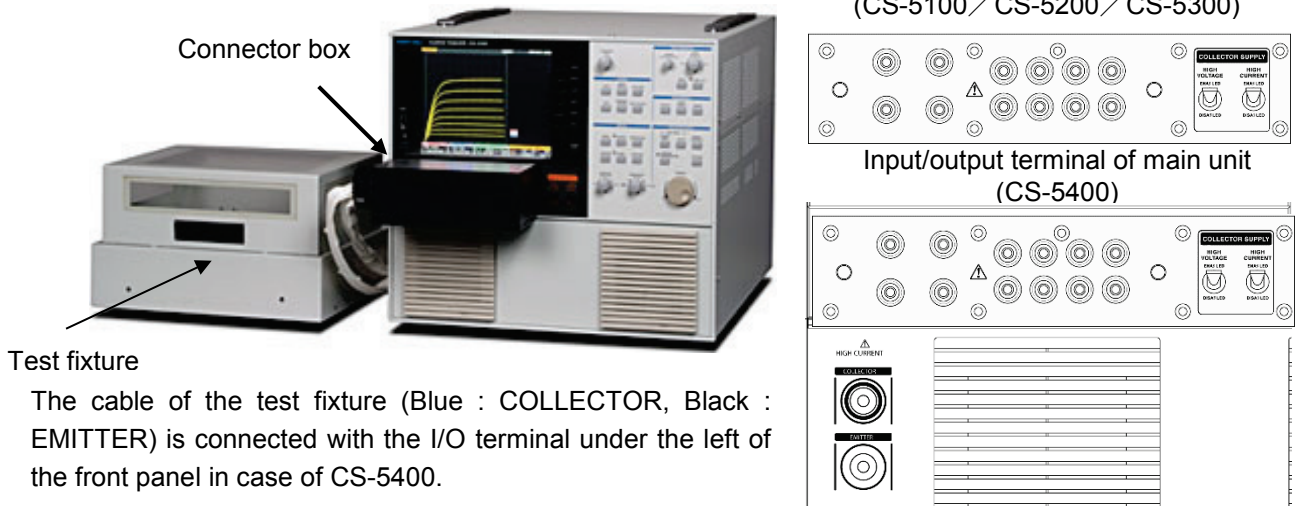

The cable of the test fixture (Blue : COLLECTOR, Black : EMITTER) is connected with the I/O terminal under the left of the front panel in case of CS-5400.

Caution! mark in the front terminal of the main unit shows the following cautions.

- ◆ Please connect and use our test fixture CS-303 and CS-304 for the front terminal part of the main unit.

Powering on and confirming connection

- (1) Press the power on switch on the front panel.
After powering on, the initial setting screen appears. If you want to display with the previous setting when powering on, use SYSTEM SETUP in UTILITY to set POWER ON SETUP to LAST.
- (2) Set HIGH VOLTAGE breaker or HIGH CURRENT breaker to ENABLED.
The output state of the screen is set to ENABLE. If not inserted completely, INTERLOCK will light up.
If the test fixture is not connected or the cover of it opens, this instrument is changed to the state of interlock and its output is shut off.

Caution!

- ◆ If the cover of the test fixture is opened during measurement and then closed for the 2nd measurement, the voltage or current for the 1st measurement is applied to a measured device.
- ◆ The cable of the test fixture (Blue : COLLECTOR, Black : EMITTER) is connected with the I/O terminal under the left of the front panel in case of CS-5400. Even if the cable has come off, the measurement is begun. Moreover, there is an influence possibility in measurements when measuring in the uncertain connected state.

Note: When the breaker is set to ENABLED, the voltage being set by VARIABLE is generated. Before carrying out measurement, confirm the breaker being set to ENABLED.

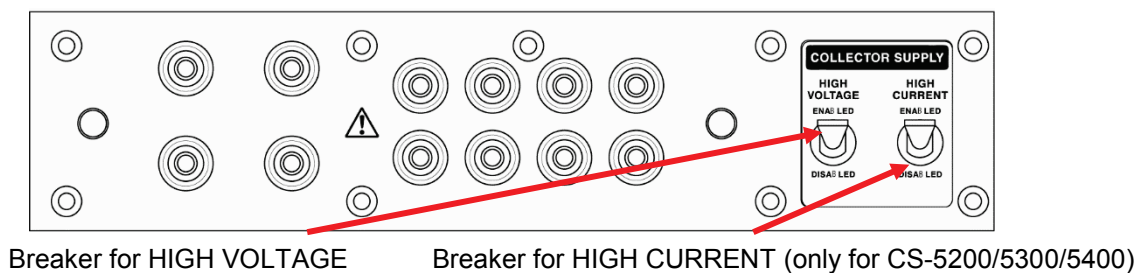

Interlock function

The interlock function is provided in this instrument.

The interlock function is a function to intercept the output when the test fixture is not connected to protect the human body from the high tension output, or when the lid of the test fixture is open.

The state display on the left of the screen of this instrument becomes **INTERLOCK** when entering the state of interlock.

In hardware, the output is compulsorily intercepted, and the Discharge circuit operates, and the electric charge accumulated in the capacity of the device is discharged.

Also software stops SWEEP, and sets the VARIABLE value to 0% internally. Thus, the interlock function operates for double three piles, and secures the safety to the human body.

3.3.3 Connecting the patch panel (for CS-303/CS-304)

Connection of the patch panel uses the attached Test Lead. There are 4 connection methods; HIGH VOLTAGE mode and HIGH CURRENT mode using patch panel, and HIGH VOLTAGE mode and HIGH CURRENT mode using direct connection to a measured device without use of the patch panel, which can be selected depending on your application. The test fixture CS-303 is for main unit CS-5100/CS-5200/CS-5300, and the test fixture CS-304 is for main unit CS-5400.

(1) For HIGH VOLTAGE

Connection of terminals on the test fixture in HIGH VOLTAGE MODE is shown below. If the measured device generates oscillation, it should be connected to BASE/GATE 1KΩ terminal as shown by the dotted line to prevent the oscillation.

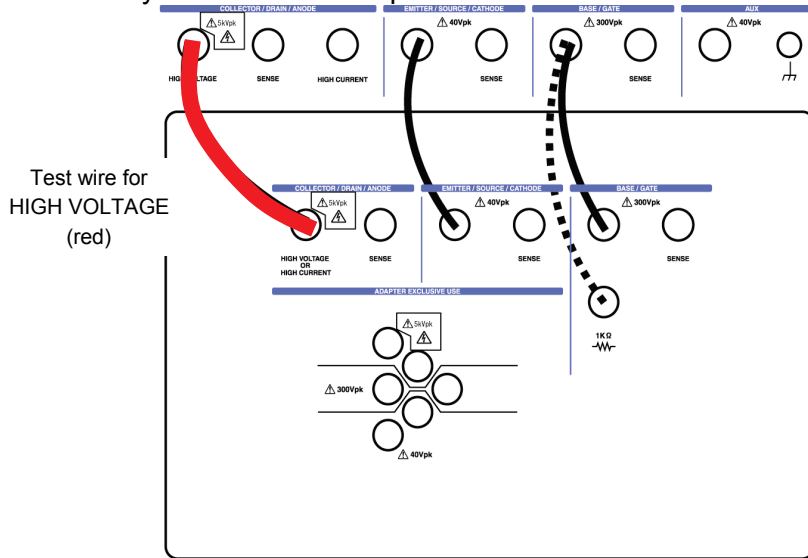

Caution !

At HIGH VOLTAGE MODE, connect Collector terminal using RED color wire which comes with this unit as standard accessory and carefully avoid incorrect wiring.

These connections may cause of damage on DUT and/or malfunction of the unit.

(2) For HIGH CURRENT

When large current is applied to a measured device, connect the device to SENSE terminal and perform Kelvin Sense to achieve the high accuracy measurement. **Be sure to connect to SENSE terminal for measurement with high accuracy.**

If connection to SENSE terminal is not made in HIGH CURRENT mode, no device can be measured. Connect when measuring with test fixture CS-304 in the HIGH CURRENT mode as shown in a lower right picture.

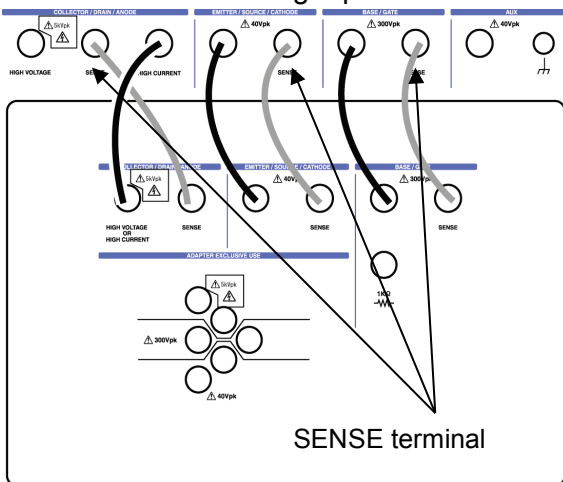

Test fixture CS-303

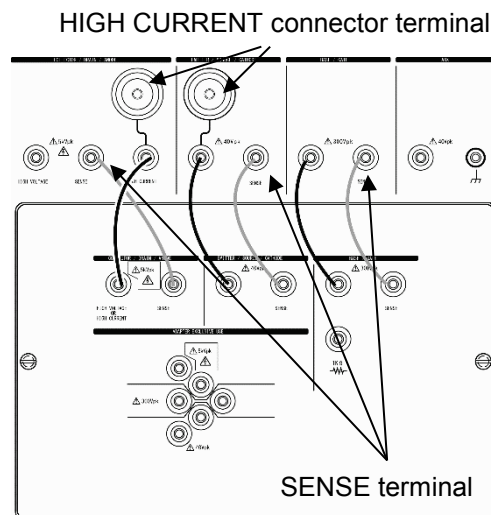

Test fixture CS-304

Memo

Kelvin Sense

Since voltage drop caused by the contact resistance of a contact is not included in measurement, high accuracy measurement can be attained.

(3) Without patch panel in HIGH VOLTAGE

Remove the patch panel and directly connect a measured device through the attached Test Lead.

Remove the patch panel and directly connect a measured device.

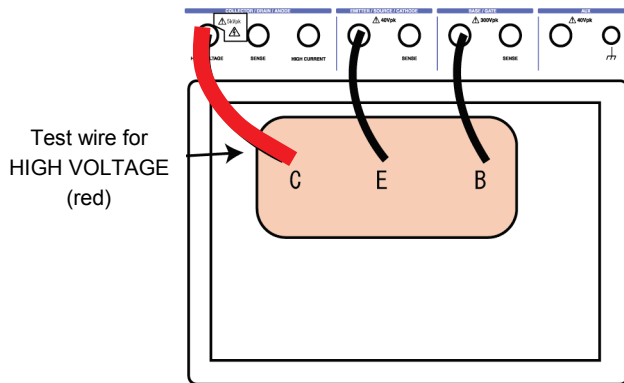

Caution !

At HIGH VOLTAGE MODE, connect Collector terminal using RED color wire which comes with this unit as standard accessory and carefully avoid incorrect wiring.

These connections may cause of damage on DUT and/or malfunction of the unit.

(4) Without patch panel in HIGH CURRENT

Remove the patch panel and directly connect a measure device through the attached Test Lead.

Be sure to connect to SENSE terminal for measurement.

If connection to SENSE terminal is not made in HIGH CURRENT mode, no device can be measured. Connect the terminal COLLECTOR and the terminal EMITTER with the HIGH CURRENT connector terminal in the test fixture CS-304 as shown in a lower right picture when measuring in the HIGH CURRENT mode.

Remove the patch panel and directly connect a measured device.

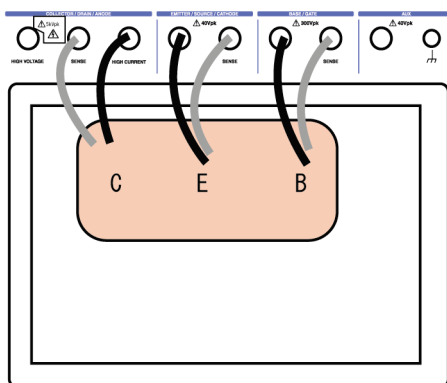

Test fixture CS-303

Remove the patch panel and directly connect a measured device.

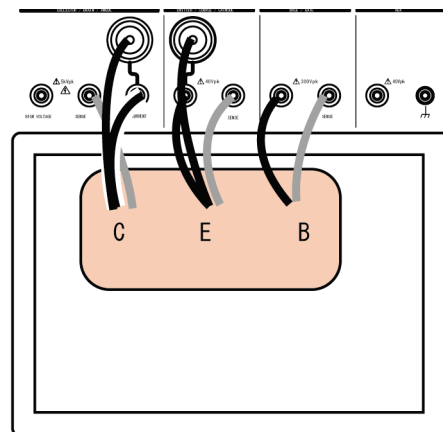

Test fixture CS-304

Caution !

- Very dangerous voltage is applied to the collector and base terminals. Dangerous operation must be avoided; i.e., emitter terminal short-circuited with collector or base terminal.

3.3.4 Connecting the measured device with the test adapter CS-500

[Connection procedure]

- (1) Open the cover of the test fixture.
If the cover is opened, this instrument is changed to INTERLOCK state and its output is shut off.
- (2) Open the cover of the test adapter CS-500.
To open the cover, insert the screwdriver (minus) into the arrow part as shown below (cover of test adapter):

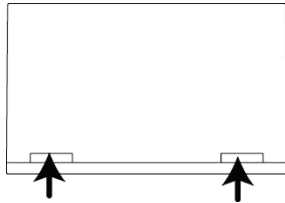

- (3) Connect the test adapter with the measured device.
 - For transistor: Connect the collector, base, and emitter to the collector, base, and emitter of the test adapter.
 - For FET: Connect the drain, gate, and source to the collector, base, and emitter of the test adapter.
 - For diode: Connect the anode and cathode to the collector and emitter of the test adapter.
- (4) Mount the test adapter on the patch panel
When mounting the test adapter, push it into the patch panel vertically in parallel to the patch panel.

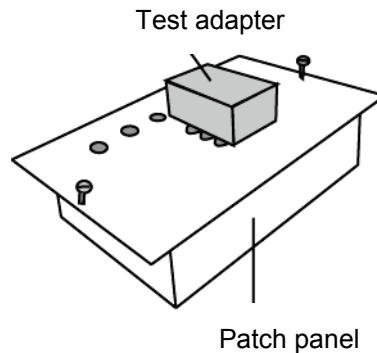

- (5) If the cover of the test fixture is closed after connecting the test adapter, INTERLOCK state is released and measurement can be carried out.

3.3.5 Connecting the measured device with the test adapter CS-501A (Option)

It is not possible to measure at the same time though two kinds of devices to be measured can be installed in this test adaptor CS-501A. Measure by installing one device to be measured and one insulation tab.

[Connection procedure]

(1) Open the cover of the test fixture.

If the cover is opened, this instrument is changed to INTERLOCK state and its output is shut off.

(2) Connect the test adapter CS-501A with the measured device.

1) Select A or B depending on the type of the measured device as shown below:

2) Insert the terminals of the measured device into the connection grooves of the socket. Insert the insulation tab in the socket that becomes empty. (When buying it, the insulation tab is inserted in socket A or B.)

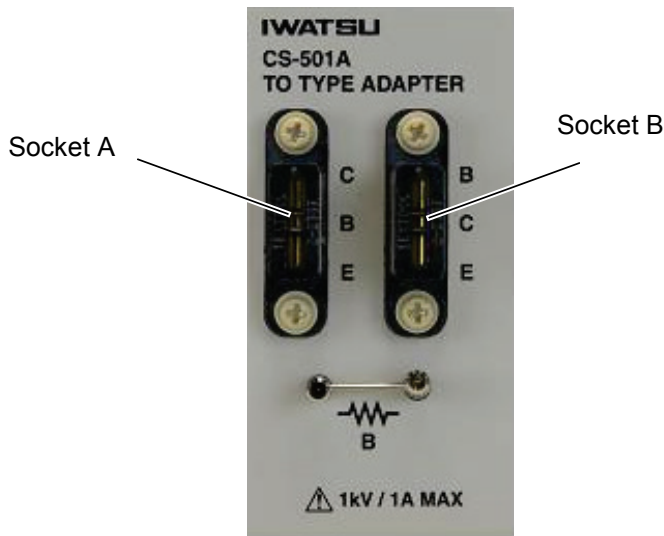

Caution!

Base resistance and insulation tab

The test adapter CS-501A is equipped with the short terminal for the base resistance as an accessory. It can be screwed at both ends of it.

The resistance with a proper constant is installed to the base resistance mainly for protection from oscillation. If an influence by oscillation is made, install the resistor element. If not, surely install the short terminal attached.

In test adaptor CS-501A, insert an accessory insulation tab in socket A or B not to connect the measurement element for an accurate measurement while measuring.

- For transistor: Connect the collector, base, and emitter to the collector, base, and emitter of the test adapter.
- For FET: Connect the drain, gate, and source to the collector, base, and emitter of the test adapter.
- For diode: Connect the anode and cathode to the collector and emitter of the test adapter.

(3) Mount the test adapter on the test fixture.

When mounting the test adapter, push it into the text fixture vertically while keeping its rear surface parallel to the mounting part of the patch panel.

(4) If the cover of the test fixture is closed after connecting the test adapter, INTERLOCK state is released and measurement can be carried out.

3.3.6 Connecting the measured device with the test adapter CS-502 (Option)

[Connection procedure]

- (1) Open the cover of the test fixture.
If the cover is opened, this instrument is changed to INTERLOCK state and its output is shut off.
- (2) Connect the test adapter CS-502 with the measured device.
Insert the terminals of the measured device into the connection grooves of the socket.

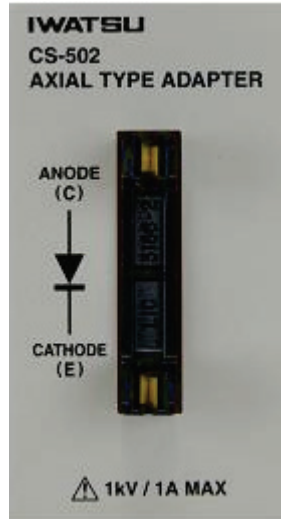

For diode: Connect the anode and cathode to the collector and emitter of the test adapter.

- (3) Mount the test adapter on the test fixture.
- (4) When mounting the test adapter, push it into the test fixture vertically while keeping its rear surface parallel to the mounting part of the patch panel.
- (5) When the cover of the test fixture is closed after connecting the test adapter, INTERLOCK state is released and measurement can be carried out.

3.3.7 Connecting the measured device with the test adapter

CS-503/CS-504/CS-505/CS-506 (Option)

[Connection procedure]

- (1) Open the cover of the test fixture.
If the cover is opened, this instrument is changed to INTERLOCK state and its output is shut off.
- (2) Connect the test adapter CS-503 (or CS-504, CS-505, CS-506) with the measured device.
 - 1) Insert the terminals of the measured device into the connection grooves of the socket.

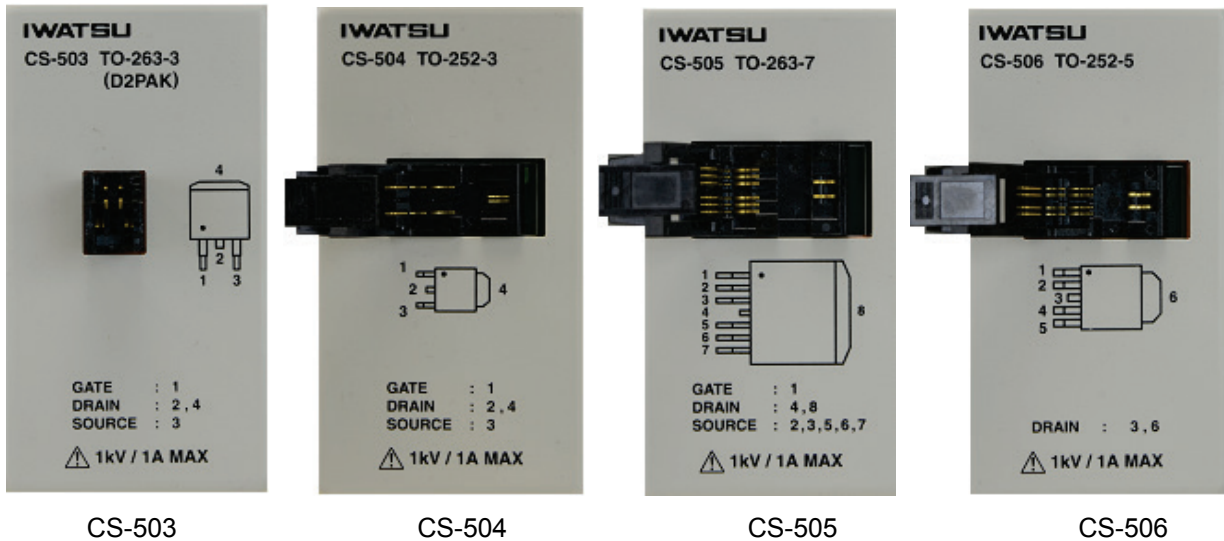

- For CS-503 : Mount the measurement device of following package TO-263-3 (D2PAK) on the socket.

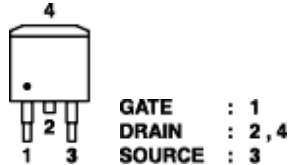

- For CS-504 : Mount the measurement device of following package TO-252-3 on the socket.

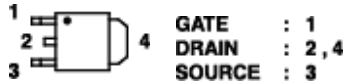

- For CS-505 : Mount the measurement device of following package TO-263-7 on the socket.

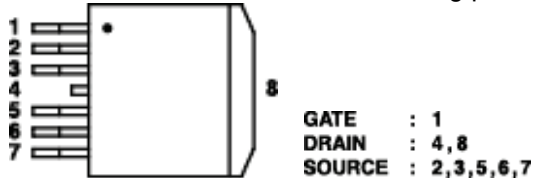

- For CS-506 : Mount the measurement device of following package TO-252-5 on the socket.

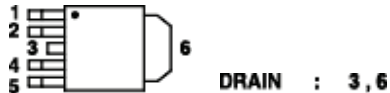

The pin assign of the gate terminal and the source terminal corresponds when the factory is shipped.

- (3) Mount the test adapter on the test fixture.
When mounting the test adapter, push it into the test fixture vertically while keeping its rear surface parallel to the mounting part of the patch panel.
- (4) When the cover of the test fixture is closed after connecting the test adapter, INTERLOCK state is released and measurement can be carried out.

3.3.8 Connecting the measured device with the test adapter CS-507/CS-509 (Option)



It is not possible to measure at the same time though two kinds of devices to be measured can be installed in this adaptor. Measure by installing one device to be measured.

[Connection procedure]

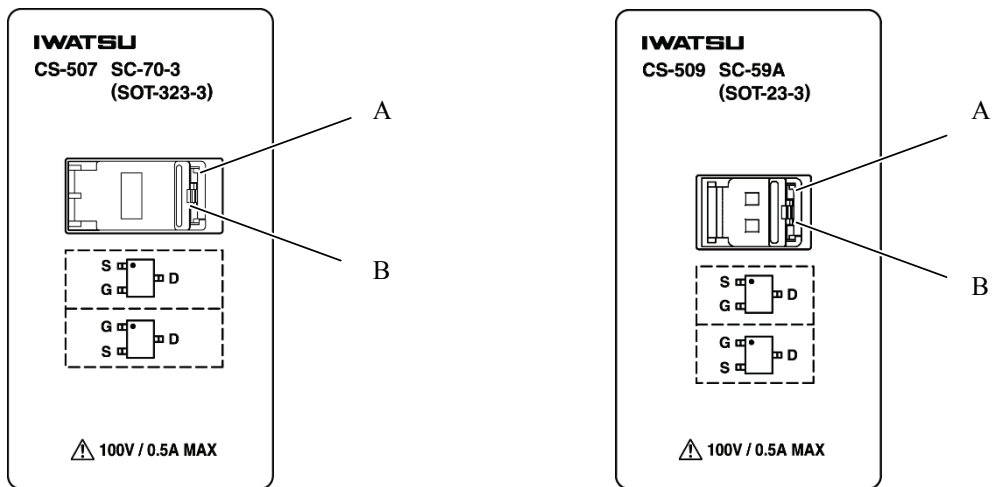
- (1) Open the cover of the test fixture.
If the cover is opened, this instrument is changed to INTERLOCK state and its output is shut off.
- (2) Connect the test adapter CS-507 or CS-509 with the measured device.
 - 1) Select socket A or B depending on the type of the measured device as shown below:
It is not possible to measure at the same time though two kinds of devices to be measured.
 - 2) Mount the measurement device of the package SC-70-3(SOT-323-3) for CS-507, the package SC-59A (SOT-23-3) for CS-509 on the socket.



Mount the measurement device of following the package SC-70-3(SOT-323-3) or the package SC-59A (SOT-23-3) on the socket.

- A in the socket 
- B in the socket 

- (3) Mount the test adapter on the test fixture.
When mounting the test adapter, push it into the text fixture vertically while keeping its rear surface parallel to the mounting part of the patch panel.
- (4) If the cover of the test fixture is closed after connecting the test adapter, INTERLOCK state is released and measurement can be carried out.

3.3.9 Connecting the measured device with the test adapter CS-508 (Option)

[Connection procedure]

- (1) Open the cover of the test fixture.
If the cover is opened, this instrument is changed to INTERLOCK state and its output is shut off.
- (2) Connect the test adapter CS-508 with the measured device.
 - 1) Pull the knob of ②-B to the right, and set the measurement device in ②-A.
 - 2) Loosen a fixed screw of ②-C, pull the knob of ②-C to the left, and expand the applied part of ②-A when you cannot set the measurement device in ②-A only by the knob of ②-B.

Tighten a fixed screw of ②-C and fix when you can attach the measurement device.

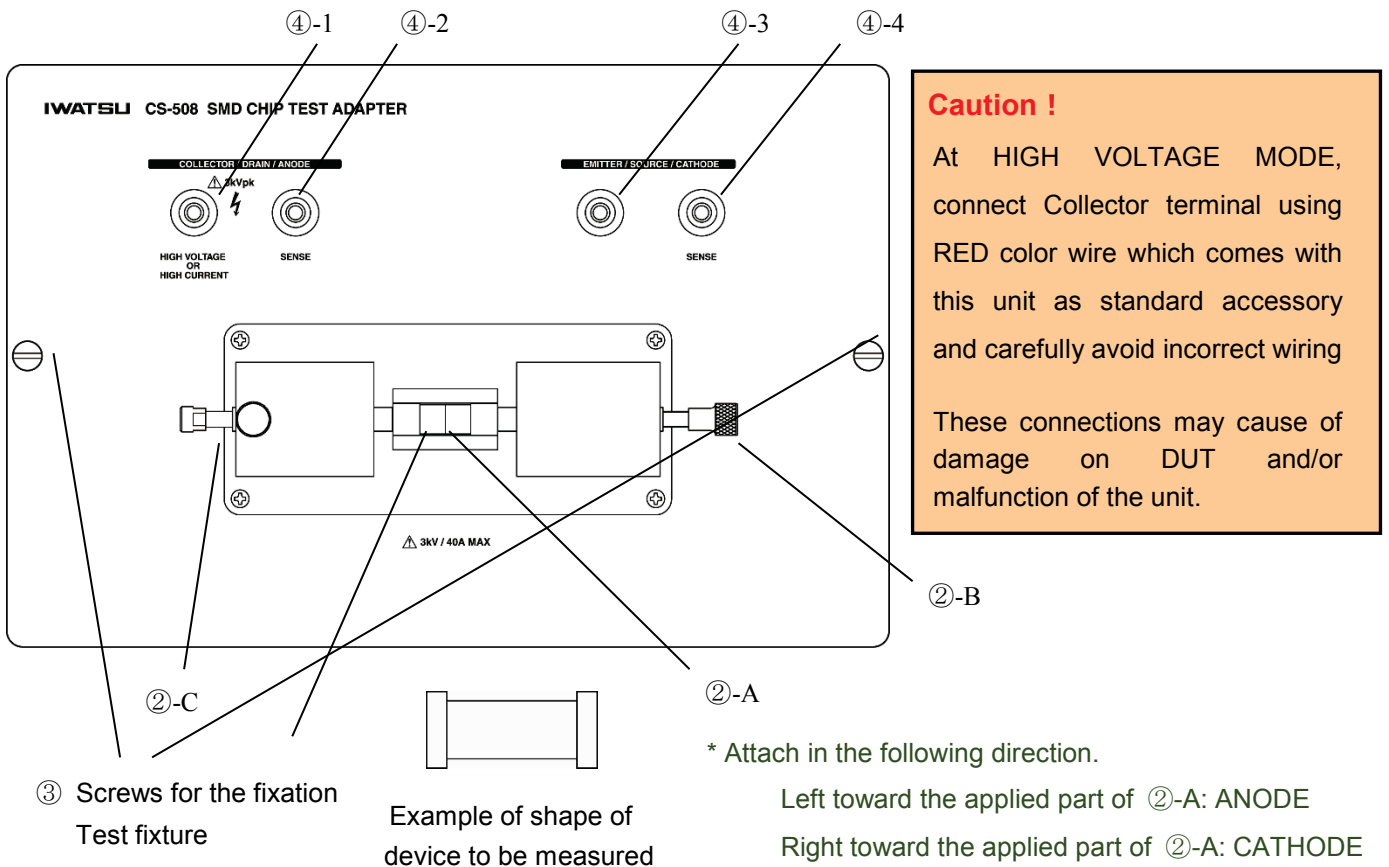

For diode: Connect the anode and cathode to the collector and emitter of the test adapter.

- (3) Mount the test adapter on the test fixture.
- (4) When mounting the test adapter, push it into the text fixture vertically while keeping its rear surface parallel to the mounting part of the patch panel.
- (5) When the cover of the test fixture is closed after connecting the test adapter, INTERLOCK state is released and measurement can be carried out.

3.3.10 Connecting the measured device with the test adapter CS-510 (Option)

[Connection procedure]

- (1) Open the cover of the test fixture.

If the cover is opened, this instrument is changed to INTERLOCK state and its output is shut off.

- (2) Connect the test adapter CS-510 with the measured device.

Insert the terminals of the measured device into the connection grooves of the socket.

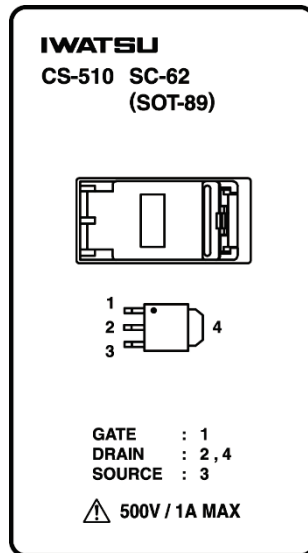

- For CS-510, mount the device to be measured of following package SC-62 type on the socket.



- (3) Mount the test adapter on the test fixture.

When mounting the test adapter, push it into the test fixture vertically while keeping its rear surface parallel to the mounting part of the patch panel.

- (4) When the cover of the test fixture is closed after connecting the test adapter, INTERLOCK state is released and measurement can be carried out.

3.4 Screen structure

The following describes the screen structure displayed on the LCD of this instrument, contents, and references information.

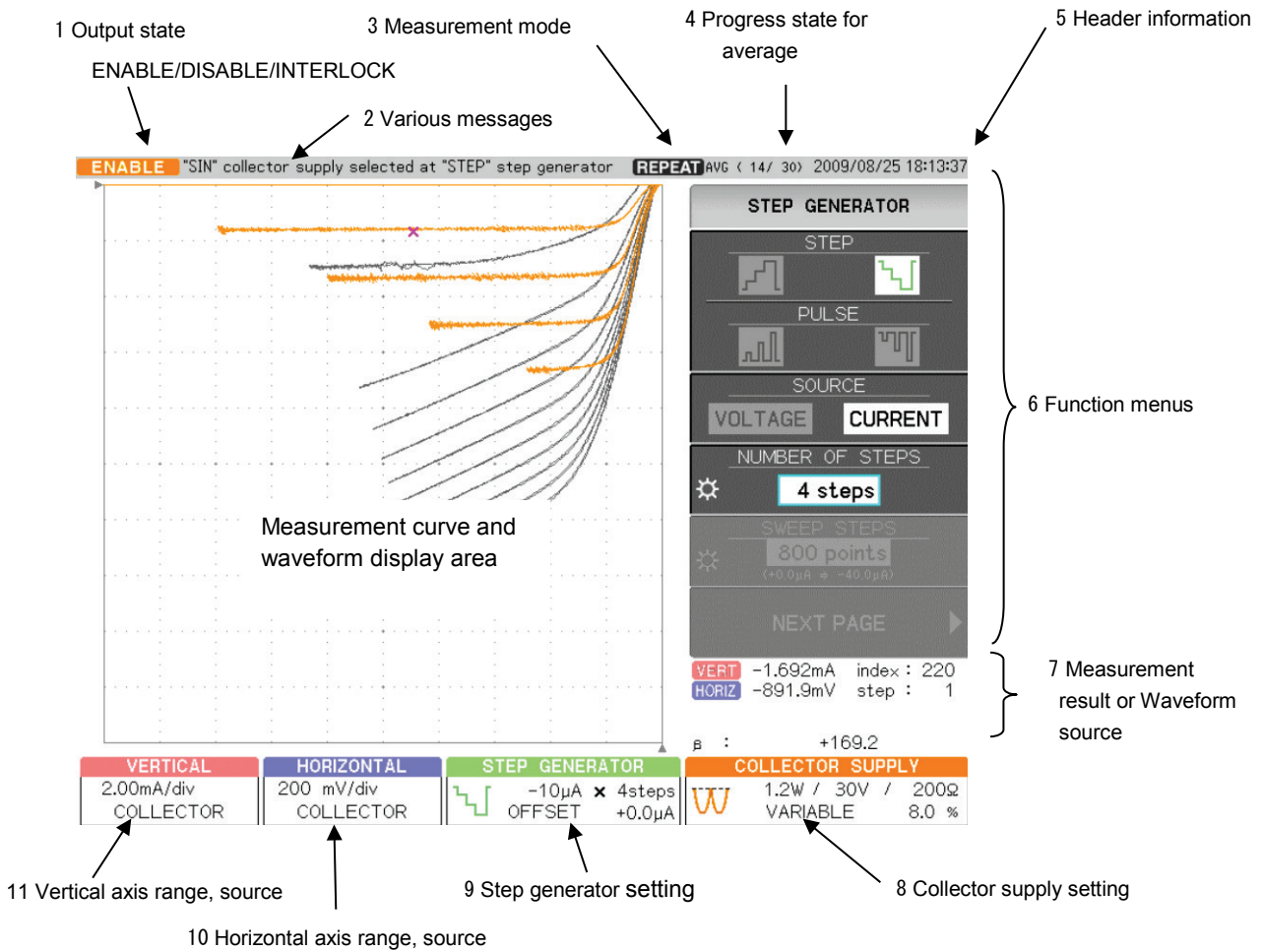



Figure 3.4 Screen structure

Names and displayed contents

NO.	Name	Displayed content	Reference
①	State display	<p>The output state of the collector supply is displayed in 3 statuses below:</p> <p>INTERLOCK: It is displayed when the test box is not connected correctly or the cover of the test fixture is opened.</p> <p>DISABLE: It shows that the collector supply can not output. There are two kinds of breaker switches for COLLECTOR SUPPLY about HIGH VOLTAGE and HIGH CURRENT. When the HIGH VOLTAGE breaker switch is adjusted to the DISABLED side for the HIGH VOLTAGE mode, it is displayed on the left of the screen, "DISABLE". When the HIGH CURRENT breaker switch is adjusted to the DISABLED side for the HIGH CURRENT mode, it is displayed on the left of the screen, "DISABLE".</p> <p>ENABLE: It shows that the collector supply can output. When the lid of test fixture is shut on the ENABLED side, the breaker switch for HIGH VOLTAGE is displayed for the HIGH VOLTAGE mode, "ENABLE". When the lid of test fixture is shut on the ENABLED side, the breaker switch for HIGH CURRENT is displayed for the HIGH CURRENT mode, "ENABLE". ENABLE is set when the breaker switch for COLLECTOR SUPPLY is set to ENABLED and the cover of the test fixture is closed. Even in ENABLE status, when measurement stops (i.e., measurement mode: STOP), the collector supply does not output. The actual status of the collector supply output can be checked by the icons as shown below. Note that in LEAKAGE mode, even when measurement stops, the collector supply continues to output.</p> <p> When COLLECTOR SUPPLY output is ON</p> <p> When COLLECTOR SUPPLY output is OFF.</p>	Section 3.3.2
②	Various messages	Displays execution state of the menu and error messages	—
③	Measurement mode	Displays the measurement mode of REPEAT/SINGLE/STOP/SWEEP	Section 3.8
④	Number of averages	Displays the first progress state. In REPEAT mode, it displays each result after that. The number of averages is 2 to 255.	Section 3.10.1
⑤	Header information	Displays the current time, CONFIGURATION setting, or comment as the header information.	Section 3.11
⑥	Function menus	Pressing a function key (F1 to F6) allows a submenu to appear.	Section 3.5
⑦	Measurement result, or waveform source	Displays the cursor measurement result, the waveform source for WAVE display, and the range settings of vertical and horizontal .	Section 3.10.3 Section 3.10.4
⑧	COLLECTOR SUPPLY	Displays MODE, polarity, VARIABLE, Watt, voltage, and limitation resistance.	Section 3.7
⑨	STEP GENERATOR	Displays MODE, range, number of steps, and offset value.	Section 3.6
⑩	HORIZONTAL	Displays the horizontal axis range and source.	Section 3.9.1
⑪	VERTICAL	Displays the vertical axis range and source.	Section 3.9.2

3.6 Setting step generator

The step generator generates voltage step signals or current step signals to be supplied to the base (gate) of a measured device.

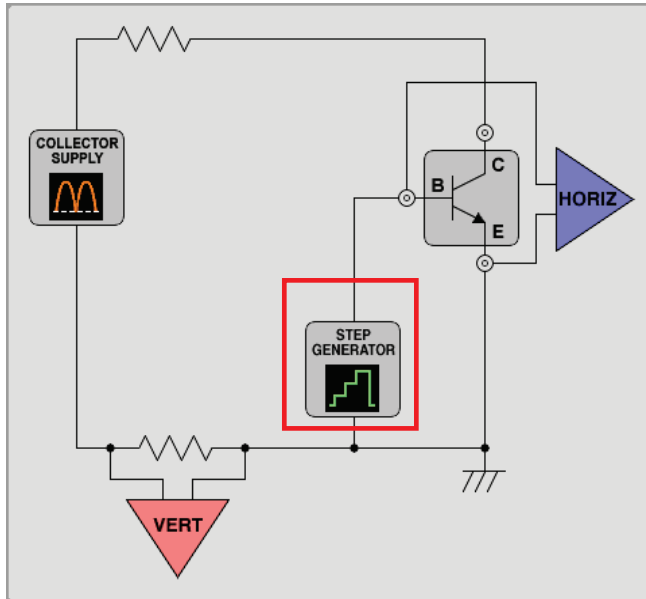

- 3.6.1 Setting STEP knob
- 3.6.2 Setting STEP 1/10 key
- 3.6.3 Setting OFFSET knob
- 3.6.4 Setting MENU key

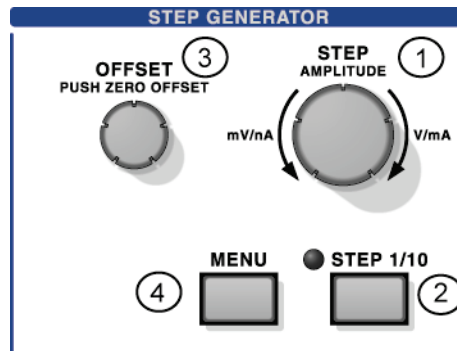

Measurement results are displayed in the setup display area under the waveform display area as shown in the example below:

STEP GENERATOR	
	-1mA × 10steps OFFSET -0.78mA

-1mA	Voltage or current per STEP
10steps	No. of STEPs
	Mode (STEP/PULSE) and polarity (+/-) The left shows the minus polarity of STEP waveform.
-0.78mA	Offset value

3.6.1 Setting STEP knob

3.6.1.1 STEP knob and display menu

Rotating STEP knob ① allows the voltage or current per step to be set.

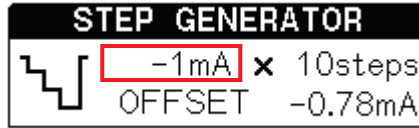
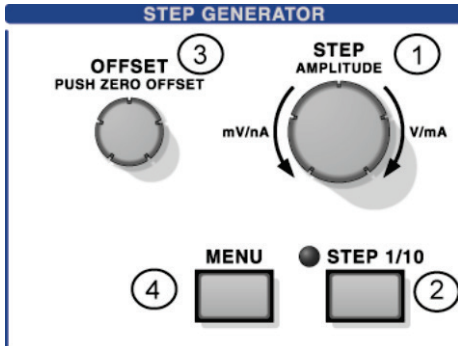

The menu above shows the setting values.

Setting range

When STEP 1/10 key is set to OFF

SOURCE	STEP knob	
	← To left rotation	To right rotation →
VOLTAGE	50mV, 100mV, 200mV, 500mV, 1V, 2V	
CURRENT	50nA, 100nA, 200nA, 500nA, 1μA, 2μA, 5μA, 10μA, 20μA, 50μA, 100μA, 200μA, 500μA, 1mA, 2mA, 5mA, 10mA, 20mA, 50mA, 100mA, 200mA	

3.6.2 Setting STEP 1/10 key

Pressing STEP 1/10 key ② allows 1/10 setting to be set to ON, the LED beside the key to turn on, and 1/10 times of the setting values in the table of Section 3.6.1 to be displayed. Each press of the key changes ON/OFF of 1/10 setting.

STEP 1/10 key setting does not have an effect on the offset setting.

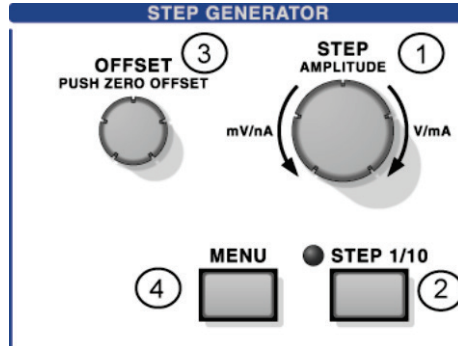

Setting range

When STEP 1/10 key is set to ON

SOURCE	STEP knob	
	← To left rotation	To right rotation →
VOLTAGE	5mV, 10mV, 20mV, 50mV, 100mV, 200mV	
CURRENT	5nA, 10nA, 20nA, 50nA, 100nA, 200nA, 500nA, 1μA, 2μA, 5μA, 10μA, 20μA, 50μA, 100μA, 200μA, 500μA, 1mA, 2mA, 5mA, 10mA, 20mA	

3.6.3 Setting OFFSET knob

3.6.3.1 OFFSET knob and display menu

Rotating OFFSET knob ③ allows the offset voltage or current value of 0 step to be set.

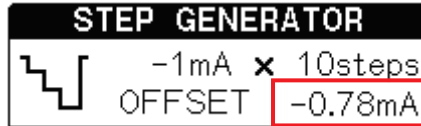
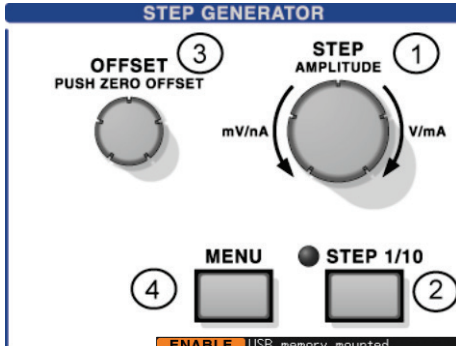

The menu above shows the setting values.

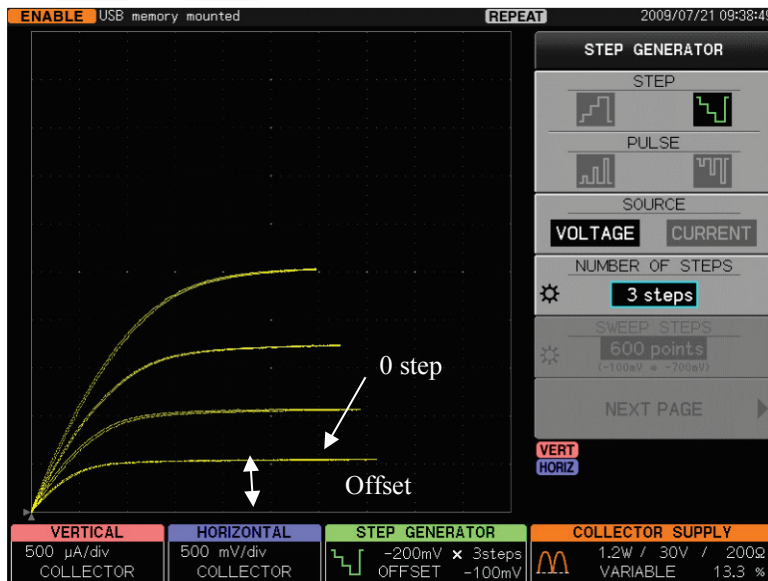

Setting range and functions

- The range from -10 times to +10 times of voltage or current per step of the step generator can be set.
- The offset value changes together with STEP AMPLITUDE 1-2-5 step.
If STEP AMPLITUDE =100mV/div and the offset =100mV, changing STEP AMPLITUDE to 200mV/div or 500mV/div makes the offset values change to 200mV or 500mV too.
- Pressing OFFSET knob allows the setting value to be cleared to 0.
- The resolution is 1% of the voltage or current per step.
- The offset setting is not affected by STEP 1/10 key.

3.6.4 Setting MENU key

3.6.4.1 MENU key and display menu

Pressing MENU key ④ allows the menu "STEP GENERATOR" to appear.

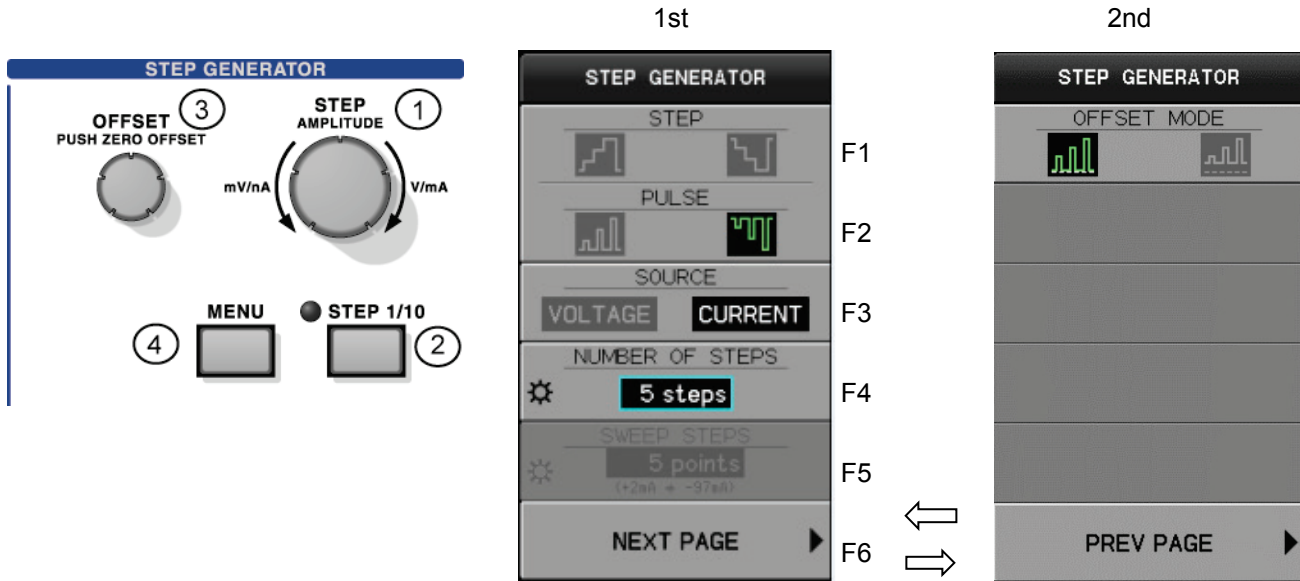

3.6.4.2 Submenus and functions

Setting of 1st menu: STEP and PULSE

	Submenu	Function description: NEXT PAGE - 1st
F1	STEP	Selects +STEP, -STEP, +PULSE, or -PULSE Each press of F1 or F2 key changes the polarities.
F2	PULSE	When the step generator is changed from PULSE to STEP, DC changes to Full-wave. Inversely, when STEP changes to PULSE, Full-wave changes to DC.
F3	SOURCE	Switches the output mode: voltage/current. This switchover allows the step generator to set to the minimum range.
F4	NUMBER OF STEPS	It sets the number of steps (from 0 to 20 steps). If set to 0, the output uses the offset voltage setting value. If the collector supply is set to LEAKAGE, the number is fixed to 0.
F5	SWEEP STEPS	Sets the number of steps for SWEEP measurement. It can be set only when the step generator SWEEP function is available. See Section 3.6.4.4 and Section 3.8.3.
F6	NEXT PAGE	Displays NEXT PAGE – 2nd menu (OFFSET MODE). When +PULSE, -PULSE, +STEP, or -STEP is set, it is available.

Note 1: The measurement frequency per STEP is 50Hz or 60Hz × 2 when the collector supply MODE is set to RECTIFIED SINE (full-wave rectified) and 50Hz or 60Hz when set to AC.



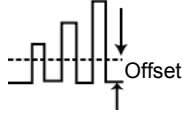
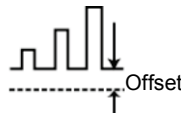

Note 2: When the collector supply is set to HIGH CURRENT, the measurement frequency per step depends on PULSE setting.

2nd menu: How to add the offset in PULSE setting

Submenu		Function description: PREV PAGE - 2nd	
F1	OFFSET MODE	The offset is added to each pulse. 	The offset is added throughout waveforms. 
F6	PREV PAGE	Return to PREV PAGE - 1st menu.	Return to PREV PAGE - 1st menu.

Note: When MODE / POLARITY is in DC mode, difference by OFFSET continues to be output in STOP.

3.6.4.3 Collector supply functions and related items

Collector supply MODE	Step generator	
	STEP	PULSE
AC 	Can be set	Can be set
SINE (full-wave) 	Can be set	When set to PULSE, the collector supply changes to DC.
DC 	When set to STEP, the collector supply changes to SINE (full-wave).	Can be set
LEAK 	Can be set for polarity switchover.	Cannot be set
HC 	Cannot be set	Can be set

Note 1: When the step generator is changed from STEP to PULSE, the collector supply MODE is changed from RECTIFIED SINE (full-wave rectified) to DC.

At the same time when the message area on the screen displays "SIN" collector supply selected at "STEP" at step generator, or "DC" collector supply selected at "PULSE" at step generator, the waveform icons changes on STEP GENERATOR and COLLECTOR SUPPLY menus.

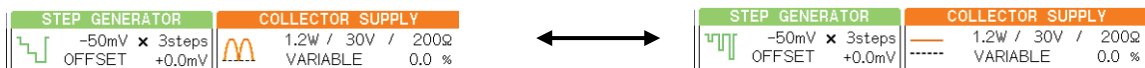

Note 2: HC: HIGH CURRENT mode is not installed in CS-5100 .

3.6.4.4 Step generator SWEEP

The step generator SWEEP is available when the step generator is set to PULSE and HORIZONTAL source is set to BASE-EMITTER (see Section 3.9.1). SWEEP STEPS can be set only when the step generator SWEEP function is available (see Section 3.8.3).

Example of SWEEP STEPS display

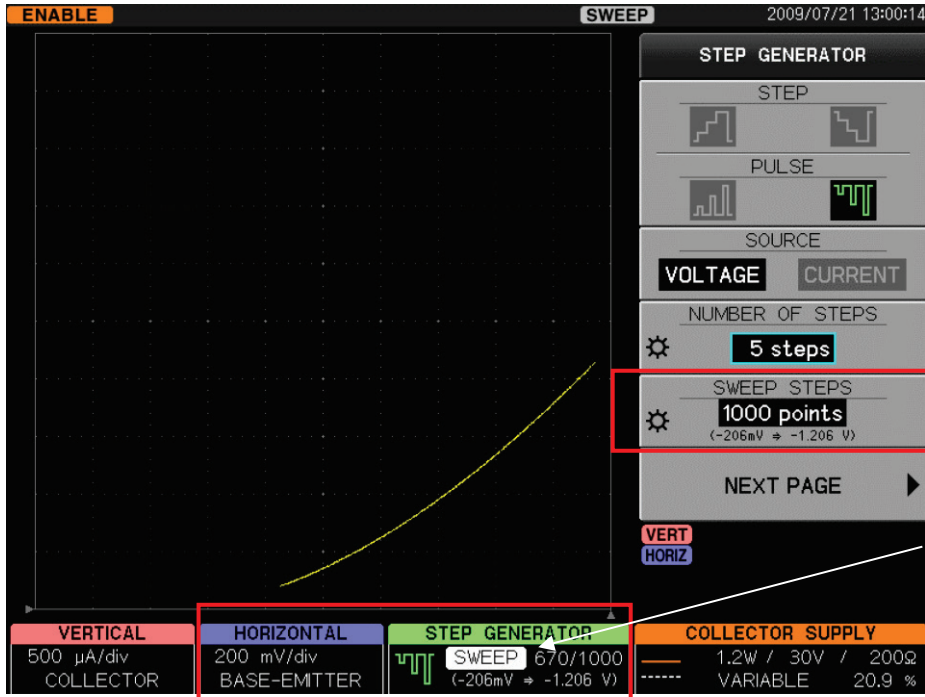

Voltages from (206mV (offset voltage) to 1.206V (200mV (5 (206mV) are swept at 1000 points.

Progress state; e.g., SWEEP 670/1000 is displayed during step generator SWEEP

NUMBER OF STEPS

It sets the number of steps (range: 0 to 20 steps)

SWEEP STEPS setting range

One step of the step generator can be divided into 1 to 200 measurement points using 1-2-5 step (1, 2, 5, 10, 20, 50, 100, 200).

However, the maximum number of measurement points in all steps (SWEEP STEPS setting value) shall not exceed 1000.

Memo
 For example, if NUMBER OF STEPS(6, the number of measurement points can be the minimum of 6 (i.e., 1 point per step) up to the maximum of 600 (i.e., 100 points per step). Since the next of 100 measurement point setting is 200, the total number of points in all steps (6) is 1200. Therefore, the maximum points in this case should be 100.

Starting SWEEP measurement

When the step generator is in PULSE and HORIZONTAL source is in BASE-EMITTER, pressing SWEEP key starts SWEEP measurement.

Operation states are displayed during SWEEP measurement as shown below:

STEP GENERATOR SWEEP 60/150 (-100mV ⇒ +400mV)	SWEEP	Indicates SWEEP measurement being done
	60/150	Current point/ SWEEP STEPS setting value
	-100mV ⇒ +400mV	Value of Step 0 (OFFSET setting value) to value of NUMBER OF STEPS × STEP AMPLITUDE +OFFSET value

Stopping and restarting SWEEP measurement

When the data up to SWEEP STEPS setting value is acquired, the measurement stops and the state returns to STOP. If SWEEP measurement is to be done again, press SWEEP key.

3.7 Setting collector supply

The collector supply generates AC/(SINE) full-wave rectified/DC voltages to be added to the collector (drain/anode) of a measured device.

- 3.7.1 VARIABLE knob
- 3.7.2 MODE/POLARITY key
- 3.7.3 POWER-WATT key
- 3.7.4 VOLTS key
- 3.7.5 ACQUIRE key
- 3.7.6 LOOPING COMPENSATION key

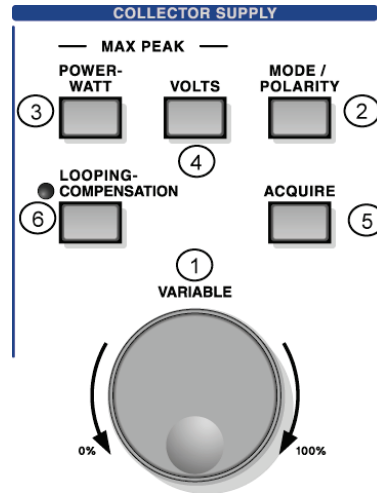

The setting result is displayed in the setup display area under the waveform display area.



120mW	Max. peak power
30V	Max. peak voltage
2KΩ	Inner series resistance value (current limitation resistance)
	Mode and polarity
VARIABLE 0.0 %	Variable value (output level) 0.0% to 100.0%

Current limitation resistance

The current limitation resistance value to limit the peak power applied to a measured device is determined using the maximum peak power and the maximum peak voltage settings as shown below:

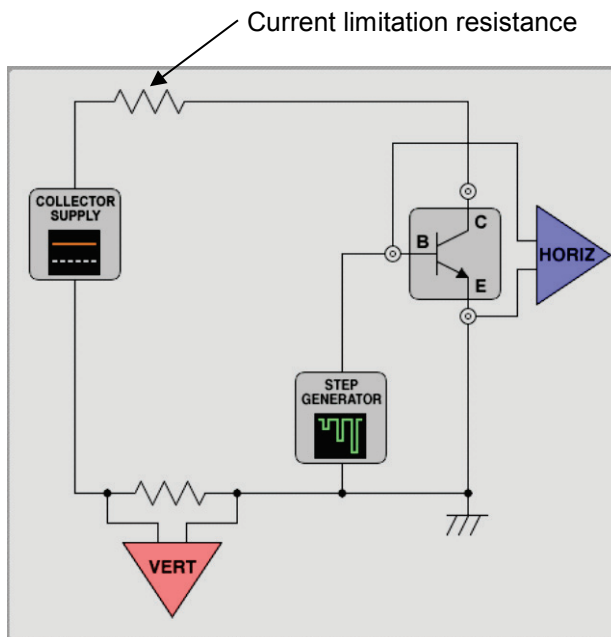

Table 3.7 POWER WATTS/VOLTAGE and current limitation resistance

HIGH VOLTAGE MODE

MAX PEAK POWER WATTS	MAX PEAK VOLTAGE		
	30V	300V	5kV
390W	200mΩ	20Ω	—
120W	2Ω	200Ω	—
12W	20Ω	2kΩ	—
1.2W	200Ω	20kΩ	—
120mW	2kΩ	200kΩ	—
32W	—	—	200kΩ
3.2W	—	—	2MΩ
320 mW	—	—	20MΩ

Attention) "-" in the table cannot be set.

HIGH CURRENT MODE (for only CS-5200/CS-5300/CS-5400)

In case of CS-5200

MAX PEAK POWER WATTS	MAX PEAK VOLTAGE
	40V
4kW (400A)	100mΩ
400W (40A)	1Ω

In case of CS-5300

MAX PEAK POWER WATTS	MAX PEAK VOLTAGE
	40V
10kW (1kA)	40mΩ
4kW (400A)	100mΩ
400W (40A)	1Ω

In case of CS-5400

MAX PEAK POWER WATTS	MAX PEAK VOLTAGE
	30V
12kW (1.5kA)	20mΩ
4.5kW (600A)	50mΩ
450W (60A)	500mΩ

3.7.1 VARIABLE knob

3.7.1.1 VARIABLE knob and display menu

VARIABLE knob sets the output voltage of the collector supply using the ratio to the maximum peak voltage setting value. Rotation of VARIABLE knob allows the collector supply to change from 0% to 100% continuously in 0.1% step. Clockwise rotation increases voltage and counterclockwise rotation decreases it. It is also possible that the VARIABLE knob responds fast. (As for the setting method, refer to 3.11.1.4.2 MEASUREMENT SETUP submenu.)



The setting value is displayed in the setup display area above.

Caution !: When the measurement ends, carry out below:

- ◆ Rotate VARIABLE counterclockwise to set the value to 0 (to reduce the discharge time of an applied voltage).
- (Set HIGH VOLTAGE breaker to "DISABLED."
- (In high voltage output, very small partial discharge may be measured. If it affects the measurement, use the AVERAGE mode.

3.7.1.2 Initializing VARIABLE setting value

The VARIABLE setting value can be initialized to 0% by the operation and conditions below:

- On MODE/POLARITY menu
 - POLARITY is changed.
 - Other switchover than DC ↔ RECTIFIED SINE (full-wave rectified) is done (Ex.: MODE is changed to AC or LEAKAGE.)
 - Switchover of 50Hz ↔ 60Hz is done on ACQUIRE menu.
 - A voltage is changed on MAX PEAK VOLTAGE menu.
 - Switchover between HIGH VOLTAGE and HIGH CURRENT is done.
- Setting is changed on CONFIGURATION menu.
- The breaker used by HIGH VOLTAGE or HIGH CURRENT is set to "DISABLED."
- Overload is detected.

When the range of the vertical axis is too small for the collector current, this instrument changes to the overload state to protect the inner circuits. Either of actions below is done depending on the intensity of a detected current:

 - If the large collector current with steep rise is detected, VARIABLE is reduced to 0%.
 - If the effective current value exceeds a specified value, VARIABLE is reduced below the value.

3.7.2 MODE/POLARITY keys

3.7.2.1 MODE/POLARITY key and display menu

Pressing MODE/POLARITY ② allows "MODE / POLARITY" menu to appear.

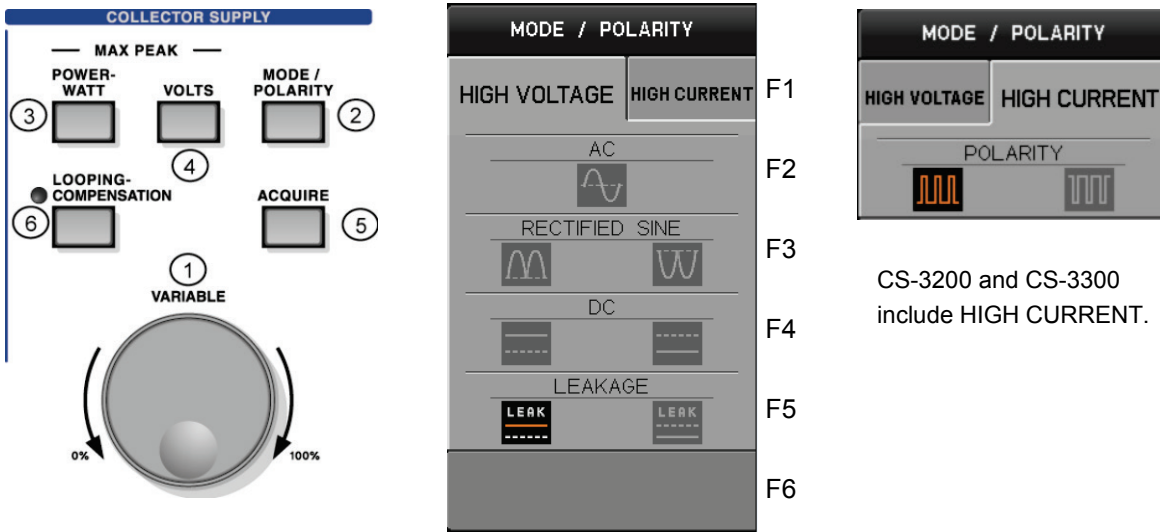

CS-3200 and CS-3300 include HIGH CURRENT.

3.7.2.2 Submenus and functions

Setting of MODE / POLARITY

	Submenus	Function description	Submenu	Function description
F1	HIGH VOLTAGE	High voltage mode	HIGH CURRENT	High current mode
F2	AC	Sine wave	POLARITY	+pulse/-pulse
F3	RECTIFIED SINE	+full-wave rectified/ -full-wave rectified	F3 to F6: (Not used)	
F4	DC	+DC/-DC		
F5	LEAKAGE	+leak/-leak		
F6	(Not used)			

- Select one of F2 to F5.
- In other setting than AC, each press of the function key changes the polarities.
- In switchover between DC and RECTIFIED SINE (full-wave rectified wave), VARIABLE setting value cannot be cleared to 0%; i.e., in other switchover, it can be cleared to 0%. See Section 3.7.1.2 "Initializing VARIABLE setting value."

Trace origin mark ▲ and origin ●

If the horizontal axis is set to COLLECTOR range or BASE-EMITTER range, the origin of the trace display is as follows for setting of AC, +polarity, or -polarity (● position in diagram: origin of trace display):

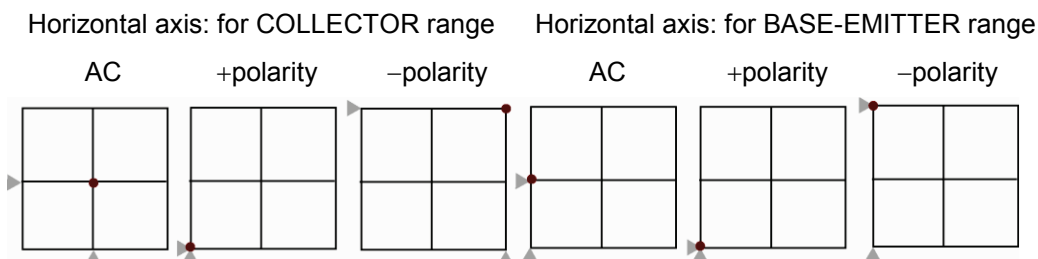





3.7.2.3 Items related to step generator and vertical axis source

The collector supply MODE setting has the relationship with the step generator and the vertical axis source as shown below:

The voltage of the waveform being set is generated to the collector or base.

HIGH VOLTAGE

HIGH VOLTAGE	Step generator STEP/PULSE	Vertical axis source
AC 	Changes to STEP (PULSE is also selectable.)	COLLECTOR: collector current
SINE (full-wave rectified wave) 	Changes to STEP	COLLECTOR: collector current
DC 	Changes to PULSE	COLLECTOR: collector current
LEAKAGE 	Changes to DC No. of steps fixed to 0	EMITTER: emitter current (1000 times of collector current sense)

Example of switchover of the collector supply from RECTIFIED SINE (full-wave rectified wave) to LEAKAGE

Items enclosed by ○ below are changed.

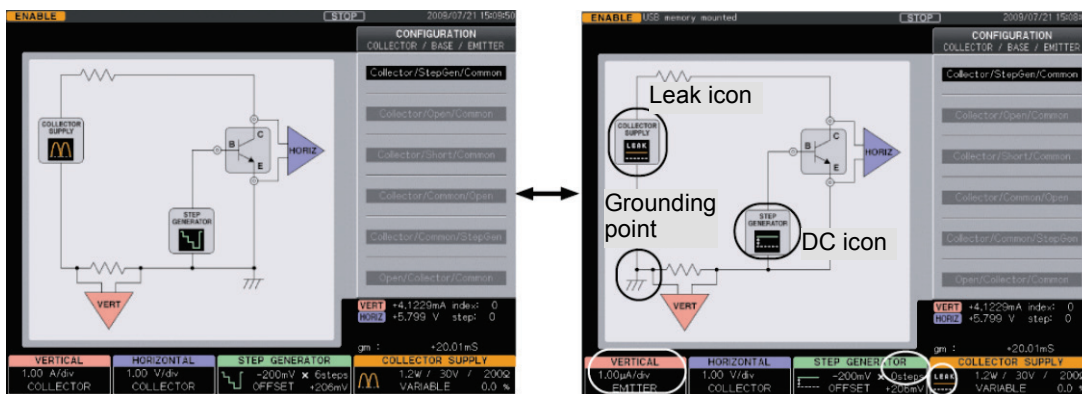

HIGH CURRENT • The HIGH CURRENT mode is not installed in CS-5100.

HIGH CURRENT	STEP/PULSE setting	Vertical axis source display
• HC 	Temporarily changes to PULSE.	COLLECTOR: collector current

Configuration for HIGH CURRENT

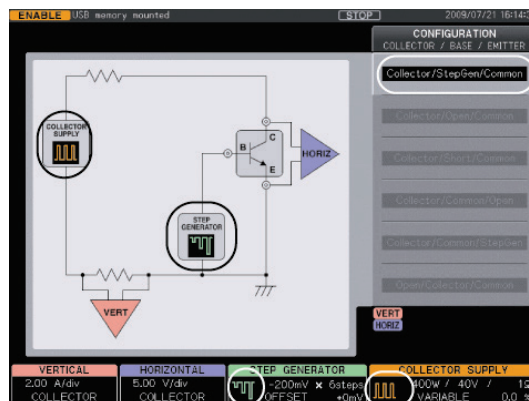

Collector/StepGen/Common fixed

3.7.3 POWER-WATT key

3.7.3.1 POWER-WATT key and display menu

It can limit the maximum peak power to be applied to a measured device; i.e. protecting the device from breakage.

Pressing POWER - WATT key ③ allows "MAX PEAK POWER WATTS" menu to appear.

The diagram shows the 'COLLECTOR SUPPLY' control panel with several keys: POWER-WATT (③), VOLTS (④), MODE / POLARITY (②), LOOPING-COMPENSATION (⑥), and ACQUIRE (⑤). A 'VARIABLE' knob (①) is also shown, ranging from 0% to 100%.

	High Voltage mode	HC(CS-5200 / CS-5300)	HC(CS-5400)	
	MAX PEAK POWER WATTS	MAX PEAK POWER WATTS	MAX PEAK POWER WATTS	
F1	390W	10kW (1kA)	12kW (1.5kA)	
F2	120W	4kW (400A)	4.5kW (600A)	
F3	12W	400W (40A)	450W (60A)	
F4	1.2W			
F5	120mW			
F6				

* 1 The HIGH CURRENT mode is not installed in CS-5100.
 * 2 10kW cannot be set for CS-5200.

3.7.3.2 Submenus and functions

	High Voltage mode	High Current mode
F1	Sets the maximum power to be applied to a measured device - When the maximum peak voltage is 30V, and 300V, one of the power is selected by 390W, 120W, 12W, 1.2W., and 120mW. - When the maximum peak voltage is 5kV, , one of the power is selected by 32W, 3.2W., and 320mW.	Sets the maximum power (current) to be applied to a measured device. Following one is selected by the model. - CS-5200 : 4Kw, 400W - CS-5300 : 10kW, 4kW, 400W - CS-5400 : 12kW, 4.5kW, 450W
F2		
F3		
F4		(Not used)
F5		
F6	(Not used)	

This setting value and the maximum peak voltage setting value determine the value of the current limitation resistance internally connected to the collector output in series. See Table 3.7 POWER WATTS/VOLTAGE and the current limitation resistance in Section 3.7. In addition, if the maximum peak voltage setting is 3 kV, 390 W cannot be selected.

3.7.4 VOLTS key

3.7.4.1 VOLTS key and display menu

Pressing VOLTS key ④ allows "MAX PEAK VOLTAGE" menu to appear.

The diagram shows the COLLECTOR SUPPLY control panel with the following components labeled with circled numbers:

- ① VARIABLE: A rotary knob with a scale from 0% to 100%.
- ② MODE / POLARITY: A button.
- ③ POWER-WATT: A button.
- ④ VOLTS: A button.
- ⑤ ACQUIRE: A button.
- ⑥ LOOPING-COMPENSATION: A button.

The table below shows the MAX PEAK VOLTAGE settings for different modes:

	HV	HC (CS-5200/CS-5300)	HC (CS-5400)	
F1	5kV (32W)	40V	30V	F1
F2	300V (120W)			F2
F3	30V (120W)			F3
F4				F4
F5				F5
F6				F6

* The HIGH CURRENT mode is not installed in CS-5100.

3.7.4.2 Submenus and functions

Key	High Voltage mode	High Current mode
F1	Sets the maximum voltage to be applied to a measured device (5kV, 300V, or 30V).	CS-5200/CS-5300 : 40V fixed
F2		CS-5400 : 30V fixed
F3		F2 to F6: (Not used)
F4 to F6	(Not used)	

If the maximum voltage of 5 kV is selected, "5 kV" on COLLECTOR SUPPLY display menu changes to red.

3.7.4.3 Relationship with other menus

The voltage setting value and the maximum peak power setting value determine the value of the current limitation resistance internally connected to the collector output in series. See Table 3.7 POWER WATTS/VOLTAGE and the current limitation resistance in Section 3.7.

If this setting is changed, VARIABLE setting value is cleared to 0%. See Section 3.7.1.2 "Initializing VARIABLE setting value."

If the maximum peak power is set to 390 W and the configuration is set to "Open/Collector/Common" (i.e.: the collector output is connected to the base), 5 kV cannot be selected.

3.7.5 ACQUIRE key

3.7.5.1 ACQUIRE key and display menu

Pressing ACQUIRE key ⑤ allows "ACQUIRE" menu to appear.

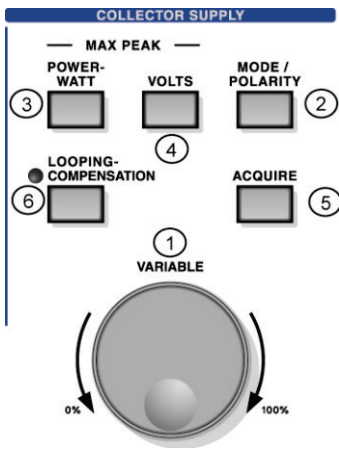

Example of High Voltage mode		Example of High Current mode
<div style="border: 1px solid black; padding: 5px;"> <p style="text-align: center; background-color: #333; color: white; margin: 0;">ACQUIRE</p> <p style="text-align: center; margin: 0;">SINE FREQUENCY</p> <p style="text-align: center; margin: 0;">50 Hz 60 Hz</p> <hr/> <p style="text-align: center; margin: 0;">SWEEP STEPS</p> <p style="text-align: center; margin: 0;">20 points</p> <hr/> <p style="text-align: center; margin: 0;">SWEEP TYPE</p> <p style="text-align: center; margin: 0;">DOWN UP CUSTOM</p> <hr/> <p style="text-align: center; margin: 0;">SWEEP END VARIABLE</p> <p style="text-align: center; margin: 0;">40.0 %</p> <hr/> <p style="text-align: center; margin: 0;">SET CURRENT VARIABLE ↑</p> <hr/> <p style="text-align: center; margin: 0;">SWEEP WAIT TIME</p> <p style="text-align: center; margin: 0;">0.0 sec</p> </div>	<p>F1</p> <p>F2</p> <p>F3</p> <p>F4</p> <p>F5</p> <p>F6</p>	<div style="border: 1px solid black; padding: 5px;"> <p style="text-align: center; background-color: #333; color: white; margin: 0;">ACQUIRE</p> <p style="text-align: center; margin: 0;">PULSE INTERVAL</p> <p style="text-align: center; margin: 0;">80 ms</p> <hr/> <p style="text-align: center; margin: 0;">SWEEP STEPS</p> <p style="text-align: center; margin: 0;">20 points</p> <hr/> <p style="text-align: center; margin: 0;">SWEEP TYPE</p> <p style="text-align: center; margin: 0;">DOWN UP CUSTOM</p> <hr/> <p style="text-align: center; margin: 0;">SWEEP END VARIABLE</p> <p style="text-align: center; margin: 0;">40.0 %</p> <hr/> <p style="text-align: center; margin: 0;">SET CURRENT VARIABLE ↑</p> <hr/> <p style="text-align: center; margin: 0;">SWEEP WAIT TIME</p> <p style="text-align: center; margin: 0;">0.0 sec</p> </div>

*1 The HIGH CURRENT mode is not installed in CS-5100.
 *2 ACQUIRE menu above is used when SWEEP TYPE is CUSTOM.

3.7.5.2 Submenus and functions

High Voltage mode

Key/knob	ACQUIRE	Function description
F1	SINE FREQUENCY	Sets SIN waveform frequency when the collector output is AC or RECTIFIED SINE (full-wave rectified).
F2 FUNCTION	SWEEP STEPS	Available when the step generator is set to PULSE and HORIZONTAL source is set to COLLECTOR. - AC/DC/LEAKAGE: Sets the number of measurement points per step when the collector supply is set to SWEEP. Setting range: 20 to 1000 (increment of 1 STEP) - RECTIFIED SINE (full-wave rectified): not available
F3	SWEEP TYPE	Selects SWEEP direction from DOWN/UP/CUSTOM/DOWN UP. ^{Note} - DOWN: It sweeps the range from VARIABLE setting value when SWEEP starts to 0.0%. - UP: It sweeps the range from 0.0% to VARIABLE setting value when SWEEP starts. - CUSTOM: It sweeps the range from VARIABLE setting value when SWEEP starts to the setting value of SWEEP END VARIABLE. - DOWN UP: ^{Note} Sweep from the VARIABLE set value in point that starts SWEEP to the set value of SWEEP END VARIABLE. In addition, turn as it is continuously, and sweep up to the VARIABLE set value in point that starts SWEEP in the opposite direction.
F4 FUNCTION	SWEEP END VARIABLE	Available only when SWEEP TYPE is CUSTOM/DOWN UP. ^{Note} . It sets VARIABLE setting value to finish or turn SWEEP. Setting range: 0 to 100 % (increment of 0.1 %)
F5 VARIABLE	SET CURRENT VARIABLE	Available only when SWEEP TYPE is CUSTOM/DOWN UP. ^{Note} . Pressing F5 key allows the current VARIABLE setting value to be set to SWEEP END VARIABLE.
F6 FUNCTION	SWEEP WAIT TIME	It can set, in SWEEP operation, the waiting time after a voltage changes in VARIABLE until next data is acquired. (It is available when, e.g., measurement considers the influence of time constant on a measured device.)

Note) When the use of DOUBLE SWEEP optional CS-801 and this function have been turned on, DOWN UP of SWEEP TYPE can be selected. Refer to section 3.11.7 for details of this option CS-801.

High Current mode (This mode is not installed in CS-5100.)

Key/knob	ACQUIRE	Function description
F1 FUNCTION	PULSE INTERVAL	Sets the interval of collector output pulse. The possible ranges to be set depend on the maximum peak power setting (as shown in table below).
F2 FUNCTION	SWEEP STEPS	Available when HORIZONTAL source is COLLECTOR. It sets the number of measurement points per step at the time of collector supply SWEEP Setting range: 20 to 1000 (increment of 1 STEP)
F3	SWEEP TYPE	Selects SWEEP direction from DOWN/UP/CUSTOM/DOWN UP. ^{Note} . - DOWN: It sweeps the range from VARIABLE setting value when SWEEP starts to 0.0%. - UP: It sweeps the range from 0.0% to VARIABLE setting value when SWEEP starts. - CUSTOM: It sweeps the range from VARIABLE setting value when SWEEP starts to the setting value of SWEEP END VARIABLE. - DOWN UP: ^{Note} Sweep from the VARIABLE set value in point that starts SWEEP to the set value of SWEEP END VARIABLE. In addition, turn as it is continuously, and sweep up to the VARIABLE set value in point that starts SWEEP in the opposite direction.
F4 FUNCTION	SWEEP END VARIABLE	Available only when SWEEP TYPE is CUSTOM/DOWN UP. ^{Note} . It sets VARIABLE setting value to finish or turn SWEEP. Setting range: 0 to 100% (increment of 0.1 %)
F5	SET CURRENT VARIABLE	Available only when SWEEP TYPE is CUSTOM/DOWN UP. ^{Note} . Pressing F5 key allows the current VARIABLE setting value to be set to SWEEP END VARIABLE.
F6 FUNCTION	SWEEP WAIT TIME	It can set, in SWEEP operation, the waiting time after a voltage changes in VARIABLE until next data is acquired. (It is available when, e.g., measurement considers the influence of time constant on a measured device.)

Note) When the use of DOUBLE SWEEP optional CS-801 and this function have been turned on, DOWN UP of SWEEP TYPE can be selected. Refer to section 3.11.7 for details of this option CS-801.

Ranges for PULSE INTERVAL setting in HIGH CURRENT mode are as follows by the model depending on the maximum peak power setting. In both of REPEAT measurement and SWEEP measurement, pulses are generated with this cycle for measurement.

CS-5200

Maximum peak power settings	PULSE INTERVAL range settings
4kW	160ms~1000ms
400W	80ms~1000ms

CS-5300

Maximum peak power settings	PULSE INTERVAL range settings
10kW	320ms~1000ms
4kW	160ms~1000ms
400W	80ms~1000ms

CS-5400

Maximum peak power settings	PULSE INTERVAL range settings
12kW	400ms~1000ms
4.5kW	200ms~1000ms
450W	100ms~1000ms

Conditions for collector supply SWEEP

- The collector supply SWEEP function in HIGH VOLTAGE mode is available if the step generator is set to PULSE and HORIZONTAL source is set to COLLECTOR.
- SWEEP function in HIGH CURRENT mode is available if HORIZONTAL source is set to COLLECTOR.

SWEEP STEPS

- The setting range of SWEEP STEPS is from 20 to 1000. However, the actual number of measurement points uses the smaller number between SWEEP STEPS setting value and 10 times of VARIABLE setting value.

For example, if SWEEP STEPS = 500 and VARIABLE setting = 45.2%, the number of SWEEP measurement points should be 452.

- This is because division by the minimum resolution (0.1%) or more of VARIABLE cannot be made. However, generally the range from VARIABLE setting value up to 0% is divided by the number of SWEEP STEPS when being measured.

Starting SWEEP measurement

- When the collector supply SWEEP is available, pressing SWEEP key allows the collector supply SWEEP measurement to start.

During the collector supply SWEEP, the state is displayed as shown below:

COLLECTOR SUPPLY	SWEEP	During collector supply SWEEP
----- 1.2W / 30V / 200Ω ----- SWEEP 3.2 %	3.2%	Current VARIABLE value

It ends the measurement when you acquire data within the range of VARIABLE corresponding to the setting of SWEEP TYPE. "Sweep completed" is temporarily displayed on the left of the screen, and it enters the state of STOP.

Stopping and restarting SWEEP measurement

Push REPEAT key or STOP key to stop SWEEP.

When SWEEP is completed, VARIABLE setting value returns to the value when SWEEP starts.

Push SWEEP key after setting an appropriate VARIABLE value again when restarting.

3.7.6 LOOPING COMPENSATION key

Pressing LOOPING-COMPENSATION key ⑥ allows "LOOPING COMPENSATION" menu to appear.

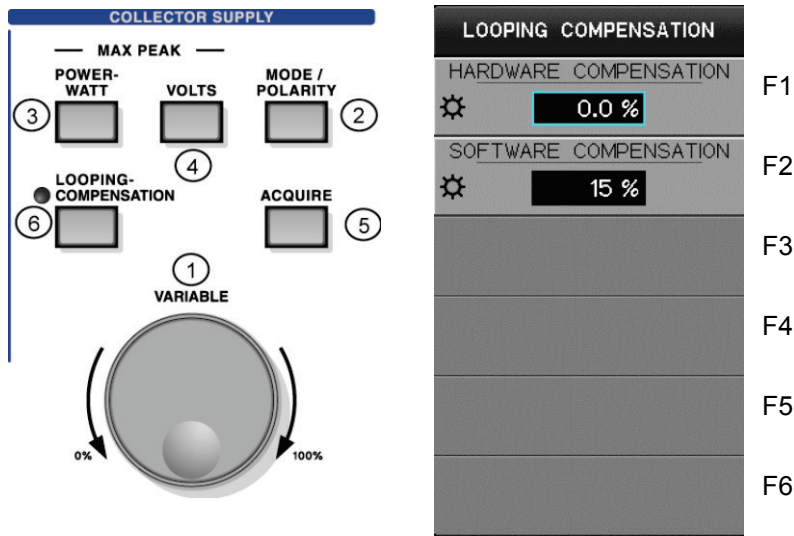

3.7.6.1 Submenus and functions

Rotation of FUNCTION knob allows compensation values and percentage to be set.

Key/knob	Submenus	Function description
F1 FUNCTION	HARDWARE COMPENSATION	Compensates the floating capacity between the collector supply and ground. Setting range: -100.0% to +100.0%, resolution: 0.2%
F2 FUNCTION	SOFTWARE COMPENSATION	Using software thinning, pseudo-compensates the loop. Setting range: 0% to 100% Compensation cannot be done at 0%. In the settings other than 0%, LED beside the key lights up.
F3 to F6	(Not used)	

3.8 Setting measurement

There are three measurement modes: REPEAT, SINGLE, and SWEEP. The upper part on the screen shows the current measurement mode.

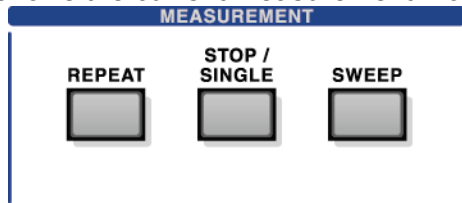

3.8.1 REPEAT

Pressing REPEAT key allows this instrument to change to REPEAT mode; i.e., signals are generated from the step generator at the specified interval and measurement is repeated.

3.8.2 SINGLE

Pressing STOP/SINGLE key allows this instrument to change to SINGLE mode; i.e., the signal with the set number of steps is generated from the step generator once and measurement is done. When the measurement ends, this instrument changes to STOP state. In addition, use of this key allows REPEAT measurement and SWEEP measurement to end and this instrument to change to STOP state.

In STOP state, output and measurement with the step generator stop. For collector supply output, the output stops at the time of AC, SINE (full-wave rectified), or DC. The collector supply in LEAKAGE always generates the setting voltage.

3.8.3 SWEEP

Conditions for collector supply SWEEP

The collector supply SWEEP function is available if the step generator is set to PULSE and HORIZONTAL source is set to COLLECTOR. In this case, selection of SWEEP TYPE from DOWN/UP/CUSTOM/DOWN UP ^{Note} allows operations as shown below:

- DOWN: It sweeps the range from VARIABLE setting value when SWEEP starts to 0.0%.
- UP: It sweeps the range from 0.0% to VARIABLE setting value when SWEEP starts.
- CUSTOM: It sweeps the range from VARIABLE setting value when SWEEP starts to the setting value of SWEEP END VARIABLE.
- DOWN UP ^{Note}: Sweep from the VARIABLE set value in point that starts SWEEP to the set value of SWEEP END VARIABLE. In addition, turn as it is continuously, and sweep up to the VARIABLE set value in point that starts SWEEP in the opposite direction.

In any case above, after SWEEP measurement ends, VARIABLE setting value returns to the value when SWEEP starts.

Note) When the use of DOUBLE SWEEP optional CS-801 and this function have been turned on, DOWN UP of SWEEP TYPE can be selected. Refer to section 3.11.7 for details of this option CS-801.

Conditions for step generator SWEEP

If the step generator is set to PULSE and HORIZONTAL source is set to BASE-EMITTER, the step generator SWEEP is available. In this case, the range from the offset voltage up to the maximum value of the step signal (voltage per step × number of steps + offset voltage) is automatically swept using the set number of steps for measurement.

SWEEP start

When SWEEP is available, pressing SWEEP key allows SWEEP to start.

3.8.3.1 Information on SWEEP measurement

As the voltage increases by applying DC voltage for the collector supply or applying the pulse voltage for the step generator to the collector or base, the spot moves but no trace remains. SWEEP measurement displays the movement of this spot using continuous dots.

Functions related to SWEEP measurement are as follows:

Step generator SWEEP

- Section 3.6.4.4: Setting MENU key of the step generator
It describes the step generator SWEEP measurement and action which applies the pulse voltage to the base.
- Section 4.1.3.3: I_D vs. V_{GS} characteristics and forward direction transfer admittance
It shows the measurement example of the step generator SWEEP.

Collector supply SWEEP

- Section 3.7.5: ACQUIRE key
It describes functions and actions of the collector supply ACQUIRE key.
SWEEP setting: It describes how to set the number of steps (number of measurement points) of the collector supply SWEEP.
- Section 4.1.1.3: Measuring the reverse characteristics (breakdown) of diode
It shows the measurement example of the collector supply SWEEP.
- Section 4.2.1: Measuring IGBT characteristics
It shows the measurement example of the collector supply SWEEP.

3.9 Setting with HORIZONTAL knob/ VERTICAL knob

For TRACE screen

The HORIZONTAL knob is used to set the range of the horizontal axis (VOLTS/DIV) and sources of COLLECTOR, BASE-EMITTER, and STEP. The VERTICAL knob is used to set the range of the vertical axis (CURRENT/DIV) and sources of COLLECTOR and STEP.

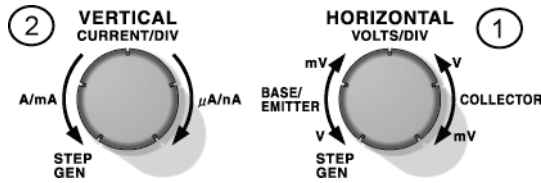

The setting result is displayed in the setup display area under the waveform display area.

VERTICAL	HORIZONTAL	STEP GENERATOR	COLLECTOR SUPPLY
200 mA/div	500 mV/div	-200 μ A x 12steps	120mW / 30V / 2k Ω
COLLECTOR	BASE-EMITTER	OFFSET +0 μ A	VARIABLE 0.0 %

For WAVE screen

For WAVE screen, actions of the vertical axis range and the horizontal axis range are as follows:

- For the vertical axis range, the source always moves together in other case than STEP.
- For the horizontal axis range, the waveform moving together changes (Vbe/Vce) depending on the source of COLLECTOR or BASE-EMITTER.

For example, if the source of the horizontal axis range is set to COLLECTOR and "Ic" is selected for the 1st waveform on VIEW MODE = WAVE screen, the vertical range and that of the waveform on the 1st side of WAVE move together.

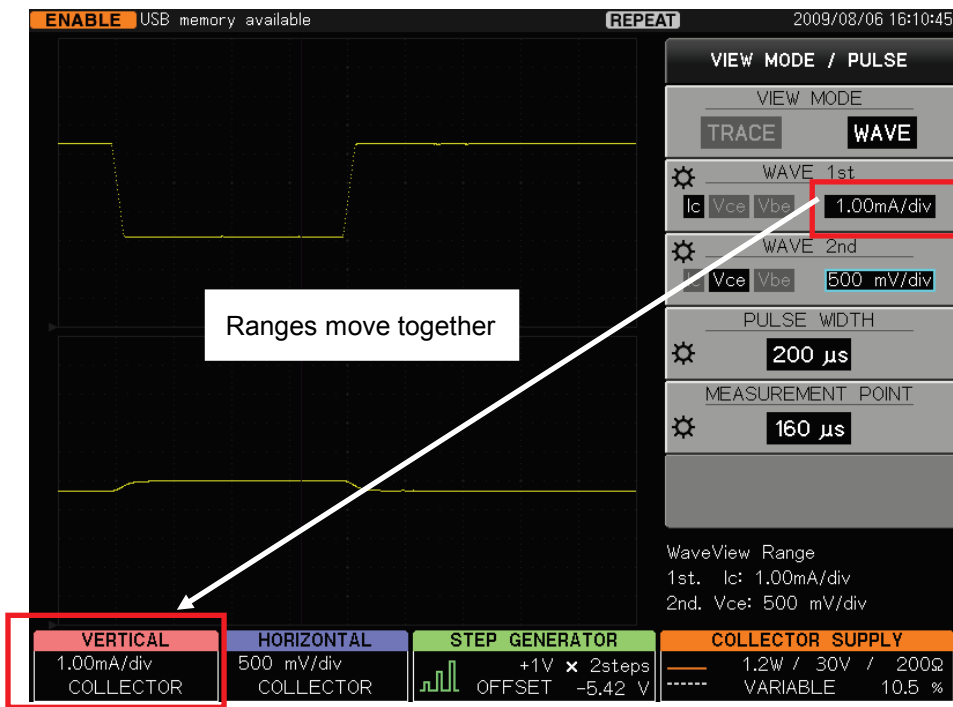

3.9.1 HORIZONTAL knob

Rotating HORIZONTAL knob ① on the previous page allows the sense and source of the horizontal axis to be selected.

The setting result is displayed in the setup display area under the waveform display area.

HORIZONTAL 200 mV/div COLLECTOR	200 mV	Horizontal axis range
	COLLECTOR	Source

Setting range

HORIZONTAL	← To left rotation		To right rotation→	
Source	STEP	BASE-EMITTER	COLLECTOR	
Range	Fixed position display	5.00V/div to 50.0mV/div (1-2-5 step)	HIGH VOLTAGE	500V/div to 50.0mV/div (1-2-5 step) When MAX PEAK VOLTS is 5kV, 500V/div to 500mV/div
			HIGH CURRENT	5.00V/div to 50.0mV/div (1-2-5 step)

* The HIGH CURRENT mode is not installed in CS-5100.

Source: STEP

If HORIZONTAL knob is turned fully counterclockwise, this instrument changes to STEP display and the horizontal axis is fixed; i.e., it is not connected to the horizontal amplifier and 1 step of the step generator is indicated by 0.5div.

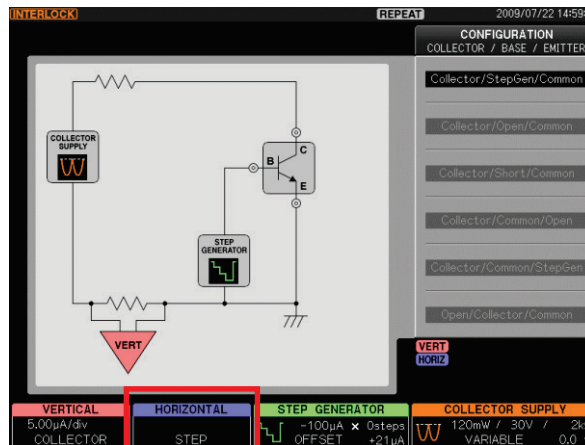

Source: COLLECTOR

If other than Open/Collector/Common is selected on CONFIGURATION menu, the voltage between collector and emitter (V_{ce}) is displayed. If Open/Collector/Common is selected, the voltage between base and emitter (V_{be}) is displayed when the source is COLLECTOR.

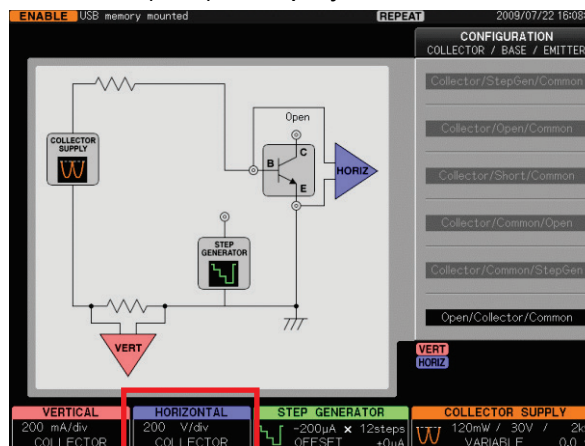

Source: BASE-EMITTER

If Collector/ StepGen/Common is set on CONFIGURATION menu, Vbe voltage is measured.

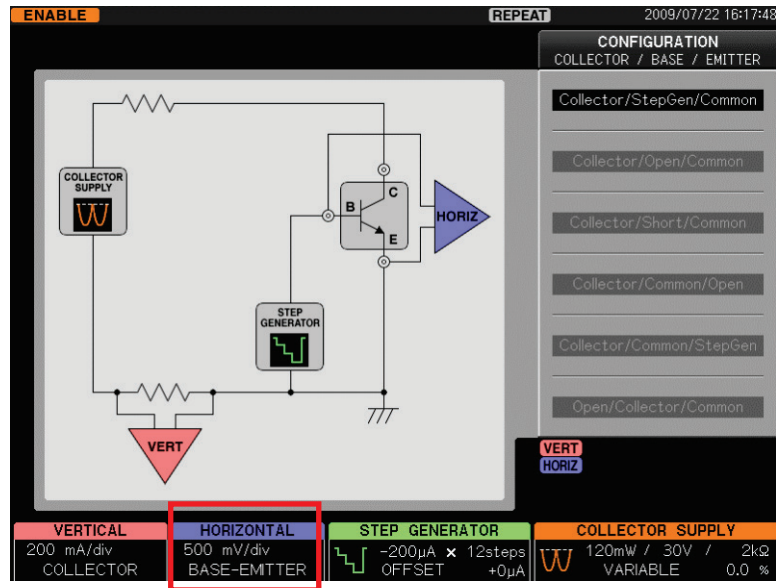

If Collector/ Common/StepGen is set on CONFIGURATION menu, Veb voltage is measured.

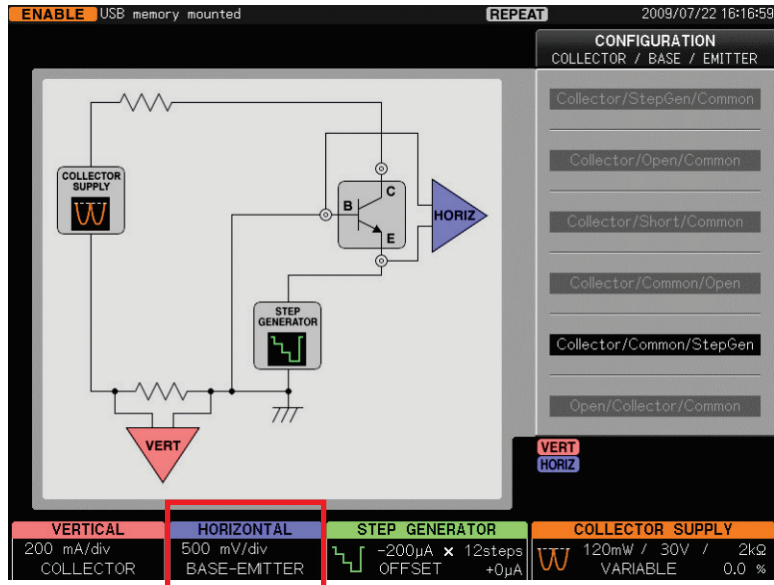

3.9.2 VERTICAL knob

Rotating VERTICAL knob allows the sense and source of the vertical axis to be selected. The setting result is displayed in the setup display area under the waveform display area.



50.0 mA	Vertical axis range
COLLECTOR	Source

Setting range

Setting ranges in HIGH CURRENT mode depend on models and the maximum peak power setting.

VERTICAL	← To left rotation		To right rotation→
Source	STEP	COLLECTOR	
Range	Fixed position display	HIGH VOLTAGE: (Each model commonness)	2.00A/div to 1.00uA/div 1-2-5 step
		HIGH CURRENT: CS-5200	4kW(400A) : 50.0A/div to 1.00A/div, 1-2-5 step 400W(40A) : 50.0A/div to 100mA/div, 1-2-5 step
		HIGH CURRENT: CS-5300	10kW(1kA) : 100A/div to 10.0A/div 1-2-5 step 4kW(400A) : 100A/div to 1.00A/div 1-2-5 step 400W(40A) : 100A/div to 100mA/div 1-2-5 step
		HIGH CURRENT: CS-5400	12kW(1kA) : 200A/div to 10.0A/div 1-2-5 step 4.5kW(600A): 200A/div to 1.00A/div 1-2-5 step 450W(60A) : 200A/div to 100mA/div 1-2-5 step

*The HIGH CURRENT mode is not installed in CS-5100.

Source: COLLECTOR

If other than Open/Collector/Common is selected on CONFIGURATION menu, COLLECTOR current (Ic) is measured. If Open/Collector/Common is set, BASE current (Ib) is measured when the source is set to COLLECTOR.

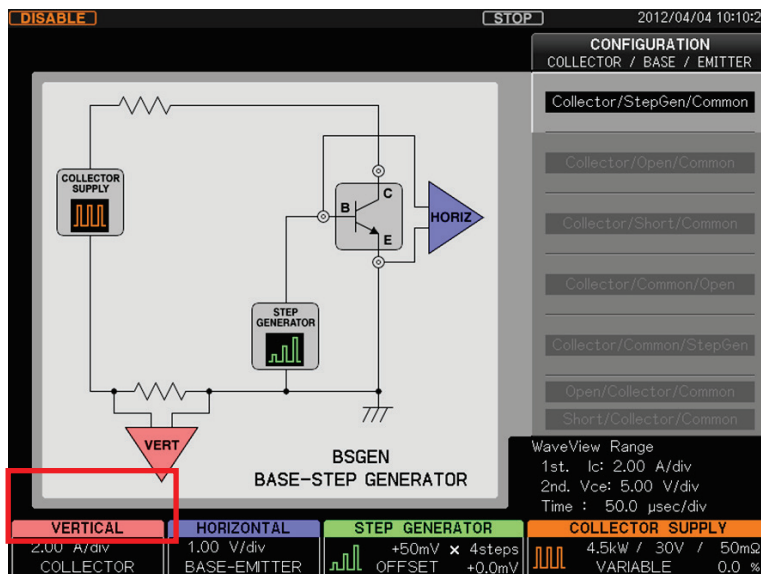

Source: EMITTER

If the collector supply is set to LEAKAGE, the source is set to EMITTER, the vertical range is increased to 1000 times, and the emitter current I_e is measured.

VERTICAL	←To left rotation	To right rotation→
Source	STEP	EMITTER
Range	Not displayed	2.00mA/div to 1.00nA/div (1-2-5 step)

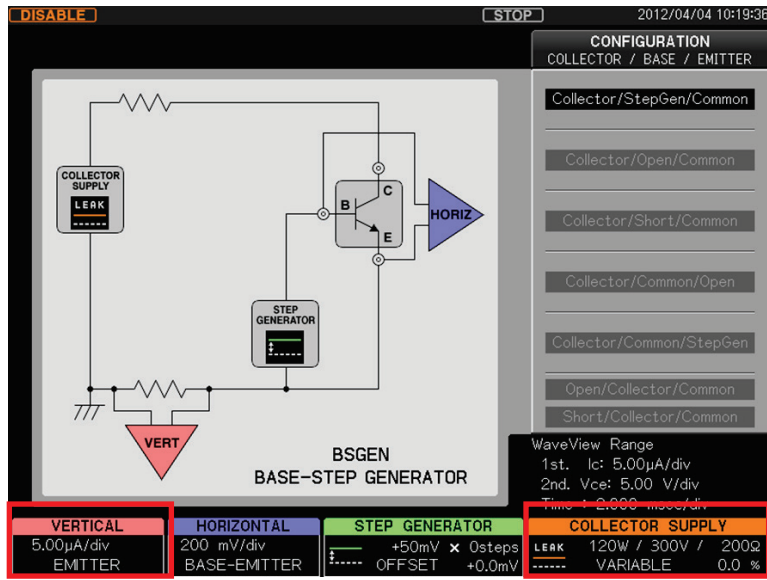

Source: STEP

If VERTICAL knob is turned fully counterclockwise, this instrument changes to STEP display and the vertical axis is fixed; i.e., 1 step of the step generator is indicated by 0.5div.

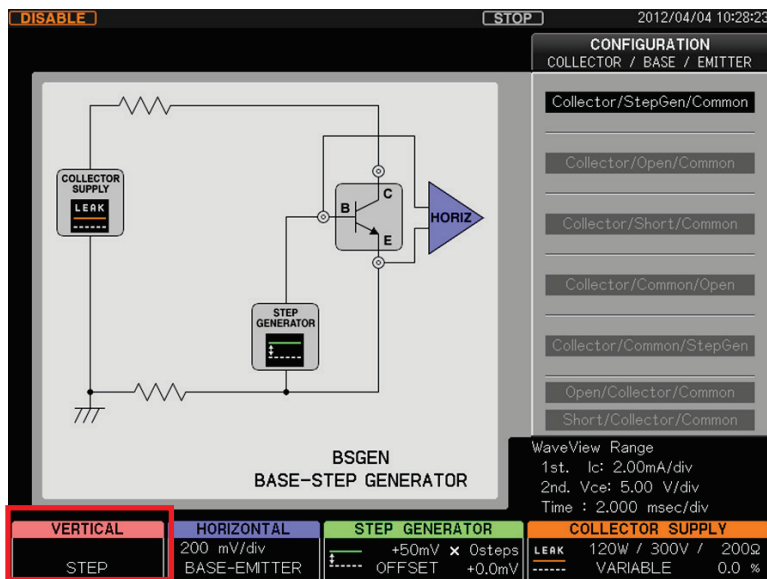

3.10 Setting DISPLAY part menus

MENU key in Section 3.10.1 explains the waveform interpolation and dot selection using VECTOR, averaging the characteristic curve data using AVERAGE, the persistence display selection using PERSISTENCE, ON/OFF of REF waveform display using REF VIEW, and capturing REF waveform in the internal memory using SAVE REF.

INVERT key in Section 3.10.2 explains ON/OFF of a reversely displayed waveform.

VIEW/PULSE key in Section 3.10.3 explains TRACE selection when measured values are used for vertical and horizontal axes and WAVE selection when a measured value is used for the vertical axis and a time is used for the horizontal axis, the pulse width and measurement point for pulse measurement.

CURSOR key in Section 3.10.4 explains use of DOT/fLINE/WINDOW cursors when measuring β (DC current amplification factor), gm (transconductance), and Ω (resistance) of characteristic curves.

ZOOM key in Section 3.10.5 explains the magnification ratio of VERTICAL and HORIZONTAL (OFF \rightarrow $\times 2 \rightarrow \times 5 \rightarrow \times 10$).

POSITION key in Section 3.10.6 explains how to set the origin to an arbitrary position in TRACE/WAVE waveforms.

* For HORIZONTAL and VERTICAL knobs, see Section 3.9.

3.10.1 MENU key

3.10.2 INVERT key

3.10.3 VIEW/PULSE key

3.10.4 CURSOR key

3.10.5 ZOOM key

3.10.6 POSITION key

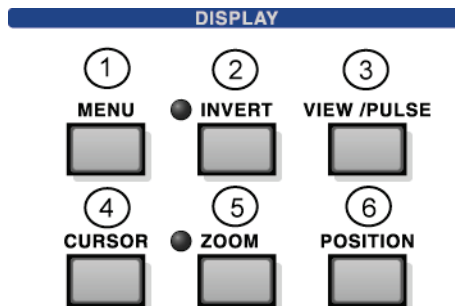

3.10.1 MENU key

Pressing MENU key ① allows "DISPLAY" menu to appear.

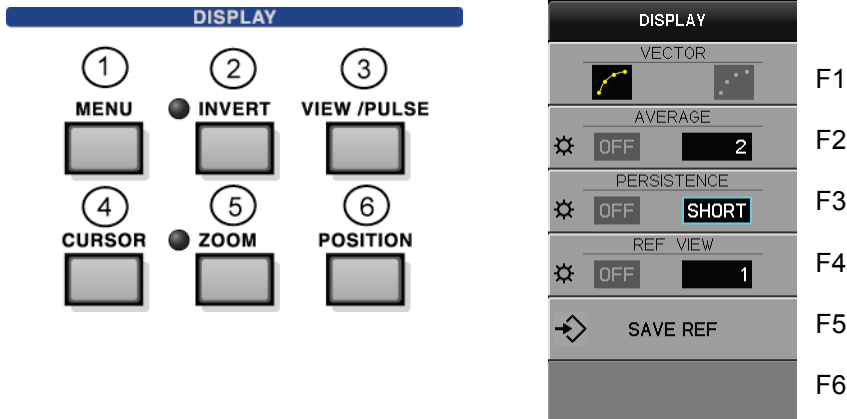

Key/knob	Submenu	Function description
F1	VECTOR	Sets the display method of waveforms; i.e., spaces between data pieces are interpolated with straight lines when being displayed or only data is displayed with dots without interpolation.
F2 FUNCTION	AVERAGE	OFF: Not averaged. Rotating FUNCTION knob allows the number of AVERAGES (2 to 255) to be set. Displays the average (Davg) of the measurement data measured by the number of times being set (n). Each time new data (Dnew) is acquired, the averaged data is calculated and displayed successively using $D_{avg_new} = (D_{avg} \times (n - 1) + D_{new}) / n$.
F3 FUNCTION	PERSISTENCE	OFF: Not display persistence. Rotating FUNCTION knob allows LONG / SHORT / INFINIT to be set. LONG: persistence display for about 2 seconds; SHORT: persistence display for about 0.5 second; INFINIT: permanent persistence display
F4 FUNCTION	REF VIEW	OFF: Not display REF waveform. Rotating FUNCTION knob allows REF number (1 to 4) to be set. Waveforms saved in the selected REF number are displayed in white lines. If the internal memory saves no REF waveform, nothing appears. (Not displayed when VIEW MODE=WAVE on VIEW/PULSE submenu.)
F5	SAVE REF	Saves the waveform currently displayed in the REF number (internal memory) set by F4. If F4 is set to OFF or VIEW MODE is set to WAVE, this key is disabled.*1
F6	(Not used)	

*1: For saving REF waveforms in USB memory, see "SAVE/RECALL key" in Section 3.11.3.

3.10.2 INVERT key

Each press of INVERT key ② changes inverse/non-inverse display of a waveform.
 In non-inverse display (normal state), LED beside INVERT key goes off and it goes on in inverse display.

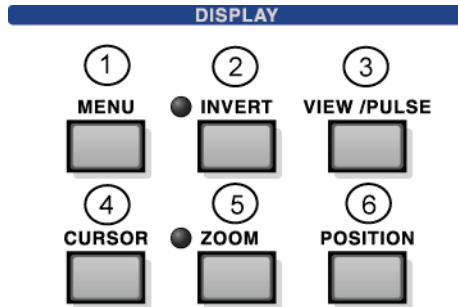

VIEW MODE and GND level display * For details of VIEW MODE, see Section 3.10.3.

TRACE	All things in the waveform display area are inverted horizontally and vertically; i.e., 180° rotation using the center of the screen as standard. The origin (GND level), waveform, and cursor are inverted. REF waveform is not inverted.
WAVE	Waveforms in WAVE 1st and 2nd are inverted vertically.

When not being inverted, the position of the origin depends on polarity settings of the collector supply and the step generator. (When the polarity is positive, the origin is at lower or left position. When it is negative, the origin is at upper or right position.)

Origin for TRACE and WAVE

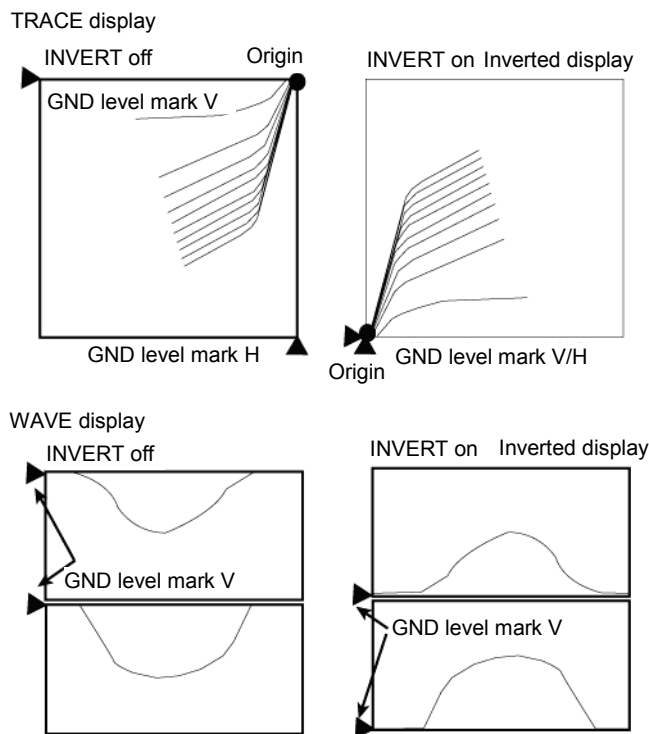

3.10.3 VIEW/PULSE key

Pressing VIEW/PULSE key ③ allows "VIEW MODE / PULSE" menu to appear.

If the collector supply is set to HIGH CURRENT MODE or if the step generator is set to PULSE, the pulse width and the measurement point can be set.

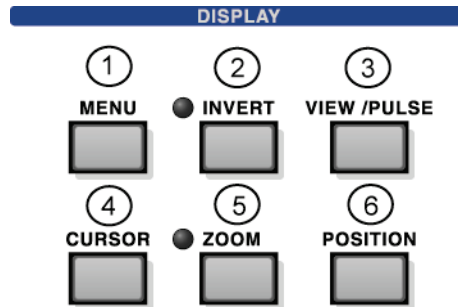

STEP measurement

PULSE measurement

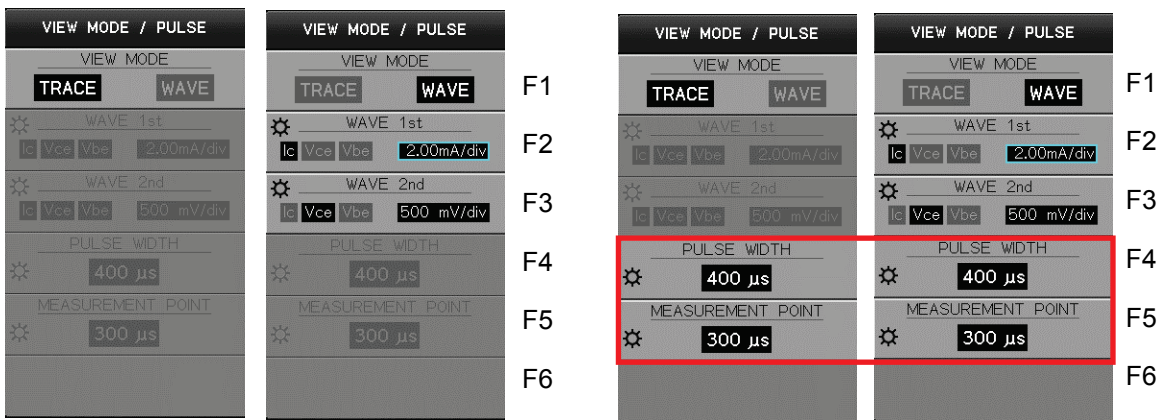

3.10.3.1 Submenus and functions

F1, F2, F3 settings

F1 setting allows F2 and F3 to change between Enable/Disable.

Submenu		Function description	
F1	VIEW MODE	TRACE	WAVE
		Displays the trace waveform with VERTICAL measurement value used for the vertical axis and with HORIZONTAL measurement value used for the horizontal axis.	Displays the waveform with the measurement value use for the vertical axis and with the time used for the horizontal axis.
F2	WAVE 1st	Disabled	F2 key is used to select Ic → Vce → Vbe of the waveform in sequence which is displayed on the WAVE 1st (upper side). Rotating FUNCTION knob allows waveform range to be set.
F3	WAVE 2nd	Disabled	F3 key is used to select Ic → Vce → Vbe of waveform in sequence which is displayed on the WAVE 2nd (lower side). Rotating FUNCTION knob allows waveform range to be set.

* For F4 to F5, see **F4 and F5 settings** (page 3-44). F6 is not used.

Note 1: If HORIZONTAL source is set to STEP, Vce=500V/div and Vbe=5.00V/div are fixed.

Note 2: If VERTICAL source is set to STEP, Ic=2.00A/div is fixed.

Range setting of Vbe / Vce / Ic when VIEW MODE=WAVE

When VIEW MODE=WAVE, range settings for Vbe / Vce / Ic of each waveform depend on the collector mode as shown below:

	COLLECTOR SUPPLY MODE	Range	Max. value
Vbe	All MODEs	5.00V, 2.00V, 1.00V, 500mV, 200mV, 100mV, 50.0mV	5.00V
Vce	High Voltage	500V, 200V, 100V, 50.0V, 20.0V, 10.0V, 5.00V, 2.00V, 1.00V, 500mV, 200mV, 100mV, 50.0mV	500V
	High Current	5.00V, 2.00V, 1.00V, 500mV, 200mV, 100mV, 50.0mV	50.0V
Ic	Leakage	2.00mA, 1.00mA, 500uA, 200uA, 100uA, 50.0uA, 5.00uA, 2.00uA, 1.00uA, 500nA, 200nA, 100nA, 50.0nA, 20.0nA, 10.0nA, 5.00nA, 2.00nA, 1.00nA	2.00mA
	High Current	200A, 100A, 50.0A, 20.0A, 10.0A, 5.00A, 2.00A, 1.00A, 500mA, 200mA, 100mA * The setting range is different according to the setting range of MAX PEAK POWER WATTS.	200A
	Others High Voltage	2.00A, 1.00A, 500mA, 200mA, 100mA, 50.0mA, 20.0mA, 10.0mA, 5.00mA, 2.00mA, 1.00mA, 500uA, 200uA, 100uA, 50.0uA, 20.0uA, 10.0uA, 5.00uA, 2.00uA, 1.00uA	2.00A

In addition, there are limitations below for range setting when setting HORIZONTAL source and VERTICAL source.

HORIZONTAL source setting			
	STEP	BASE—EMITTER	COLLECTOR
Vbe	Max. value fixed Vbe=5.00 V/div Vce=500V/div	Range setting with FUNCTION knob and range setting with VERTICAL knob operate together; i.e., the same range is generated.	FUNCTION knob allows independent setting.
Vce		FUNCTION knob allows independent setting.	Range setting with FUNCTION knob and range setting with VERTICAL knob operate together; i.e., the same range is generated.

VERTICAL source setting		
	STEP	COLLECTOR or EMITTER
Ic	Max. value fixed 2.00 A/div	Range setting with FUNCTION knob and range setting with VERTICAL knob operate together; i.e., the same range is generated.

To the way in a right figure, the range being set is displayed in the area under the menu. (When VIEW MODE is WAVE)

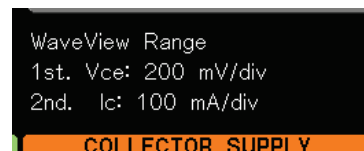

F4 and F5 settings

Settings of F4 (PULSE WIDTH) and F5 (MEASUREMENT POINT) is enabled only when the collector supply is set to HIGH CURRENT or DC and the step generator is set to PULSE waveform. When the collector supply is set to AC, RECTIFIED SINE (full-wave rectified), or LEAKAGE and the step generator is set to STEP waveform, the settings are disabled. However, it is available if the step generator is set to PULSE even if the collector supply is set to AC.

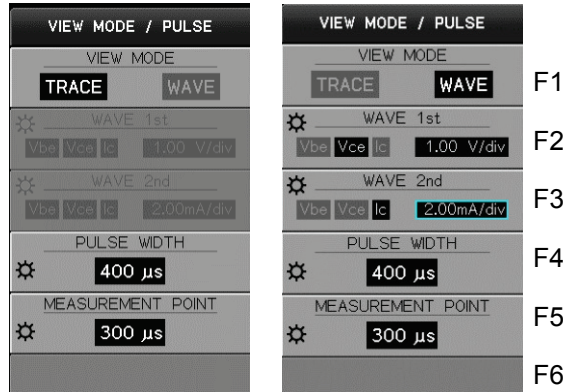

STEP GENERATOR		
	STEP	PULSE
F4	Disable	Sets the pulse width (50us to 400us, in 10us step). When the collector supply is in HGH CURRENT mode, the width of the output pulse from the step generator is wider than that of the output pulse from the collector supply; i.e., additional 100 us at each end.
F5		Sets the measurement timing (from 10us to pulse width setting value(F4), in 10us step, (Max. value: 400 us)

To set the width of pulses to be generated from the step generator, press F4 key and rotate FUNCTION knob.

To set the MEASUREMENT POINT which is adopted as the measurement value (common to HORIZONTAL and VERTICAL), press F5 key and rotate FUNCTION knob.

Step generator in PULSE setting

When VIEW MODE=WAVE, the cursor indicating the point which is adopted as the measurement value is displayed on the waveform screen.



Full scale time axis in WAVE mode

It varies depending on selection between STEP and PULSE of the step generator as shown below:

Step generator =PULSE

Full scale display 500μs (50μs/div)

Step generator =STEP

Start to finish of a cycle of the waveform set by MODE/POLARITY of the collector supply (SIN, full-wave rectified) is displayed in full scale. Ex.: For SIN, 50Hz, full scale: 20msec.

3.10.4 CURSOR key

Pressing CURSOR key ④ allows "CURSOR" menu to appear.
 Cursor display is enabled only when VIEW MODE=TRACE.

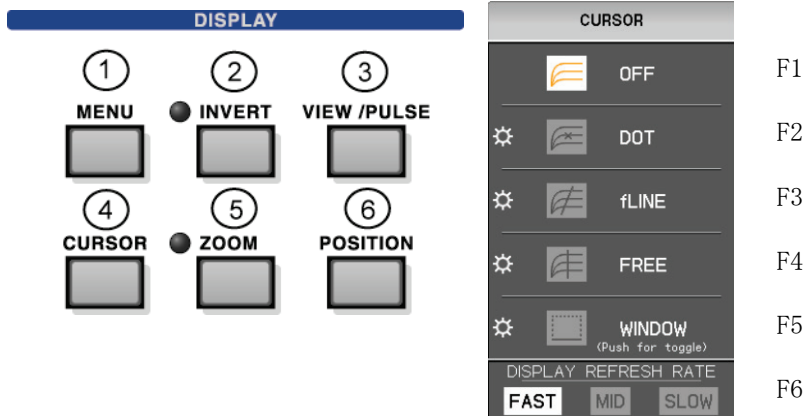

Key/knob	Submenus	Function description
F1	OFF	Sets cursor display to OFF. Deletes the label and each cursor value display under CURSOR menu.
F2 FUNCTION	DOT	Displays DOT cursor. Displays the label and each cursor value under CURSOR menu.
F3 FUNCTION	fLINE	Displays fLINE cursor. Displays the label and each cursor value under CURSOR menu.
F4 FUNCTION	FREE	Displays FREE cursor. Displays the label and each cursor value under CURSOR menu.
F5 FUNCTION	WINDOW	Displays WINDOW cursor. Displays the label and each cursor value under CURSOR menu.
F6	DISPLAY REFRESH RATE	Selects the display refreshing rate; FAST, MID, SLOW.

Cursor readout display

The readout is displayed for all cursors under CURSOR menu as shown below:

- Numeric value enclosed by () is the setting value.
- Numeric value not enclosed by () is the value obtained by calculating a measurement result.

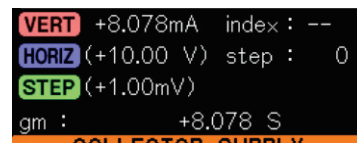

3.10.4.1 DOT cursor

It displays x-shaped cursor on the characteristic curve. Both HORIZ and VERT display the measurement value of DOT position.

Pushing FUNCTION knob allows the cursor to move to the same position (index) of the curve with the next Step number. Rotating FUNCTION knob allows the cursor to move to the measurement point (index) on the characteristic curve.

The values of vertical (VERT) and horizontal (HORIZ) axes for cursor position are displayed in the area under the menu.

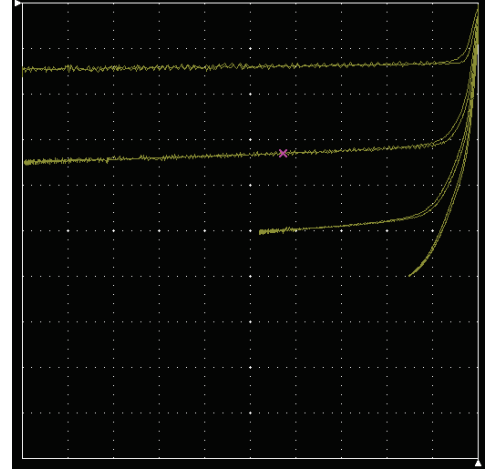
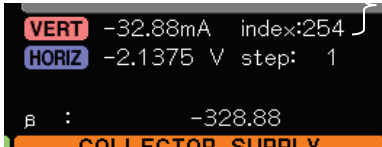

Measurement value display when multiple characteristics curves exist

When multiple characteristics curves exist as shown in the upper-right diagram, measurement values displayed in the area under CURSOR menu are classified into "index" and "step" as shown in the upper-left diagram.

- step: "0, 1, 2, ..." is displayed in the order of measuring the characteristics curve.
- index: The measurement point in DOT position is expressed.

Ex.: In the case of diagram above, the measurement point is the 254th point.

If DOT cursor is changed to fLINE cursor or FREE cursor, the value is displayed in the same manner.

Display of output level of the step generator

For DOT cursor, the output value from the step generator (STEP voltage value or STEP current value) is displayed in () which is obtained by the following calculation, as shown in the right diagram.

STEP voltage value (or STEP current value) = OFFSET value + STEP×STEP width

For FREE cursor in Section 3.10.4.3, value is displayed in the same manner.

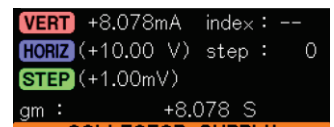

Source setting of step generator: CURRENT

β (DC current amplification factor) of the cursor position is displayed.

β = Current value at the cursor position / (STEP current × step No. of cursor position + Offset current)

If DOT cursor is changed to FREE cursor, the value is displayed in the same manner.

Source setting of step generator: VOLTAGE

gm (transconductance) is displayed.

gm = Current value at the cursor position / (STEP voltage × step No. of cursor position + Offset voltage)

Note: When the vertical axis is set to STEP, the parameter above is not calculated.

If DOT cursor is changed to FREE cursor, the value is displayed in the same manner.

3.10.4.2 fLINE cursor

It displays the straight line cursor which passes on DOT cursor specified by STEP and position (index).

Rotating FUNCTION knob allows the gradient to change.

Values of vertical axis (VERT: mA) and horizontal axis (HORIZ: V), the step number, and the index position of the cursor position being set by DOT cursor are displayed in the area under the menu.

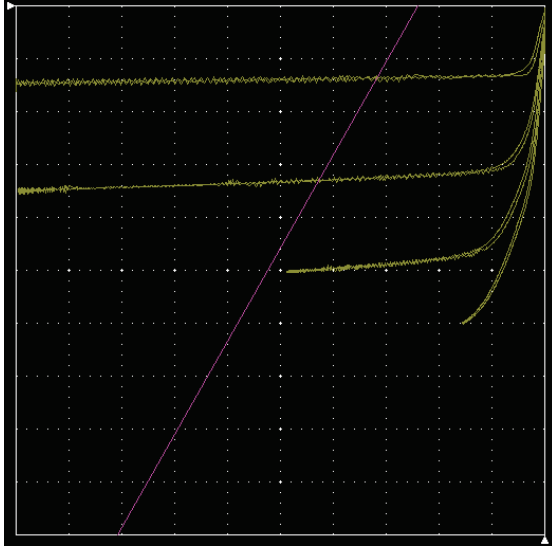

```

VERT -32.73mA  index:254
HORIZ -2.1319 V step: 1
f:1/grad 28.51 Ω
f:intercept -1.19 V
    
```

The gradient of fLINE cursor is displayed under it.

Gradient:

- When the horizontal axis is used for COLLECTOR voltage: $V_c/I_c = \text{resistance } (\Omega)$ (1/grad display)
- When the horizontal axis is used for BASE-EMITTER voltage: $I_c/V_{be} = \text{transconductance (mS)}$ (grad display).

In addition, the voltage value at the intersection point of fLINE cursor and the horizontal axis is displayed in the intercept readout. If the horizontal or vertical axis is used for STEP, no cursor appears and the parameter above is not calculated.

3.10.4.3 FREE cursor

Pressing F4 key on CURSOR menu allows the straight-line FREE cursor to appear. The FREE cursor can specify the arbitrary coordinates on the screen. The vertical axis coordinates (VERT) and the horizontal axis coordinates (HORIZ) are displayed in the area under the menu (in the frame of right example).

Each press of F4 key or FUNCTION knob toggles cursor display in the order below:

- Only one straight-line cursor in the vertical axis direction
- Only one straight-line cursor in the horizontal axis direction
- One straight-line cursor in each of the vertical and horizontal axis directions

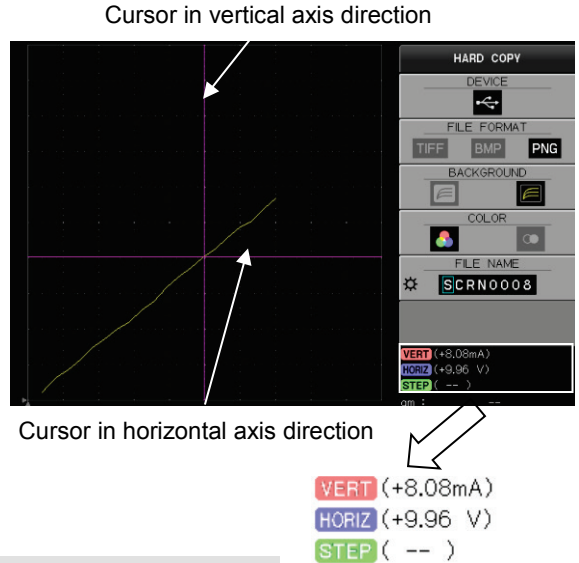

Measurement value display on the curve for specified voltage and current

DOT cursor shown in Section 3.10.4.1 moves on DOTs of the measurement value on the characteristics curve. Since DOT cursor shows the raw measurement result, the result which is completely consistent with the specified voltage (or current) cannot be obtained. In such a case, if FREE cursor is used, the result can be obtained using calculation. For FREE cursor, the current (or voltage) at that time is calculated by linear-interpolating between two points striding over the specified voltage (or current) value on the characteristics curve.

The diagram on the upper-right is the example of DOT cursor measurement. In the diagram, since HORIZ voltage value at DOT position in the horizontal direction is +1.9781V, VERT current value cannot be obtained at the exact position of HORIZ voltage value: 2.00V. Therefore, FREE cursor is used to display the cursor in the vertical axis direction (diagram on lower-right). When setting HORIZ voltage value to 2.00V, 1.3894mA which is VERT current value at that time is displayed in the area under the menu.

This example shows that HORIZ voltage value is set and inversely, VERT current value can be set to a specified current. For FREE cursor, HORIZ voltage value at that time can be read by setting VERT current value to a specified current with use of the cursor in the horizontal direction.

Note that values to be calculated are only those on the specified STEP characteristics curve. The value specified by DOT cursor is used for the STEP specified value. Therefore, when changing STEP, it is necessary to change to DOT cursor once. In addition, there are multiple intersection points between the characteristics curve and the specified voltage (current), calculation uses the intersection point with lower index value.

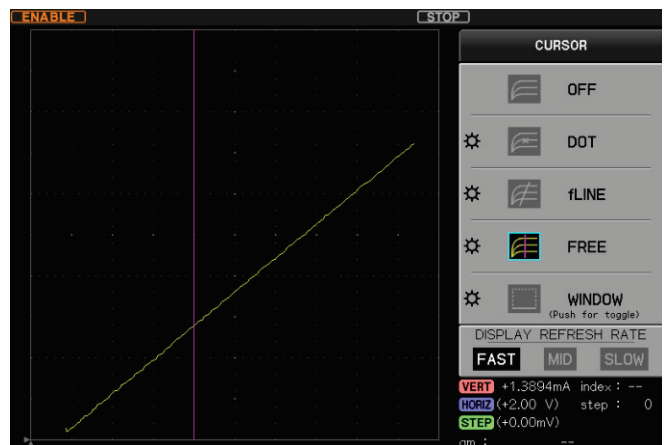

3.10.4.4 WINDOW cursor

Pressing F4 key (WINDOW) in CURSOR menu allows the rectangular cursor to appear. Use of F4 key or pushing FUNCTION knob allows a side to be moved to change one by one.

Upper left lower right



The selected side is displayed.

Rotating FUNCTION knob allows the selected side to move horizontally or vertically.

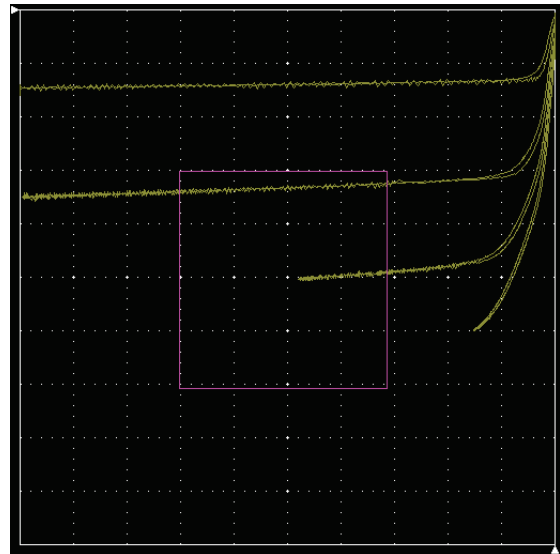

The position value of each side is displayed in the area under the menu. In addition, the height (current value) and width (voltage value) of the rectangular area are displayed.

VERT -68.4mA (upper side) — -51.8mA (lower side)
 HORIZ -8.16V (right side) — -7.96V (left side)

VERT -68.4mA — -51.8mA
 HORIZ -8.16 V — -7.96 V
 h= +16.6mA w= +0.20 V
 β : +166.00

h	Current value at lower side – current value at upper side
w	Voltage at left side – voltage at right side

β (DC current amplification factor) or g_m (transconductance) is displayed under it.

Source setting of step generator: CURRENT

$$\beta = \text{Height of rectangular area (h)} / (\text{STEP current} \times \text{step No. of cursor position} + \text{Offset current})$$

Source setting of step generator: VOLTAGE

$$g_m = \text{Height of rectangular area (h)} / (\text{STEP voltage} \times \text{step No. of cursor position} + \text{Offset voltage})$$

If the WINDOW cursor is set so that its length is equal to that between steps of curves, β or g_m at that position can be measured.

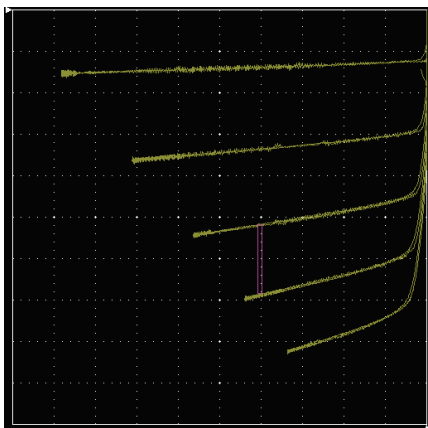

3.10.5 ZOOM key

Pressing ZOOM key ⑤ allows "ZOOM" menu to appear.

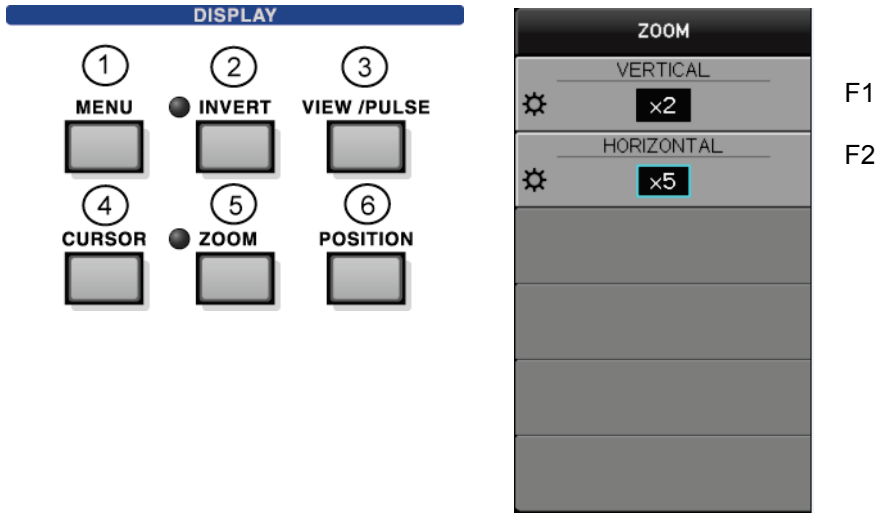

Rotating FUNCTION knob allows magnification ratio to be set.

F1	Sets the vertical magnification ratio.
F2	Sets the horizontal magnification ratio.
F3 to F6	(Not used)

Each rotation of FUNCTION knob changes OFF → × 2 → × 5 → × 10.

While the middle of the screen is used as the center, the screen is enlarged with the magnification being set.

If other than OFF is set to either of VERTICAL and HORIZONTAL, LED beside ZOOM key lights up.

In addition, the magnifying glass icon is displayed on the axis screen which sets the other than OFF as shown below:



Range display varies depending on the magnification ratio.

Ex.: OFF → 10.0mA/div, × 2 → 5.00mA/div, × 5 → 2.00mA/div, × 10 → 1.00mA/div

Note: However, if the source of VERTICAL/HORIZONTAL is set to STEP, the range screen keeps displaying STEP (without any change) and no magnification occur on the screen; i.e., setting of × 2 to × 10 can be done on the menu but the action is the same as that for OFF.

If the signal corresponding to VERTICAL or HORIZONTAL is displayed on the 1st side or 2nd side in Wave display, the waveform is enlarged using the center line as the center.

3.10.6 POSITION key

Pressing POSITION key ⑥ allows "POSITION" menu to appear.
 The origin of the characteristic curve can be set on an arbitrary position.

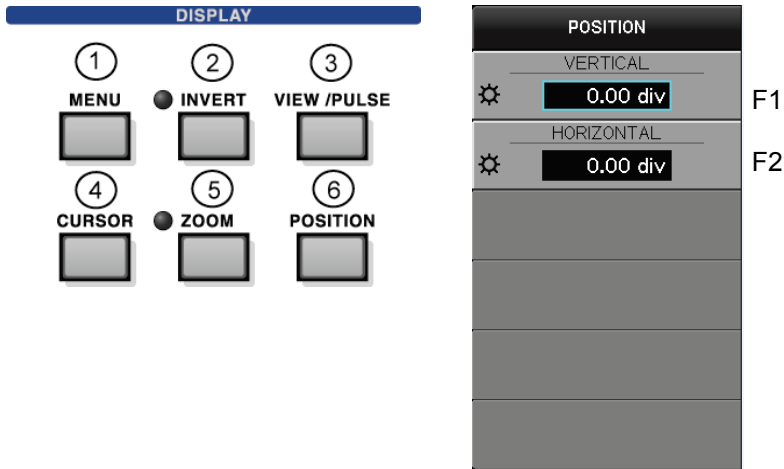







Rotating FUNCTION knob allows each position to be set.
 Pushing FUNCTION knob allows the position to be set to 0.00div.

F1	Sets the vertical position.
F2	Sets the horizontal position.
F3 to F6	(Not used)

POSITION movable area and resolution (Zoom: OFF)

- Setting resolution: 0.02 div
- The movable areas are as follows, depending on display range.
- For Invert setting, the move direction and rotation direction of FUNCTION knob are inverse.

COLLECTOR	Collector supply MODEs		
	AC 	Positive polarity other than AC 	Negative polarity other than AC 
	-5.00 to +5.00 div Zero position = center of screen	0.00 to 10.0 div Zero position = left edge or lower edge of screen	-10.0 to 0.00 div Zero position = right edge or upper edge of screen
EMITTER	Collector supply MODEs		
	Positive 	Negative 	
	0.00 to 10.0 div Zero position = left edge of screen	-10.0 to 0.00 div Zero position = right edge of screen	
BASE-EMITTER	STEP GENERATOR MODE		
	Positive 	Negative 	
	0.00 to 10.0 div Zero position = left edge of screen	-10.0 to 0.00 div Zero position = right edge of screen	
STEP	-5.00 to +5.00 div This setting is possible but the display is fixed at the specified position; cannot be moved.		

When ZOOM is set ON, POSITION movable area (Unit: div)

VERTICAL Source/range	COLLECTOR	V-Zoom= $\times 2$ times		V-Zoom= $\times 5$ times		V-Zoom= $\times 10$ times	
		Min.	Max.	Min.	Max.	Min.	Max.
COLLECTOR	AC	-15	15	-45	45	-95	95
	+SIN	-5	25	-20	70	-45	145
	-SIN	-25	5	-70	20	-145	45
	+DC	-5	25	-20	70	-45	145
	-DC	-25	5	-70	20	-145	45
EMITTER	+LEAK	-5	25	-20	70	-45	145
	-LEAK	-25	5	-70	20	-145	45
COLLECTOR	+HC	-5	25	-20	70	-45	145
	-HC	-25	5	-70	20	-145	45
STEP	—	-15	15	-45	45	-95	95

HORIZONTAL Source/range	COLLECTOR	STEP GEN	H-Zoom= $\times 2$ times		H-Zoom= $\times 5$ times		H-Zoom= $\times 10$ times	
			Min.	Max.	Min.	Max.	Min.	Max.
COLLECTOR	AC	—	-15	15	-45	45	-95	95
	+SIN	—	-5	25	-20	70	-45	145
	-SIN	—	-25	5	-70	20	-145	45
	+DC	—	-5	25	-20	70	-45	145
	-DC	—	-25	5	-70	20	-145	45
	+LEAK	—	-5	25	-20	70	-45	145
	-LEAK	—	-25	5	-70	20	-145	45
	+HC	—	-5	25	-20	70	-45	145
	-HC	—	-25	5	-70	20	-145	45
BASE	—	+STEP	-5	25	-20	70	-45	145
	—	-STEP	-25	5	-70	20	-145	45
	—	+PULSE	-5	25	-20	70	-45	145
	—	-PULSE	-25	5	-70	20	-145	45
STEP	—	—	-15	15	-45	45	-95	95

3.11 Setting SYSTEM part menus

- 3.11.1 UTILITIES key
- 3.11.2 COPY key
- 3.11.3 SAVE/RECALL key
- 3.11.4 Setting of SAVE/RECALL/DELETE
- 3.11.5 CONFIGURATION key
- 3.11.6 AUX key
- 3.11.7 APPLICATION key
- 3.11.8 Default settings

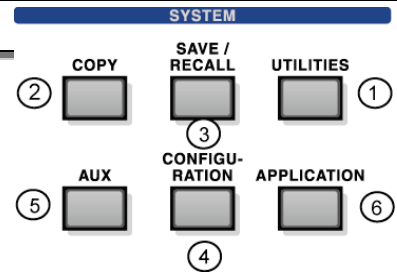

SYSTEM menu tree

The diagram below shows the tree structure (system diagram) of SYSTEM menu. The part of lower APPLICATION KEY is optional.

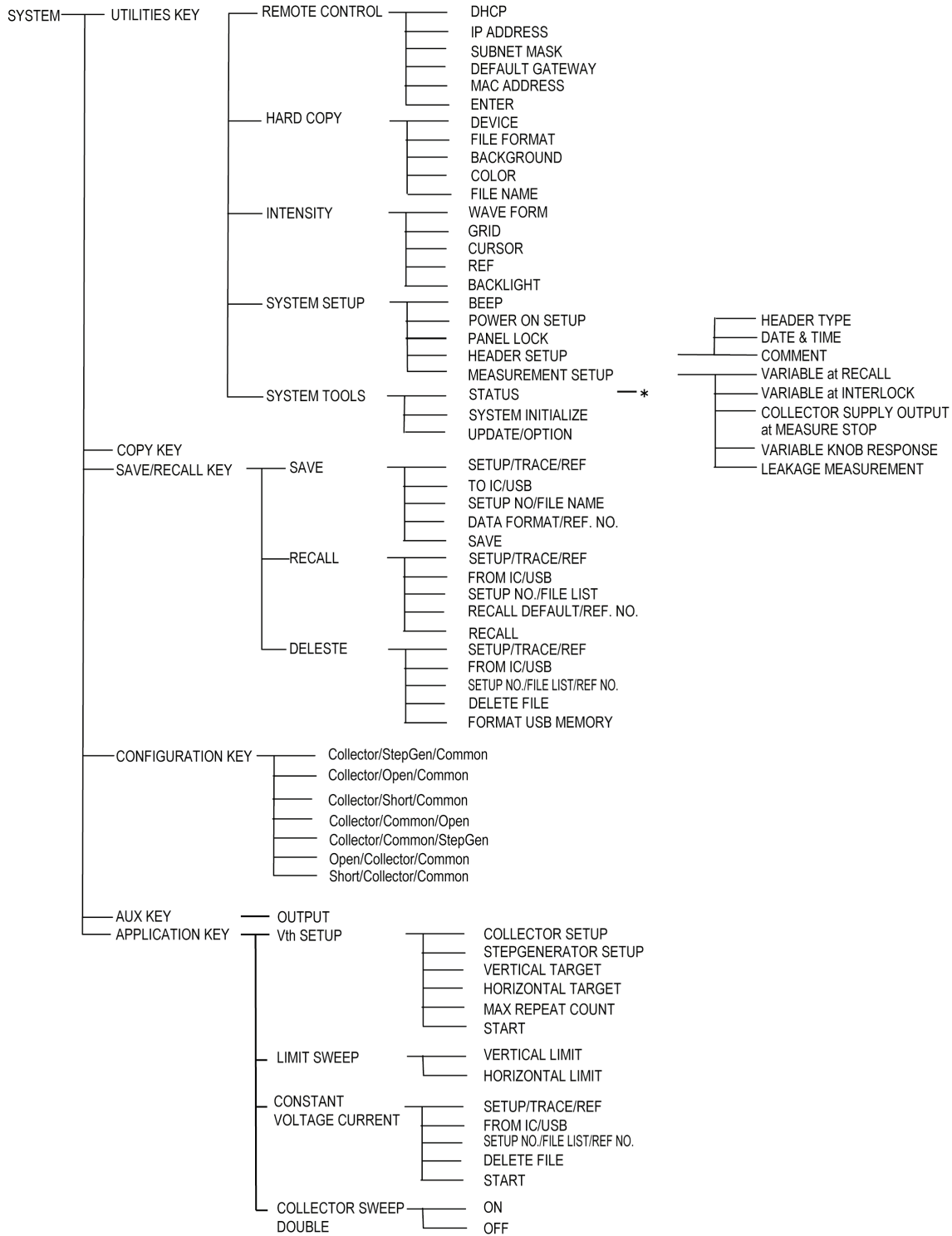

* Model, Serial No., System ID., Software Version., Software Verification Code., Product ID., Installed Option

3.11.1 UTILITY key

Pressing UTILITY key ① allows "UTILITY" submenu to appear.

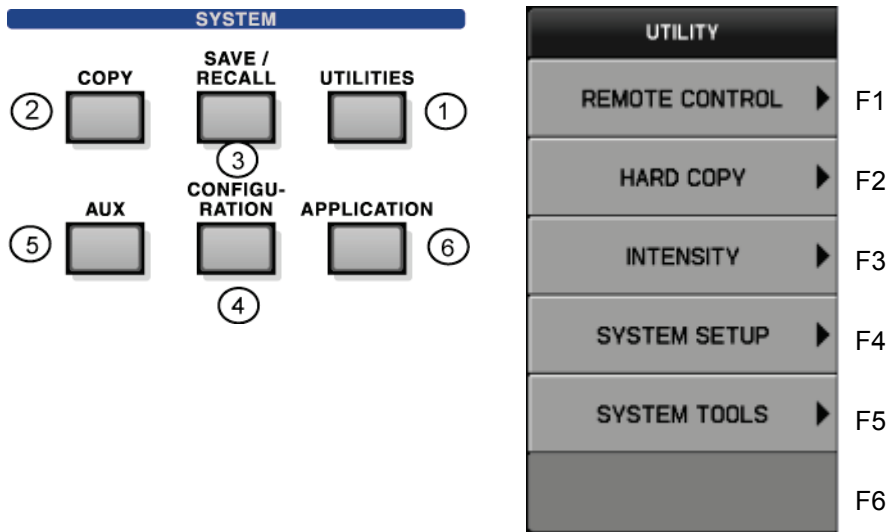

3.11.1.1 REMOTE CONTROL submenu

3.11.1.2 HARD COPY submenu

3.11.1.3 INTENSITY submenu

3.11.1.4 SYSTEM SETUP submenu

3.11.1.5 SYSTEM TOOLS submenu

3.11.1.6 Updating firmware in instrument

3.11.1.7 Installation of optional software

3.11.1.1 REMOTE CONTROL submenu

Pressing F1 key allows REMOTE CONTROL detail setting submenu to appear.
 Since the remote control is done through LAN, LAN setting is explained here.
 When DHCP is set to OFF, FUNCTION knob icon appears.
 Pressing FUNCTION knob allows the figure in the address column to move.

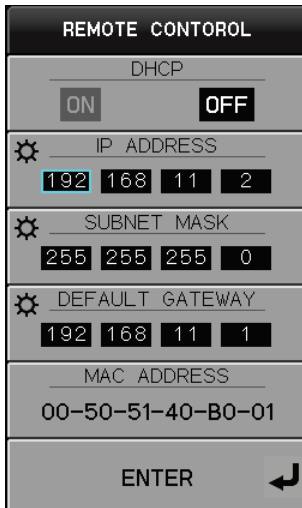

NO.	Submenu	Function description
F1	DHCP	Selects DHCP ON/OFF. *1
F2	IP ADDRESS	DHCP ON: Displays IP address. DHCP OFF: Sets IP address.
F3	SUBNET MASK	DHCP ON: Displays the subnet mask. DHCP OFF: Sets the subnet mask.
F4	DEFAULT GATEWAY	DHCP ON: Displays the default gateway. DHCP OFF: Sets the default gateway.
F5	MAC ADDRESS	Displays MAC address.
F6	ENTER	Enables the settings. If the setting is changed, it is necessary to restart this instrument .

*1

If DHCP = ON, the address (IP ADDRESS, SUBNET MASK, DEFAULT GATEWAY) acquired from DHCP server is displayed when being activated.

If DHCP = OFF, the setting values previously being set are displayed.

In addition, if DHCP = OFF at activation and then DHCP is changed to ON after activation, the address at DHCP = OFF is displayed without any change.

3.11.1.2 HARD COPY submenu

The menu sets the file type, background color, color/gray scale, and file name when saving the screen hard copy in the USB memory.

Pressing F2 key allows submenu "HARD COPY" to appear.

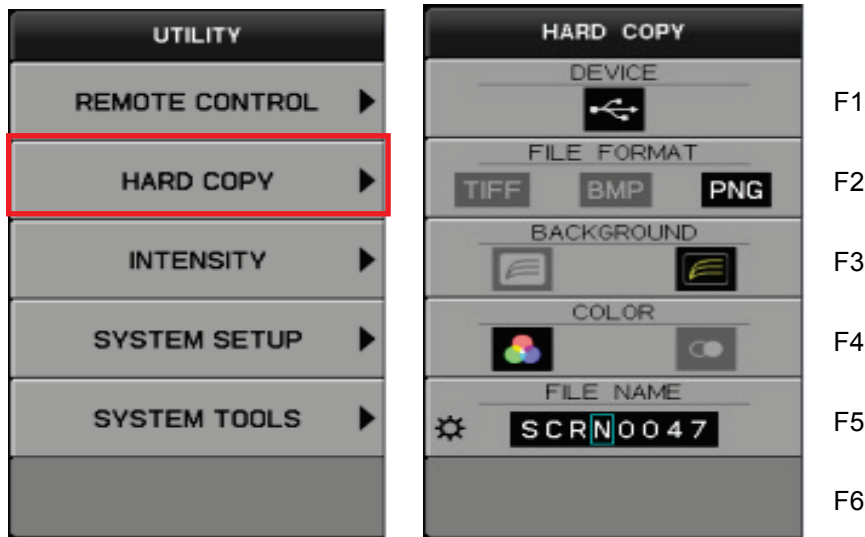

NO.	Submenus	Function description
F1	DEVICE	Only USB memory is used for hard copy device.
F2	FILE FORMAT	Selects the file format; TIFF, BMP, and PNG.
F3	BACKGROUND	Changes white/black of the background color.
F4	COLOR	Changes color/gray scale.
F5	FILE NAME	Sets the file name: 4 alphanumeric characters and 4 numeric characters. One of TIFF/BMP/PNG is added to the file name.
F6		(Not used)

How to set file name:

Function key	Each press of this key (each press of FUNCTION knob) allows the setting figure to move to the right.
FUNCTION knob	Selects a value one by one. 4 characters on the left: alphabet: 0 to 9, A to Z ! # \$ % & ' () - ^ _ { } ~ 4 characters on the right: numeric 0 to 9

To execute the hard copy actually, press COPY key.

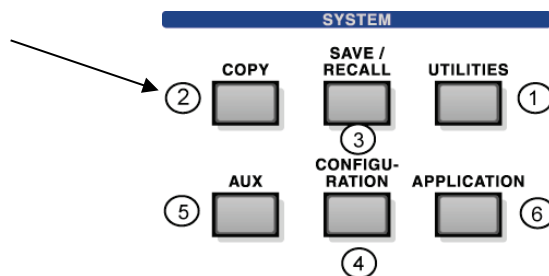

3.11.1.3 INTENSITY submenu



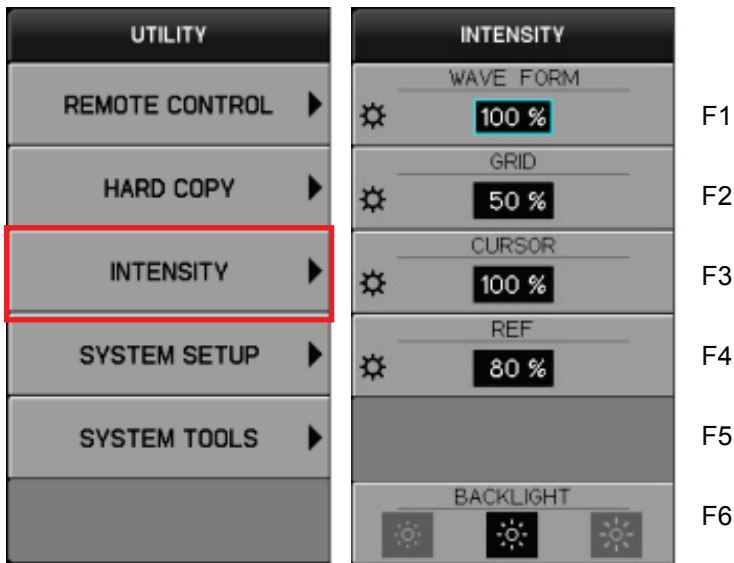

Pressing F3 key allows submenu "INTENSITY" to appear.
 Rotating FUNCTION knob allows the brightness setting from 25% to 100%.





NO.	Submenus	Function description
F1	WAVE FORM	Sets the brightness of a waveform (25% to 100%, 5% step).
F2	GRID	Sets the brightness of grids (25% to 100%, 5% step).
F3	CURSOR	Sets the brightness of cursors (25% to 100%, 5% step).
F4	REF	Sets the brightness of a REF waveform (25% to 100%, 5% step).
F5		(Not used)
F6	BACKLIGHT	Sets the brightness of the LCD backlight. Each press of F6 key changes dark/middle/light.

3.11.1.4 SYSTEM SETUP submenu

Pressing F4 key allows the submenu "SYSTEM SETUP" to appear.

	UTILITY	SYSTEM SETUP
F1	REMOTE CONTROL ▶	BEEP  
F2	HARD COPY ▶	POWER ON SETUP DEFAULT LAST
F3	INTENSITY ▶	PANEL LOCK  
F4	SYSTEM SETUP ▶	HEADER SETUP ▶
F5	SYSTEM TOOLS ▶	MEASUREMENT SETUP ▶
F6		

NO.	Submenus	Function description
F1	BEEP	When set to ON, the operation tone and error tone sound for key/knob operation. When set to OFF, no tone sound.
F2	POWER ON SETUP	DEFAULT: This instrument starts with the initial state. LAST: This instrument starts with the state when it is powered off previously.
F3	PANEL LOCK	The panel key can be invalidated excluding the ENABLED/DISABLED breaker switch of collector supply output (HIGH VOLTAGE/HIGH CURRENT) and the FUNCTION key to PANEL LOCK and the CLEAR key. By pushing the F3 key one by one, on/off of the panel lock function is selected.  :ON state. The panel key becomes invalid excluding the above-mentioned switch and the key.  :OFF state. All switches and the panel keys become effective.
F4	HEADER SETUP	The HEADER SETUP submenu opens by pushing the F4 key. The selection of the type, the date, and the time for the header displayed on the right of the screen can be set. For how to set, see Section 3.11.1.4.1.
F5	MEASUREMENT SETUP	The MEASUREMENTSETUP submenu opens by pushing the F5 key. For how to set, see Section 3.11.1.4.2.
F6		(Not used)

3.11.1.5 HEADER SETUP submenu

The header information displayed on the right of the screen is set on the HEADER SETUP submenu.

SYSTEM SETUP submenu is displayed by pushing F4 function key.





Next, HEADER SETUP submenu is displayed by pushing F4 function key.

UTILITY	SYSTEM SETUP	HEADER SETUP	
REMOTE CONTROL ▶	BEEP  	HEADER TYPE DATE COMM. CONF. OFF	F1
HARD COPY ▶	POWER ON SETUP DEFAULT LAST	DATE & TIME ▶	F2
INTENSITY ▶	PANEL LOCK  	COMMENT ▶	F3
SYSTEM SETUP ▶	HEADER SETUP ▶		F4
SYSTEM TOOLS ▶	MEASUREMENT SETUP ▶		F5
			F6

NO.	Submenus	Function description
F1	HEADER TYPE	The type of the header displayed on the right of the screen is selected. The following set item can be selected by pushing the F1 key one by one. DATE : The date and time are displayed in the header. Refer to paragraph 3.11.1.4.1.2 for the method of setting time at the date. COMM. : The content of COMMENT (comment) set by following TXIT EDIT submenu is displayed in the header. Refer to paragraph 3.11.1.4.1.2 for the method of setting COMMENT (comment). CONF. : The connected name and state of collector, base, and emitter terminal with collector supply, step generator EXT(AUX), and Common are set with the CONFIGURATION key and displayed in the header. Refer to paragraph 3.11.1.4.1.2 for the method of setting the connected name and state OFF : It is not displayed in the header.
F2	DATE & TIME	The DATE & TIME submenu opens by pushing F2 key. Refer to paragraph 3.11.1.4.1.1 for the method of setting time at the date.
F3	COMMENT	The TXIT EDIT submenu opens by pushing F3 key. Refer to paragraph 3.11.1.4.1.2 for the method of setting COMMENT (comment).
F4~F6		(Not used)

3.11.1.5.1.1 DATE & TIME submenu

DATE & TIME submenu is used to set the date and time.
 Pressing F4 key allows the submenu "SYSTEM SETUP" to appear.
 Next, pressing F4 key allows the submenu "HEADER SETUP" to appear.
 Next, pressing F2 key allows the submenu "DATE & TIME" to appear.

UTILITY	SYSTEM SETUP	HEADER SETUP	DATE & TIME	
REMOTE CONTROL ▶	BEEP  	HEADER TYPE DATE COMM. CONF. OFF	2010/10/25 09:41:57	F1
HARD COPY ▶	POWER ON SETUP DEFAULT LAST	DATE & TIME ▶	YEAR 2010	F2
INTENSITY ▶	PANEL LOCK  	COMMENT ▶	MONTH / DAY 10 / 25	F3
SYSTEM SETUP ▶	HEADER SETUP ▶		HOUR : MIN 09 : 41	F4
SYSTEM TOOLS ▶	MEASUREMENT SETUP ▶			F5
			ENTER ↵	F6

NO.	Submenu	Function description
F1		Displays the current time in Christian Era.
F2	YEAR	Sets Christian Era year: 2000 to 2099.
F3	MONTH/DAY	Sets month/day: month: 1 to 12, day: as shown in calendar.
F4	HOUR: MIN	Sets hour/minute: 00:00 to 23:59.
F5		(Not used)
F6	ENTER	Enables the settings. Input of ENTER allows the settings to be reflected in this instrument.

[Procedure]

- (1) On DATE & TIME submenu, press F2 key and rotate FUNCTION knob to set Christian Era year.
- (2) Press F3 key to select "MONTH" and rotate FUNCTION knob to set the month.
- (3) Press F3 key to select "DAY" and rotate FUNCTION knob to set the day.
- (4) Press F4 key to select "HOUR" and "MIN" and rotate FUNCTION knob to set "Hour" and "Minute".
- (5) Press F6 key to enable the settings.

The display of year/month/day and Hour/minute at the upper part on the menu screen is updated.

3.11.1.5.1.2 TEXT EDIT submenu

TEXT EDIT submenu allows a comment to be set.
 Pressing F4 key allows the submenu "SYSTEM SETUP" to appear.
 Next, pressing F4 key allows submenu "HEADER SETUP" to appear.
 Next, pressing F3 key allows submenu "TEXT EDIT" to appear.

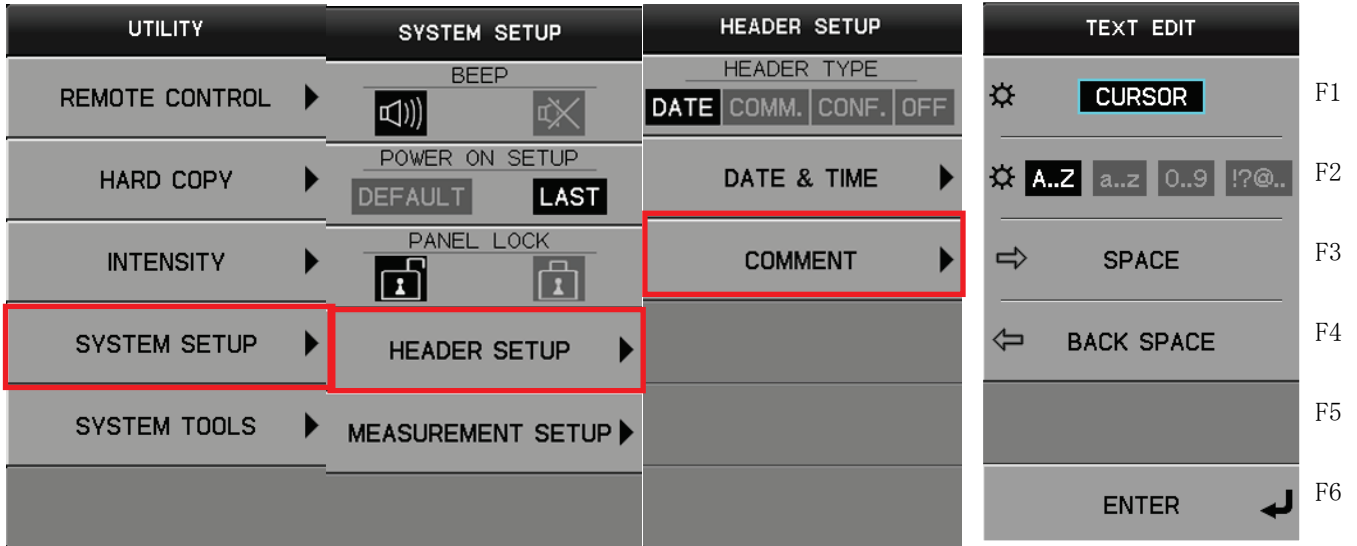

Key/knob	Setting items	Function description
F1 FUNCTION	CURSOR	Rotation of FUNCTION knob allows the cursor position in the comment field to move.
F2 FUNCTION	Character type	Use of F2 key or rotation of FUNCTION knob allows types of characters to be entered to be selected from capital letters (A to Z), small letters (a to z), numeric value (0 to 9), and symbols (!?@..). Rotation of FUNCTION knob allows the selected character to be entered in the comment creation plate.
F3	SPACE	Each press of F3 key inserts the space of one character at the cursor position in the comment field.
F4	BACK SPACE	Each press of F4 key deletes one character ahead of the cursor position in the comment field.
F5		(Not used)
F6	ENTER	F6 determines characters entered in the comment field and displays COMMENT.

* For names in TEXT EDIT menu and operation procedure, see next page.

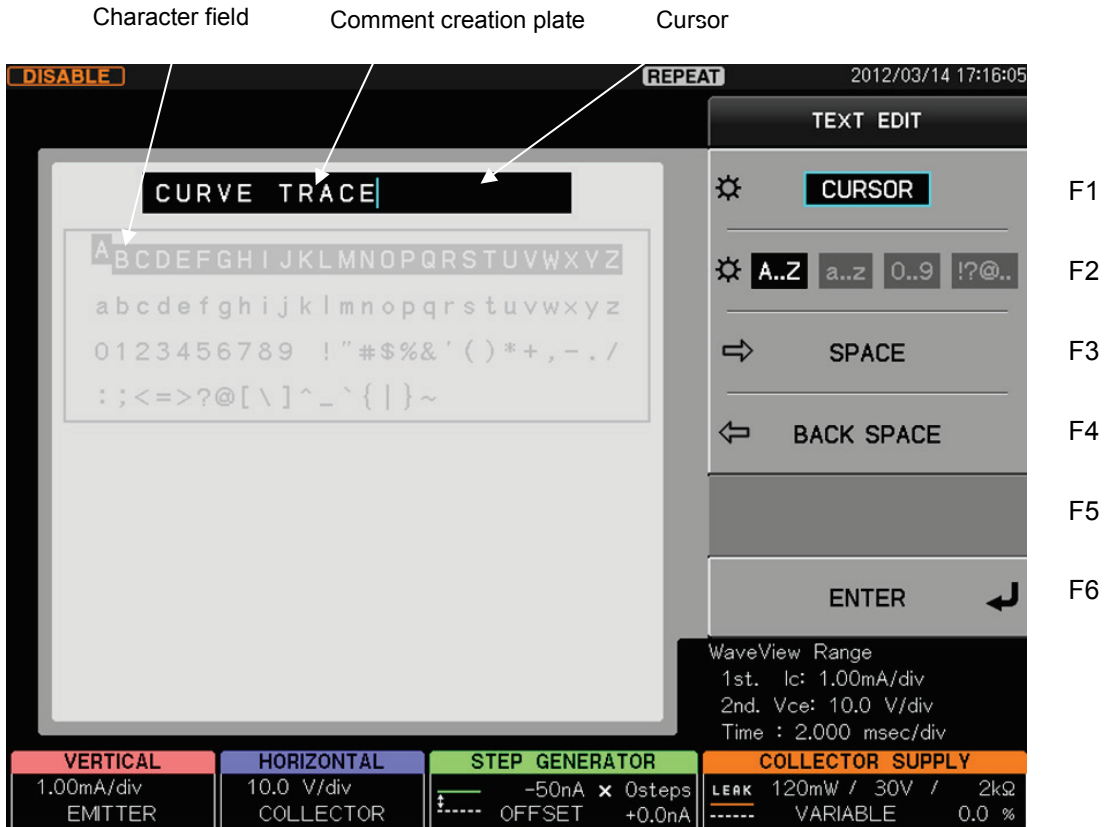

[Procedure]

- ① Press F1 key on TEXT EDIT submenu (upper diagram) or rotate FUNCTION knob to specify the cursor position.
 - ② Use F2 key or rotate FUNCTION knob to move the cursor to the character type to be entered; "A to Z", "a to z", "0 to 9, ! ? @..."(Character field).
 - ③ Pressing FUNCTION knob allows the selected characters to be entered in the comment creation plate.
 - ④ Repeat steps ①, ②, and ③ to create the comment.
 - ⑤ Press F6 key to decide the comment.
- * Refer to the table of last page for SPACE and BACK SPACE of the TEXT EDIT submenu.

3.11.1.5.2 MEASUREMENT SETUP submenu

MEASUREMENT SETUP submenu sets actions related to measurement.

Press of F4 function key displays the submenu "SYSTEM SETUP."

Next, press of F5 function key displays the submenu "MEASUREMENT SETUP."

There are two pages in MEASUREMENT SETUP submenu like the right of the figure below.

Refer to the table since next page for each PAGE explanation of the submenu.

UTILITY	SYSTEM SETUP	MEASUREMENT SETUP	MEASUREMENT SETUP	
REMOTE CONTROL ▶	BEEP [Speaker icon] [Mute icon]	VARIABLE at RECALL RECALL 0.0%	VARIABLE KNOB RESPONSE NORMAL QUICK	F1
HARD COPY ▶	POWER ON SETUP DEFAULT LAST	VARIABLE at INTERLOCK HOLD 0.0%	LEAKAGE MEASUREMENT AVERAGE POINT	F2
INTENSITY ▶	PANEL LOCK [Lock icon] [Unlock icon]	COLLECTOR SUPPLY OUTPUT at MEASURE STOP OFF LEAK ONLY ALL		F3
SYSTEM SETUP ▶	HEADER SETUP ▶			F4
SYSTEM TOOLS ▶	MEASUREMENT SETUP ▶			F5
		NEXT PAGE ▶	PREV PAGE ▶	F6

< The first page of MEASUREMENT SETUP submenu >

NO.	Submenu	Function description
F1	VARIABLE at RECALL	<p>Sets whether Variable setting of the collector supply output is restored when recalling the setup.</p> <ul style="list-style-type: none"> - RECALL: The collector supply output is restored to the stored Variable setting value. - 0.0%: The collector supply output is set to 0.0% regardless of the stored Variable setting value.
F2	VARIABLE at INTERLOCK	<p>Sets whether Variable setting of the collector supply output is held when interlock occurs.</p> <ul style="list-style-type: none"> - HOLD: When interlock occurs, the collector supply output stops but Variable setting value is held. When interlock is released, the collector supply output is restarted in accordance with Variable setting value. - 0.0%: When interlock occurs, the collector supply output is reset to 0.0%. When interlock is released, the collector supply output is held to 0.0%.
F3	COLLECTOR SUPPLY OUTPUT at MEASURE STOP	<p>Sets the status of the collector supply output in measurement STOP status. It is usually recommended to use like LEAK ONLY of the default configuration among three following kinds of settings for safety.</p> <ul style="list-style-type: none"> - OFF: <ul style="list-style-type: none"> In all modes (AC,RECTIFIED SINE,DC,LEAKAGE), stop the output of the collector supply. It enters the state of Over load by the rush electric current when it changes to might the stop of the measurement, the influence of the change of the collector voltage of beginning on the measurement result for LEAKAG E mode, and the state of output ON, there is a possibility that the measurement stops, and use it after confirming there is no problem. - LEAK ONLY (default setting): <ul style="list-style-type: none"> Stop the output of the collector supply. However, do not stop the collector supply output while the measurement even is stopping because the change of the output of the collector supply influences the measurement only at LEAKAG E mode - ALL: <ul style="list-style-type: none"> Continue the output of the collector supply. Set only when the change of the collector supply output according to the measured change influences the measurement.
F4 to F5		(Not used)
F6	NEXT PAGE	The menu is switched to NEXT PAGE by pushing F6 key.

< The second page of MEASUREMENT SETUP submenu >

NO.	Submenu	Function description
F1	VARIABLE KNOB RESPONSE	<p>The VARIABLE knob sets the output voltage of the collector supply at the rate to the maximum peak voltage setting value. When the VARIABLE knob is turned, the collector supply voltage can be continuously set from 0 % to 100 % in 0.1% step</p> <p>The response (change rate) when the VARIABLE knob is turned can be set by two stages of the following.</p> <p>NORMAL: Usual response (change rate)</p> <p>QUICK : The response (change rate) quickens.</p>
F2	LEAKAGE MEASUREMENT	<p>When the MODE setting of the collector supply is set to LEAKAGE and the current of the emitter is measured, the measurement mode can be selected from the following.</p> <ul style="list-style-type: none"> - AVERAGE: When measuring it, the leveling processing is done - POINT: When measuring it, the leveling processing is not done, and the measurement value is sampled every intervals of time.
F3~F5		(Not used)
F6	PREV PAGE	The menu is switched to PREV PAGE by pushing F6 key.

3.11.1.6 SYSTEM TOOLS submenu

Pressing F5 key allows the submenu "SYSTEM TOOLS" to appear.

UTILITY	SYSTEM TOOLS	
REMOTE CONTROL ▶	STATUS	F1
HARD COPY ▶	SYSTEM INITIALIZE ↵	F2
INTENSITY ▶	UPDATE / OPTION ▶	F3
SYSTEM SETUP ▶		F4
SYSTEM TOOLS ▶		F5
		F6

Key	Submenus	Function description
F1	STATUS	Displays the system status (Model, Serial No, System ID, Software Version, Software Verification Code, Product ID, Installed Option) in the waveform display area.
F2	SYSTEM INITIALIZE	Initializes all internal settings. It initializes default settings in "Table 3.11.1: Settings to be recalled" and "Table 3.11.2: Settings not to be recalled" of Section 3.11.8.
F3	UPDATE/ OPTION	Updates the software (see Section 3.11.1.9) or install options (see Section 3.11.1.10).
F4 to F6		(Not used)

Example of SYSTEM STATUS menu

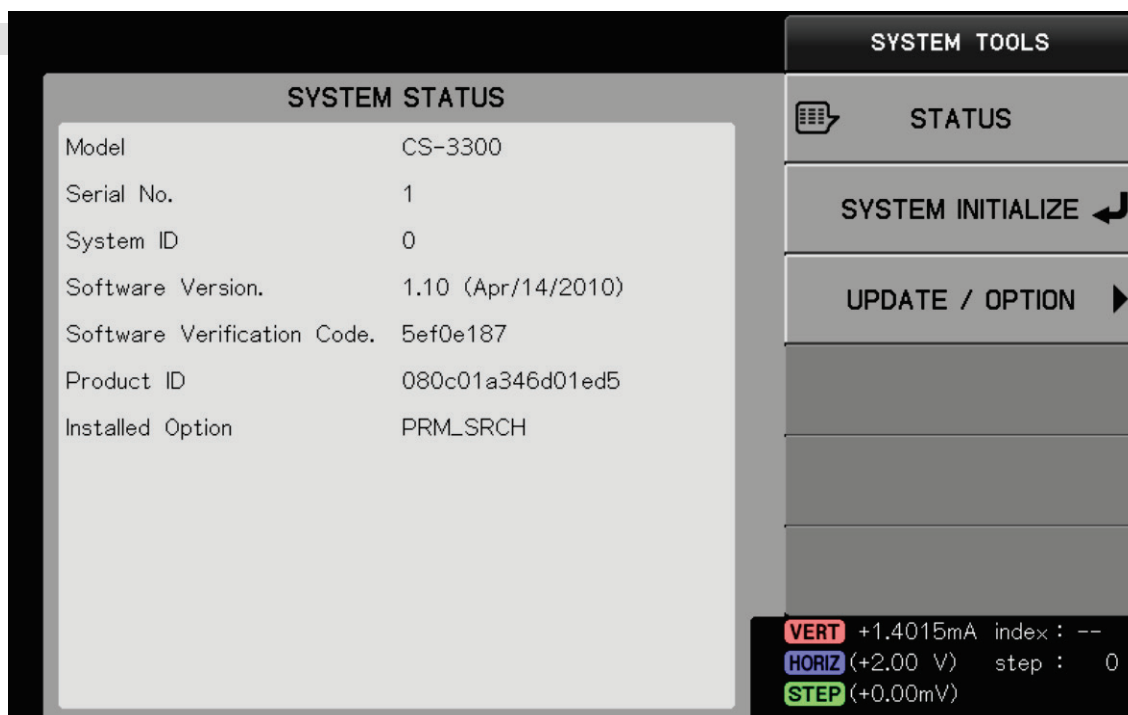

Executing SYSTEM INITIALIZE

Caution!

Execution of SYSTEM INITIALIZE initializes all internal settings. Necessary data of SETUP (setting conditions), TRACE (waveform data), and REF (reference waveform data) should be saved in the USB memory using SAVE function (see Sections 3.11.3 and 3.11.4) in SAVE/RECALL menu. For initialized items, see the default setting items in "Table 3.11.1: Recall function" and "Table 3.11.2 Not recall function" of Section 3.11.8.

[Procedure]

- (1) Press F2 key. The confirmation screen (Do you initialize system? Push [OK] button to initialize. Push [CANCEL] button to abort.) appears.
- (2) Press [OK] button. The confirmation screen (System initialization completed. Remote I/F setup changed. Reboot for new remote setup.) appears.
- (3) Restart this instrument using Power On/Standby switch.

3.11.1.7 Updating software in instrument

Use of SYSTEM TOOLS submenu can update the software programs*¹ in the instrument. When updating, attention should be paid to cautions below:

*1: Normally, our industry expresses the software in this instrument as "Firmware soft" but this instrument uses "SOFTWARE" in the screen menus and "Software in the instrument" in this document. The optional software is generically named as "Option soft" in this document and the execution file of "Option soft" as "Option file".

Caution !

- 1) When updating the software in the instrument, never set the power supply to standby or remove the USB memory.
- 2) When the renewal of the software in the instrument is completed and the instrument reactivates, the renewal of internal hardware might be executed. In this case, please never make the power supply a standby while updating the software in the instrument.
- 3) For updating the software in the instrument, contact our sales distributor or our Web site to confirm adaptability for each device (URL:<http://www.iti.iwatsu.co.jp>).
- 4) Updating the software in the instrument causes all the internal settings to be initialized. Necessary data of SETUP (setting conditions), TRACE (waveform data), and REF (reference waveform data) should be saved in the USB memory using SAVE function (see Sections 3.11.3 and 3.11.4) in SAVE/RECALL menu. For initialized items, see the default setting items in "Table 3.11.1: Recall function" and "Table 3.11.2 Not recall function" of Section 3.11.8.
- 5) When saving the file in the software of this instrument in the USB memory, to be sure to enter in "FIRMWARE" folder. If not, an error may occur and the software cannot be updated.

When updating, follow [Procedure] below:

[Procedure] Updating the software in the instrument

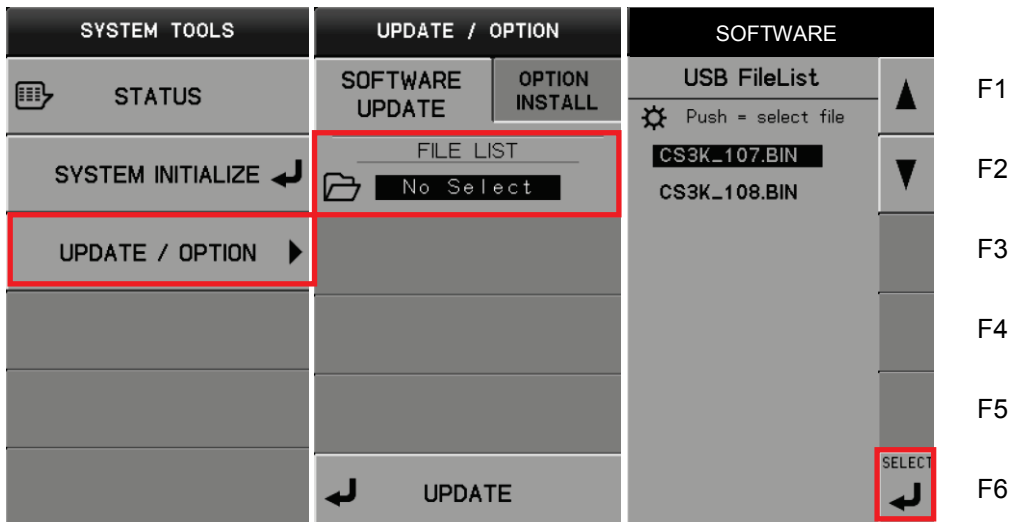

- ① Save the software file of this instrument in "FIRMWARE" folder in USB memory.
- ② Connect the USB memory saving the software files of this instrument to the connector on the left of the front of the instrument.
"USB memory available" appears on the upper side of screen.
- ③ Press UTILITIES key to open SYSTEM TOOLS menu.
- ④ Press F3 key to display UPDATE/OPTION submenu (at the center in the diagram above).
- ⑤ Press F2 key to display SOFTWARE submenu (on the right in the diagram above).
The software file of this instrument in FIRMWARE folder is displayed in USB FileList.
Simultaneously, the relationship between the file including the cursor in the submenu and the current software file of this instrument is displayed as shown in SOFTWARE UPDATE STATUS screen.



2nd to 4th lines in the diagram on the left indicate the current version of the software of this instrument (date and System ID) and 5th to 7th lines indicate the version (date and System ID) of the software saved in USB memory which is to be updated.

- ⑥ Use of the comment displayed on the 8th line in the diagram above allows continuing/finishing update to be judged.
 - a) If the comment is "This file is new version."
⇒ Proceed to steps after ⑦.
 - b) If the comment is "This file is same version." or "This file is old version."
⇒ It is not necessary to update the software since the software already installed in this instrument has the same version of the software saved in USB memory or newer version. Press CLEAR key to exit the menu.

- ⑦ Press the function key so that Software version for update is selected (e.g., press F2 key on the diagram on the previous page).
- ⑧ Press F6 key to select SELECT (on the left in the diagram below).
The software of this instrument to be updated is displayed in File List (on the right in the diagram below).

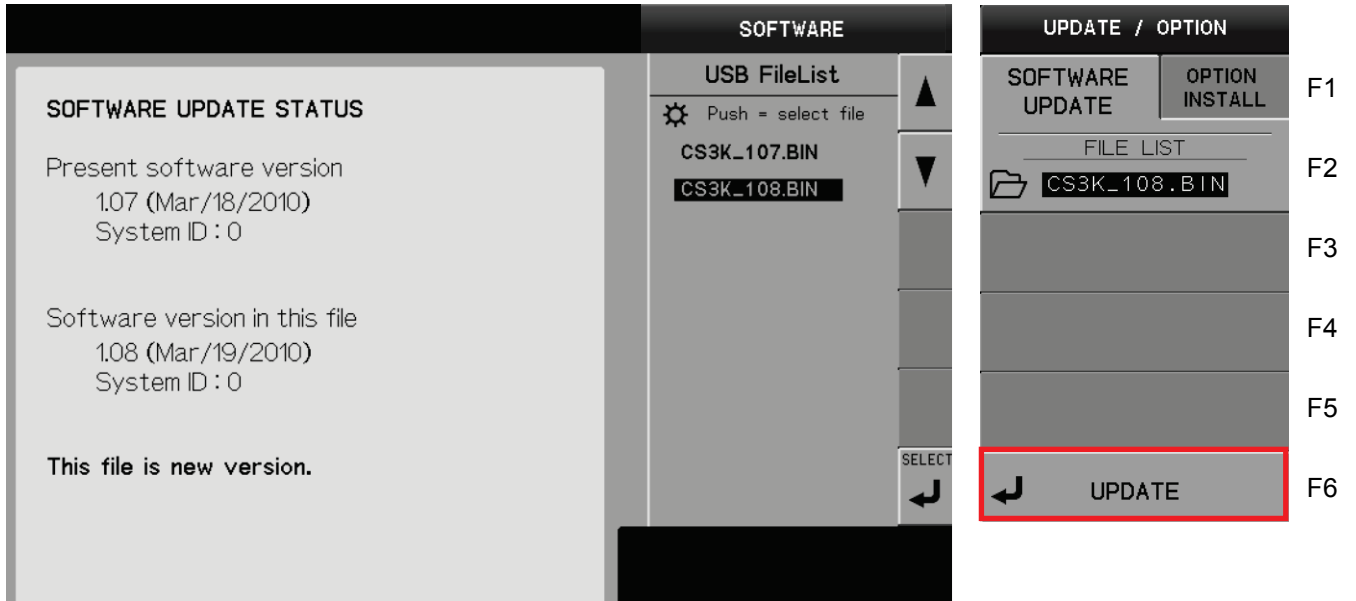

- ⑨ Press F6 key to select UPDATE. CONFIRMATION screen appears as shown below.
Select [OK] to execute update.
Select [CANCEL] to display SYSTEM TOOLS submenu without execution of update.

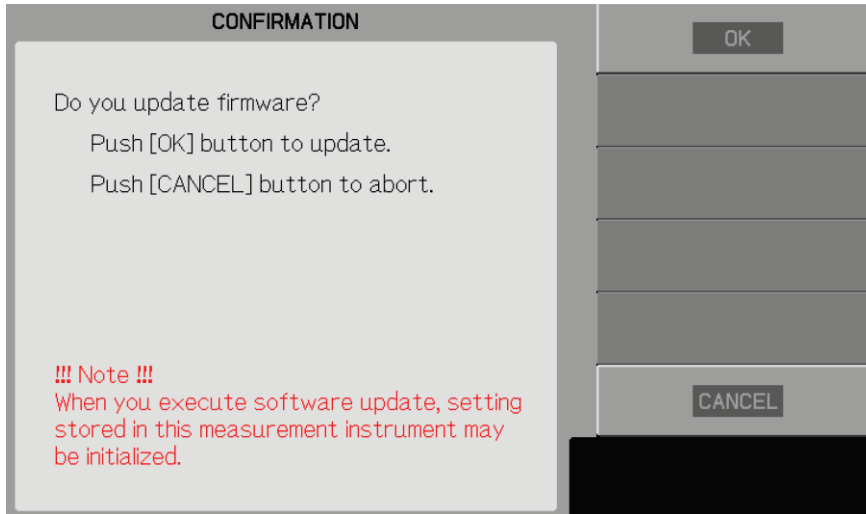

Note 1: When updating the software in the instrument, never set the power supply to standby or remove the USB memory.

Note 2: Updating the software in the instrument causes all the internal settings to be initialized. Necessary data of SETUP (setting conditions), TRACE (waveform data), and REF (reference waveform data) should be saved in the USB memory using SAVE function (see Sections 3.11.3 and 3.11.4) in SAVE/RECALL menu. For initialized items, see the default setting items in "Table 3.11.1: Recall function" and "Table 3.11.2 Not recall function" of Section 3.11.8.

After several minutes, update is completed and the screen below appears to indicate successful update.

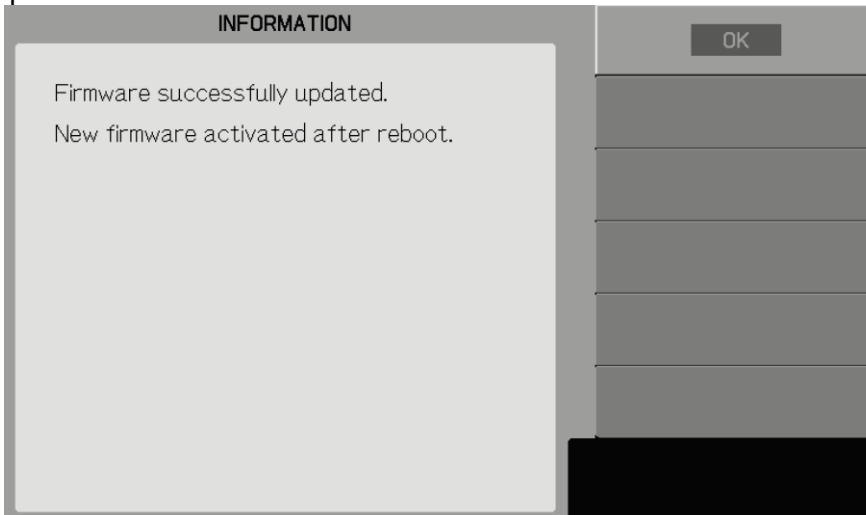

- ⑩ Restart the instrument using ON/Standby switch.
- ⑪ When reactivating, the screen like the figure below (left) might be displayed and internal hardware be renewed. The update ends at about five seconds. When the update is completed, the figure below (right) is displayed.

The update is being executed.



After completing the update

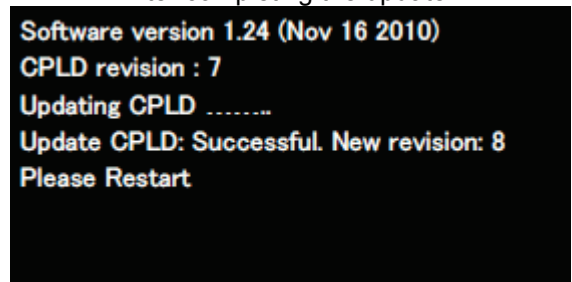

*The Version number and the Revision number in figure are one example.

Caution) please never make the power supply a standby while updating the internal hardware in the instrument.

- ⑫ After restart, press UTILITIES key, F5 key, and F1 key to confirm the normally updated version No. (as shown below) on SYSTEM STATUS screen.



3.11.1.8 Installation of optional software

Use of SYSTEM TOOLS submenu allows the optional software of this instrument to be installed. To install the optional software, in some cases, it may be necessary to update the software in the instrument

Follow Section 3.11.1.6.

When installing the optional software, attention should be paid to caution below:

Caution !

- 1) When installing the optional software, never set the power supply to standby or remove the USB memory.

When installing the software, follow [Procedure].

[Procedure] Installation of optional software

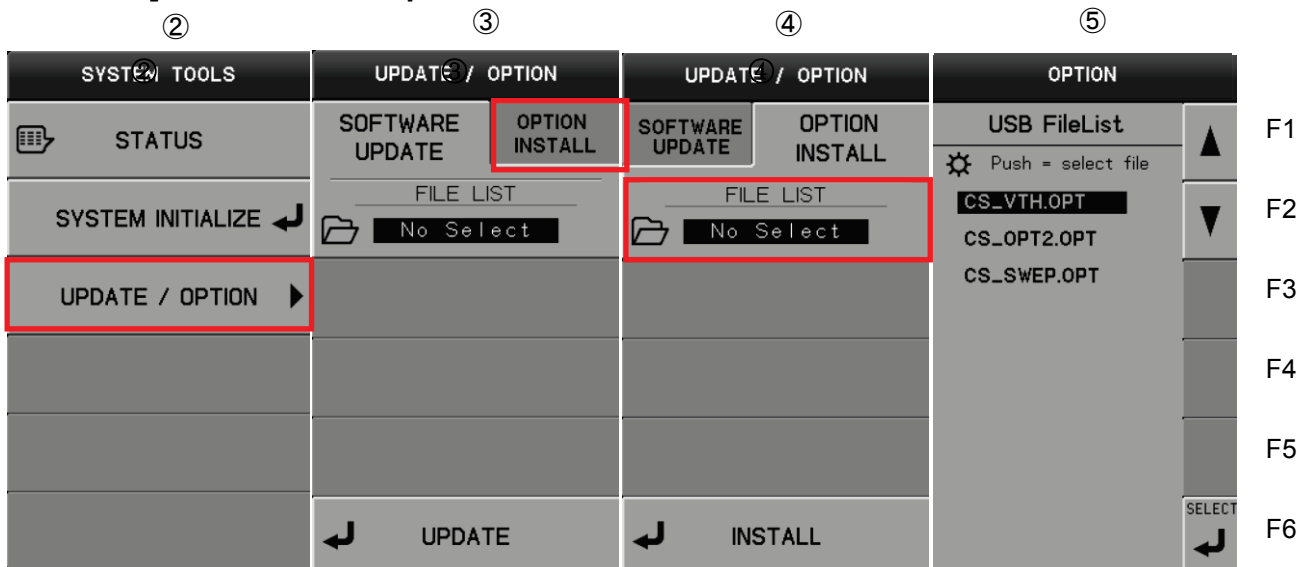

- ① Connect the USB memory saving the optional software.
"USB memory available" appears on the upper side in the screen.
- ② Press UTILITIES key to open SYSTEM TOOLS menu shown in diagram ②.
- ③ Press F3 key to display UPDATE/OPTION submenu shown in diagram ③.
- ④ Press F1 key to display OPTION INSTALL tab shown in diagram ④.
- ⑤ Press F2 key to display USB FileList shown in diagram ⑤.

The optional file in OPT folder is displayed in USB FileList.
Simultaneously, the relationship between the file including the cursor in the submenu and the current optional file of this instrument is displayed as shown in OPTION INSTALL STATUS screen.

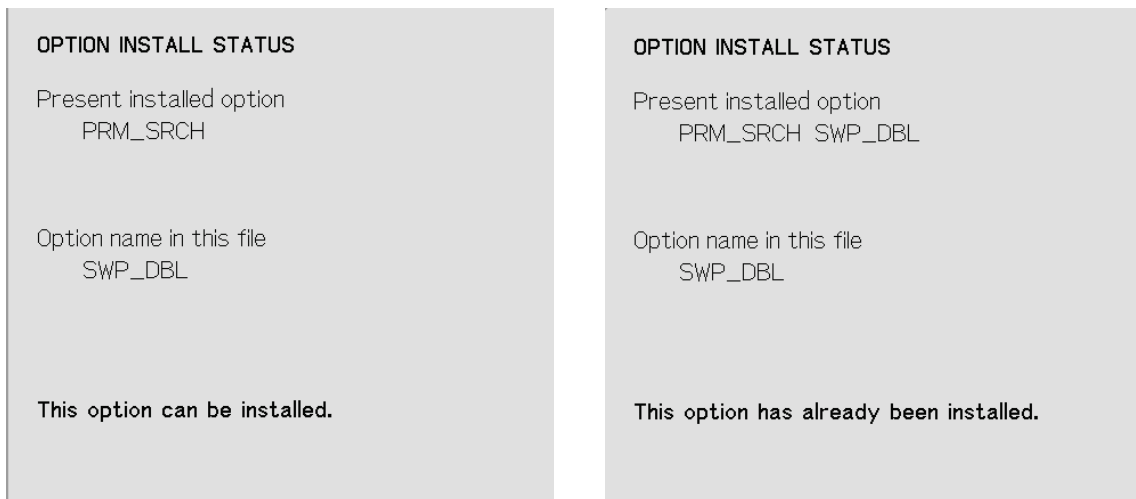

2nd and 3rd lines in the diagram above indicate the current installation status of the optional software of this instrument and 4th and 5th lines indicate the name of options saved in the USB memory. The left side of the diagram above shows that SWP_OPT has not been installed yet and the optional file in USB memory can be installed. The right side of the diagram above shows that SWP_DBL has already been installed, and that it is not necessary to install the option file that exists in the USB memory. If the error message appears as shown on 4th and 5th lines of the lower side, refer to "5. Error Messages".

- ⑥ Press F1 or F2 to select the optional file to be installed.

- ⑦ Press F6 key to select SELECT (on the left of diagram below).
The optional file to be installed is displayed in File List (on the right of diagram below).

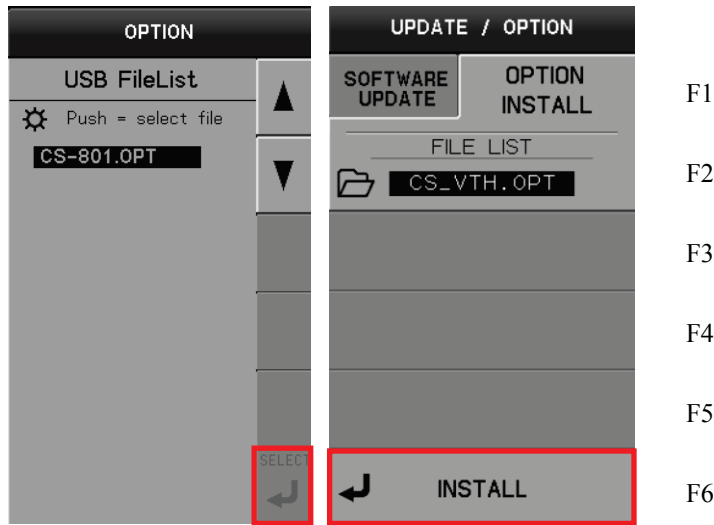

- ⑧ Press F6 key to select INSTALL. Installation starts.

Note: When installing the optional file, never set the power supply to standby or remove the USB memory.

After several seconds, INFORMATION screen is displayed as shown below and installation finishes.

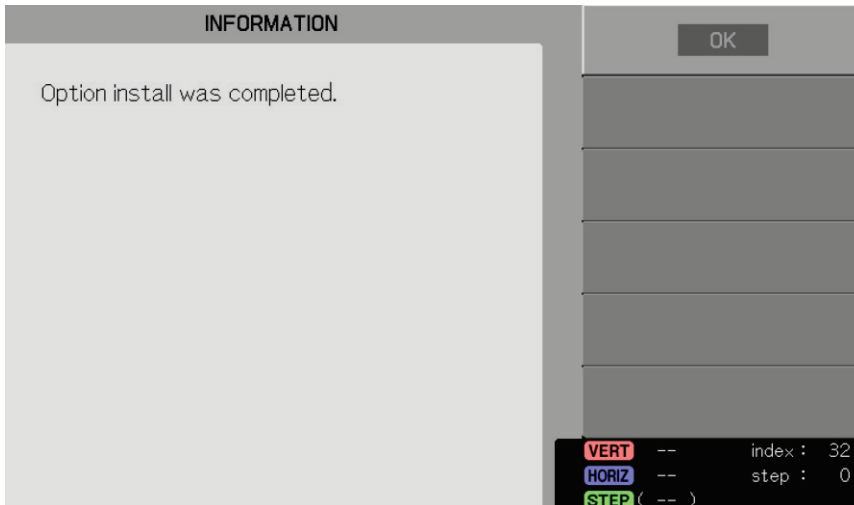

- ⑨ Restart this instrument using Power On/Standby switch.
- ⑩ After restart, press UTILITIES key, F5 key, and F1 key to confirm the normally installed option (items of Installed option) on SYSTEM STATUS screen.

■ If message "This option has already been installed." appears on lower side of screen

The message may appear on OPTION INSTALL STATUS screen as shown on the right. **This indicates that the corresponding option is already installed in the instrument.**

Since the option saved in USB memory can be used, it is not necessary to install it. Remove USB memory.

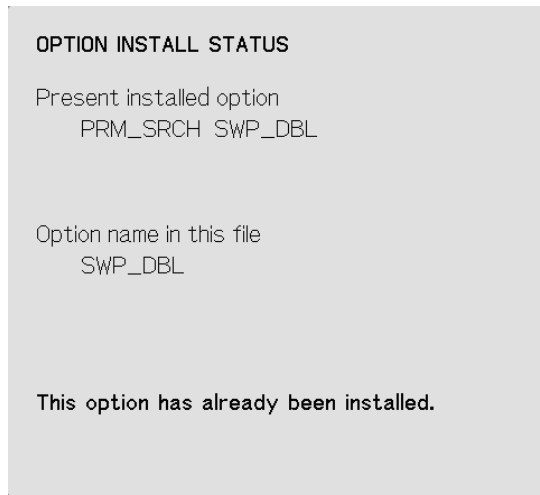

■ If error message "This file cannot be installed in this machine." appears on lower side of screen

When the error message appears in OPTION INSTALL STATUS screen as shown on the right, possible causes are:

- **Product ID of the optional file saved in USB memory is different from that of this instrument.**
- **The optional file saved in USB memory is not correct.**

<Action method>

- ① Check Product ID to confirm if the option is correct to the instrument in which the option is to be installed. If a wrong USB is inserted, use USB memory consistent with Product ID of this instrument.
- ② Execute [Procedure] of installation again. If the error message appears again, contact Iwatsu office or our sales distribution.



3.11.2 COPY key

Pressing COPY key ② below allows hard copy to execute.

- Hard copy is executed with the settings being set on submenu "HARD COPY" of "UTILITY."
- * See the submenu "3.11.1.2 HARD COPY."
- File is created in the COPY folder in the USB memory.
- Each time hard copy is executed, 4-digit number on the right in the file name increases one by one. (Note that when reaching 9999, the number is overwritten without addition.)
- Messages below are displayed on the upper part on the screen:

When USB memory is mounted: "USB memory available."

When hard copy is executed: "Creating save data" and then
"Display hardcopy dumped to \$filename\$."

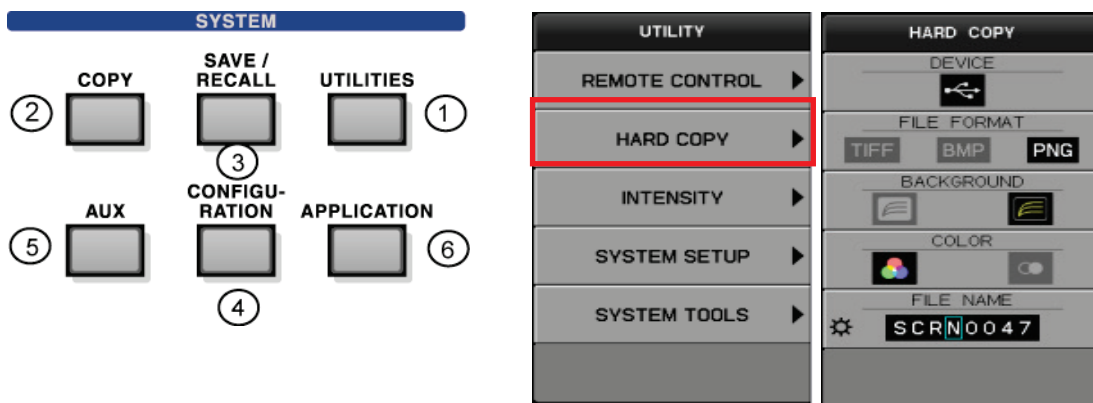

3.11.3 SAVE/RECALL key

Pressing SAVE/RECALL key ③ allows SAVE/RECALL/DELETE menu to appear.

3.11.3.1 SAVE submenu

3.11.3.2 RECALL submenu

3.11.3.3 DELETE submenu

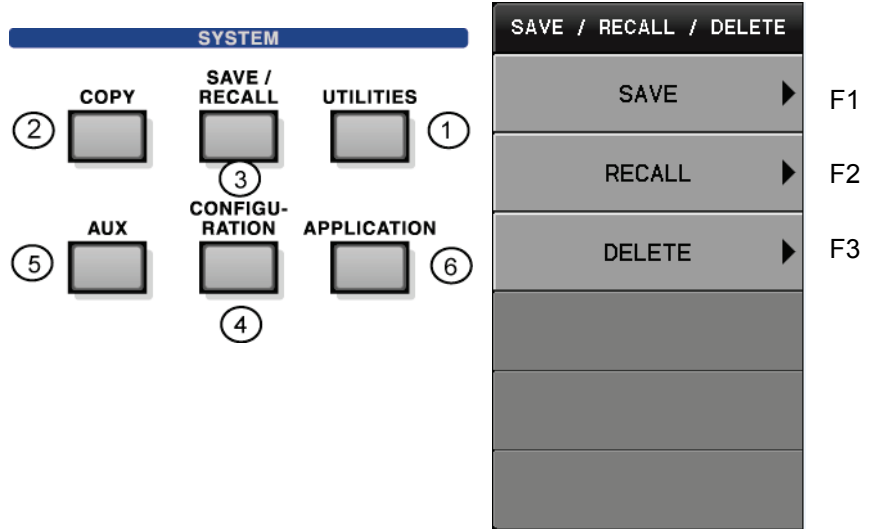

Relationship between SAVE/RECALL key and SAVE REF of DISPLAY-MENU key

SAVE REF of DISPLAY-MENU key is used to save the characteristic curve being measured currently in the internal memories (#1 to #4).

On the other hand, SAVE of SAVE/RECALL key saves data of the internal memories (#1 to #4) in the USB memory after attaching the file name.

RECALL is used to recall the file selected by File List of the USB memory into the internal memories (#1 to #4).

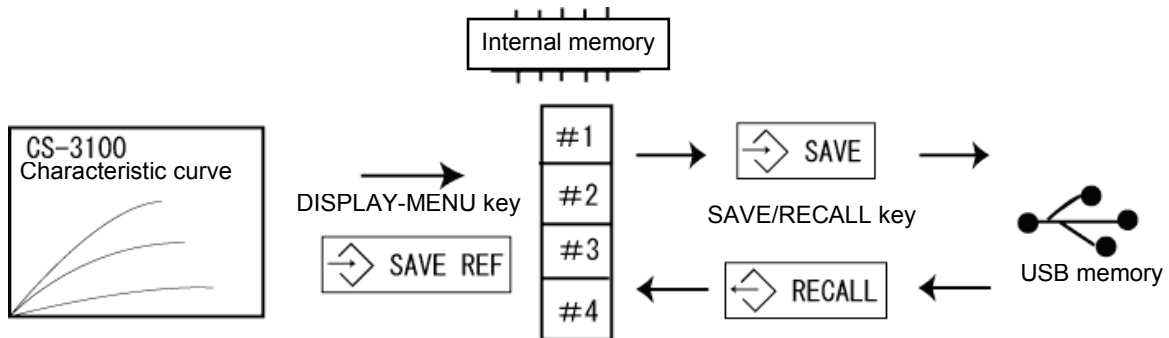

3.11.3.1 SAVE submenu

Pressing F1 key allows the submenu "SAVE" to appear.

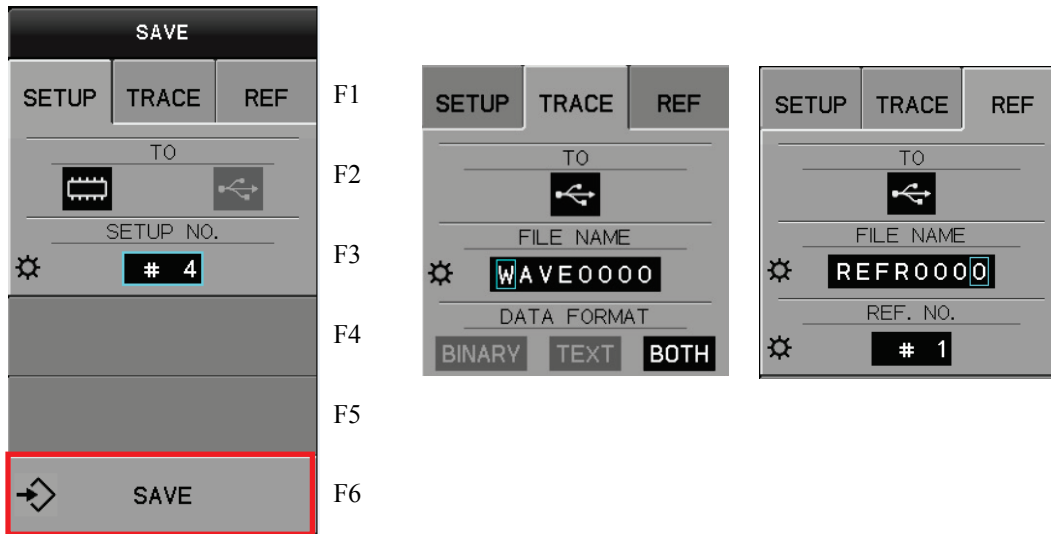

Pressing F6 key on the right of the submenu "SAVE" allows saving to execute.

- Each time data is saved into the USB memory, 4-digit number on the right in the file name increases one by one. (Note that when reaching 9999, the number is not increased.)
- Folders and extensions below are used depending on where to save.
 - SETUP : ¥SETUP¥*.SET
 - TRACE : ¥WAVE¥*.WFM: binary format
¥WAVE¥*.CSV: text format
 - REF : ¥REF¥*.REF
- If there is the file with the same file name when saving the file, the confirmation screen to overwrite is displayed.
- Pressing OK key allows the file to be overwritten.

Submenus and functions

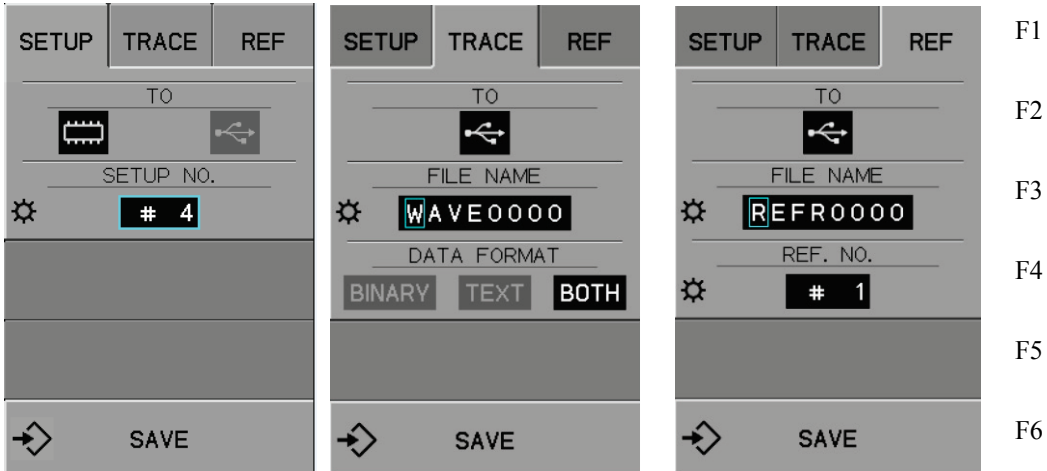

For SETUP

NO.	Submenus	Function description
F1	SETUP	Selects data to be saved.
F2	TO	Selects the storage media: internal memory/USB memory.
F3	SETUP NO.	For the internal memory, sets 1 to 256. For the USB memory, sets the file name.
F4, F5		(Not used)
F6	SAVE	Executes the save.

For TRACE, REF

NO.	Submenus	Function description
F1	TRACE/REF	TRACE (measurement waveform) REF (REF waveform, internal waveform saving)
F2	TO.	Media is fixed to USB memory *1
F3	FILE NAME	Sets the file name.
F4	DATA FORMAT REF. NO.	DATA FORMAT: Selects data format from BINARY/ TEXT/ BOTH. BOTH saves both of binary and text files. * TEXT format cannot be recalled. REF. NO.: Sets the number of REF waveform to be saved: 1 to 4.
F5		(Not used)
F6	SAVE	Executes the saving.

*1: For saving REF waveform in the internal memory, see "SAVE REF" of MENU key in Section 3.10.1.

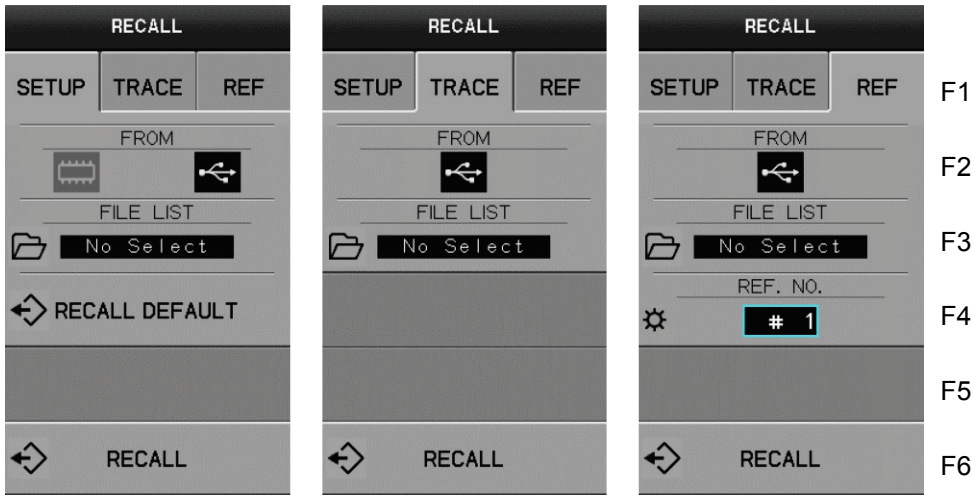

3.11.3.2 RECALL submenu

Pressing F5 key allows the submenu "RECALL" to appear.



Submenus and functions

For SETUP (Refer to the table of next page for TRACE/REF.)

F1	Submenus	Function description
F1	SETUP/TRACE /REF	Selects the data to be recalled (SETUP, TRACE, REF).
F2	FROM	Selects the media to be used to recall.  Internal memory  USB memory
F3	SETUP NO. FILE LIST	For internal memory, sets 1 to 256. For USB memory, the file list is displayed for selection.
F4	RECALL DEFAULT	Recalls default setup.*1
F5		(Not used)
F6	RECALL	Execute Recall.

*1: For detailed DEFAULT settings, see "Table 3.11.1 Settings to be recalled" in Section 3.11.8.

- Pressing F6 key on the right of the submenu "RECALL" allows the specified file to be recalled.
- Pressing F4 key on the right of the submenu "RECALL DEFAULT" allows the default settings to be recalled.

Caution!

- ◆ Execution of RECALL causes the voltage being set by VARIABLE % to be applied to a measured device. Care should be taken.

- For SETUP, SETUP settings of the file selected before decision is displayed in the waveform display area.

Ex.:

CONFIG		BSGEN
MEASURE	Status	STOP
COLLECTOR	Variable	21.4 %
	HC/HV	HV
	Mode	-DC
	MaxPeakVolts	30V
	MaxPeakPower	120W
STEP GENERATOR	Range	-5uA
	Offset	-13.60uA
	num of steps	0 steps
	Mode	PULSE
VERTICAL	Range	COLLECTOR, 500 uA/div
HORIZONTAL	Range	COLLECTOR, 1.00 V/div
DATE & TIME		2010/03/24 15:41:49
COMMENT		CURVE TRACE

For TRACE, REF

NO.	Submenus	Function description	
F1	SETUP/TRACE	Selects the data to be recalled.	
	/REF	TRACE (measurement waveform)	REF (REF waveform, internal waveform saving)
F2	FROM	Media including data is fixed to USB memory.	
F3	FILE LIST	Displays the file list for selection.	
F4	Not used/REF. NO.	Sets REF waveform number to recall: 1 to 4.	
F5	(Not used)		
F6	RECALL	Executes RECALL.	

Procedure to select the file list

- (1) Press F3 key on the right of submenu "FILE LIST" to display only objective file (with the specified extension) in the objective folder in the USB memory (see example below).

SETUP information appears in the waveform display area.

Press F1 key/ rotate FUNCTION knob counterclockwise Upper file selected ↑

Press F2 key/ rotate FUNCTION knob clockwise Lower file selected ↓

Select the file by rotating FUNCTION knob or press F1 (↑)/F2 (↓) key.

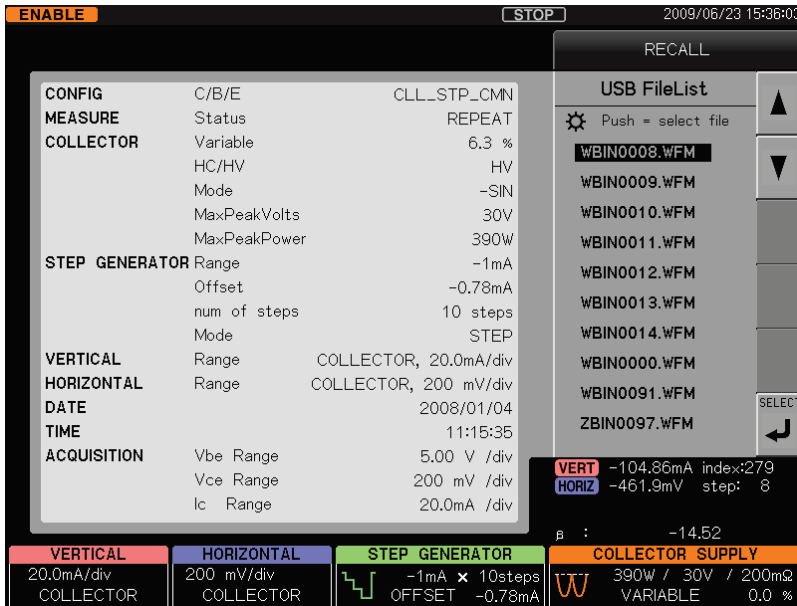

- (2) Press F6 key on the right of the submenu "SELECT."
You return to the previous menu. The screen displays the file number selected in the submenu "FILE LIST".
- (3) Press F6 key on the right of the submenu "RECALL."
The selected SETUP/TRACE/REF data is recalled and at the same time, "RECALL" menu disappears.

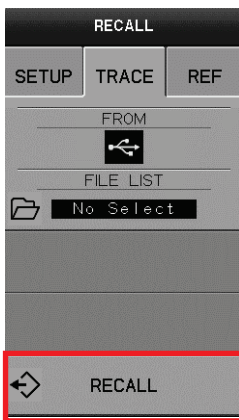

3.11.3.3 3.11.3.3 DELETE submenu

Pressing F5 key allows the submenu "DELETE" to appear.

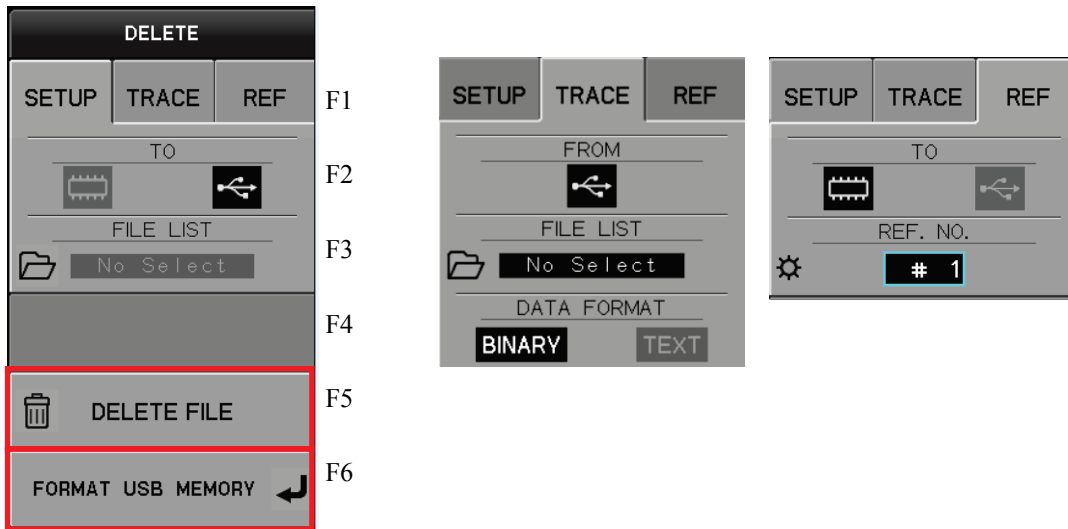

Submenus and functions

Submenu		Function description		
F1	SETUP/TRACE /REF	Selects the data to be deleted.		
		SETUP	TRACE	REF
F2	FROM	Selects data to be deleted. Internal memory/ USB memory	Fixed to USB memory	Selects data to be deleted. Internal memory/ USB memory
F3	SETUP NO (Internal memory)	For internal memory, sets 1 to 256.	/	For internal memory, sets 1 to 4.
	FILE LIST (USB memory)	For USB memory, displays the file list for selection.		Displays the file list for selection.
F4	DATA FORMAT	(Not used)	Selects BINARY/TEXT.	(Not used)
F5	DELETE FILE	Executes DELETE.		
F6	FORMAT USB MEMORY	Executes formatting USB memory.		

Procedure for DELETE FILE

- (1) Press F5 key on the right of the submenu "DELETE FILE" to delete the specified file.
- (2) Press F6 on the right of the submenu "FORMAT USB MEMORY" to display the confirmation screen to format the USB memory.
- (3) Press OK key to format the memory.

Caution: If the memory is formatted, all saved data is deleted. Before execution of formatting, check that the memory to be formatted includes no important data.

3.11.4 Setting of SAVE/RECALL/DELETE (saving/recalling/deleting data)

This section explains procedures for SAVE/RECALL/DELETE for each data type, and internal memory/USB memory.



★ 1. Data type

Data types to be handled by SAVE/RECALL menu are as follows:

- SETUP: Setting condition data
- TRACE: Setting condition data and characteristic curve data
- REF: REF characteristic curve data

★ 2. Internal memory/USB memory

Setting for SAVE uses the submenu [TO] and setting for RECALL and DELETE uses the submenu [FROM].

- Internal memory in this instrument 
- USB memory 

★ 3. File name (when saving into USB memory)

- File name (Ex.: ABCD1234) consists of 8 characters; the first 4 alphabet characters (Alphanumeric character of normal-width capital letter;!#\$%&'()-@^_{}~) and 4 numeric 8-bit characters following them.
- When saved into the USB memory, data is saved with the specified file name in the SETUP, WAVE, or REF folder. If folder above does not exist, the folder is automatically created.

[Procedure]

- (1) Each time data is saved into the USB memory, 4-digit number on the right in the file name increases one by one. (Note that when reaching 9999, the number is not increased.)
- (2) The folders and extensions below are used for each type of data being saved.
 - a) SETUP ¥SETUP¥*.SET
 - b) TRACE ¥WAVE¥*.WFM: binary format
 ¥WAVE¥*.CSV: text format
 - c) REF ¥REF¥*.REF
- (3) If there is the file with the same file name when saving the file, the confirmation screen to overwrite is displayed.
- (4) Pressing OK key allows the file to be overwritten.

Caution!

- ◆ Execution of RECALL causes the voltage being set by VARIABLE % to be applied to a measured device. Care should be taken.

3.11.4.1 Saving SETUP, TRACE, or REF data

[Procedure 1] Saving SETUP data into Internal Memory

- (1) Press SAVE/RECALL key. SAVE/RECALL/DELETE menu appears.
- (2) Press F1 key on the right of the submenu "SAVE."
- (3) Press F1 key on the right of the submenu "SETUP/TRACE/REF" and select "SETUP".
- (4) Press F2 key on the right of the submenu "TO" and select the internal memory icon .
- (5) The submenu changes to "SETUP NO." and the number is enclosed by the blue frame. SETUP number can be set.
- (6) Rotate FUNCTION knob to set the number (1 to 256).
- (7) Press F6 key on the right of the submenu "SAVE."



When being saved, "Save SETUP to #xx" (xx=SETUP NO) is displayed in the message area on the upper part on the screen. Each time being saved, SETUP number increases one by one.

[Procedure 2] Saving TRACE data into USB memory

- (1) Press SAVE/RECALL key. SAVE/RECALL/DELETE menu appears.
- (2) Press F1 key on the right of the submenu "SAVE."
- (3) Press F1 key on the right of the submenu "SETUP/TRACE/REF" and select "TRACE."

F3 submenu changes to "FILE NAME" and the 1st digit of the file name is enclosed by the blue frame.
- (4) Rotate FUNCTION knob to register the file name consisting of 8 characters; the first 4 alphabet characters (8-bit and uppercase;!#\$%&'()-@^_{}~) and 4 numeric 8-bit characters following them.
- (5) Press F4 key on the right of the submenu "DATA FORMAT" and select "BINARY" or "TEXT."

Text data cannot be recalled.
- (6) Press F6 key on the right of the submenu "SAVE."

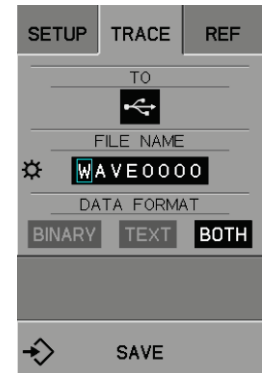

To transfer between figures, press FUNCTION knob or F3 key.

When being saved, "Save SETUP to ABCD0001.WFM" or "Save SETUP to ABCD0001.CSV" is displayed in the message area of the upper part in the screen.

Each time being saved, FILE NAME number increases one by one.

If there is the file with the same file name when saving the file, the confirmation screen to overwrite is displayed.

Ex.: CONFIRMATION

File "ABCD0001.WFM" already exists. Do you overwrite? Push [OK] button to overwrite. Push [CANCEL] button to abort.

Press [OK] key to overwrite the file. Press [CANCEL] key to abort.

[Procedure 3] Saving REF data into USB memory

- (1) Press SAVE/RECALL key. SAVE/RECALL/DELETE menu appears.
- (2) Press F1 key on the right of the submenu "SAVE."
- (3) Press F1 key on the right of the submenu "SETUP/TRACE/REF" and select "REF."
F3 submenu changes to "FILE NAME" and the 1st digit of the file name is enclosed by the blue frame.
- (4) Rotate FUNCTION knob to register the file name consisting of 8 characters; the first 4 alphabet characters (8-bit and uppercase;!#\$%&'()-@^_{}~) and 4 numeric 8-bit characters following them.
- (5) Press F4 on the right of the submenu "REF. NO." and select "#1 to #4."
Press F6 key on the right of the submenu "SAVE."



- (6) When being saved, "Save SETUP to ABCD0001.REF" is displayed in the message area of the upper part in the screen.
Each time being saved, FILE NAME number increases one by one.
If there is the file with the same file name when saving the file, the confirmation screen to overwrite is displayed.
Ex.: CONFIRMATION
File "ABCD0001.REF" already exists. Do you want to overwrite? Push [OK] button to overwrite.
Push [CANCEL] button to abort.

3.11.4.2 Recalling SETUP, TRACE, or REF data

[Procedure 1] Recalling SETUP data from internal memory

- (1) Press SAVE/RECALL key. SAVE/RECALL/DELETE menu appears.
- (2) Press F2 key on the right of the submenu "RECALL"
- (3) Press F1 key on the right of the submenu "SETUP/TRACE/REF" and select "SETUP."
- (4) Press F2 key on the right of the submenu "FROM" and select the internal memory icon. 
- (5) F3 submenu changes to "SETUP NO." and the number is enclosed by the blue frame. SETUP number can be set.
- (6) Rotate FUNCTION knob to set the number (1 to 256).
SETUP information is displayed in the waveform display area.
- (7) Press F6 key on the right of the submenu "RECALL" and execute "RECALL."



- (8) When being recalled, "Recall SETUP from #xx" (xx=SETUP NO) is displayed in the message area on the upper part on the screen.

Executing "RECALL DEFAULT"

[Procedure 2]

- (1) Press SAVE/RECALL key. SAVE/RECALL/DELETE menu appears.
- (2) Press F2 key on the right of the submenu "RECALL."
- (3) Press F4 key on the right of the submenu "RECALL DEFAULT."
SETUP (setting conditions) is set to defaults.

For detailed DEFAULT settings, see "Table 3.11.1 Recall functions" in Section 3.11.8 "Default settings."

[Procedure 3] Recalling TRACE data from USB memory to screen

- (1) Press SAVE/RECALL key. SAVE/RECALL/DELETE menu appears.
- (2) Press F2 key on the right of the submenu "RECALL."
- (3) Press F1 key on the right of the submenu "SETUP/TRACE/REF" and select "TRACE."
- (4) Press F3 key on the right of the submenu "FILE LIST."
SETUP information is displayed in the submenu "USB File list" and the waveform display area.
- (5) Rotate FUNCTION knob or press F1(↑)/F2(↓) key to select the file.
- (6) Press F6 key on the right of the submenu "SELECT."
The selected file name is displayed in the submenu "FILE LIST."
- (7) Press F6 key on the right of the submenu "RECALL" and execute "RECALL."
- (8) "Recall from ABCD0001.WFM" is displayed in the message area on the upper part of the screen and TRACE waveform is displayed in the waveform display area.
At the same time, the menu screen disappears.

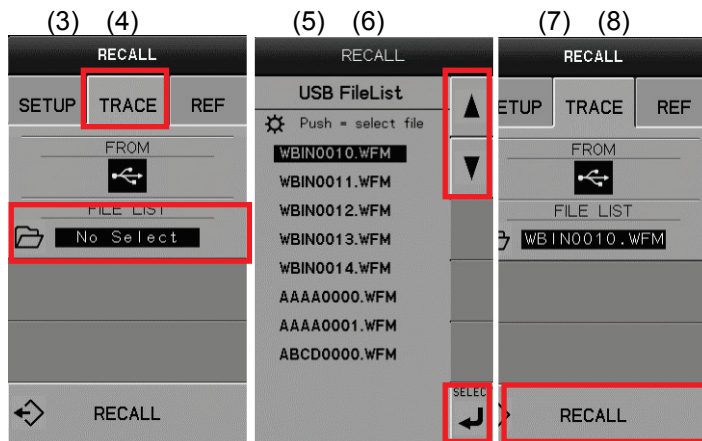

[Procedure 4] Recalling REF data from USB memory into internal memory

- (1) Press SAVE/RECALL key. SAVE/RECALL/DELETE menu appears.
- (2) Press F2 key on the right of the submenu "RECALL."
- (3) Press F1 key on the right of the submenu "SETUP/TRACE/REF" and select "REF."
- (4) Press F3 key on the right of the submenu "FILE LIST."
The file name is displayed in the submenu "USB File list."
- (5) Rotate FUNCTION knob or press F1(↑)/F2(↓) key to select the file.
- (6) Press F6 key on the right of the submenu "SELECT."
The selected file name is displayed in the submenu "FILE LIST."
- (7) Press F6 key on the right of the submenu "RECALL" and execute "RECALL."
"Recall from ABCD0001.REF" is displayed in the message area on the upper part of the screen and REF waveform is displayed in the waveform display area.
"Recall from ABCD0001.REF" appears in the message area on the upper side of the screen.

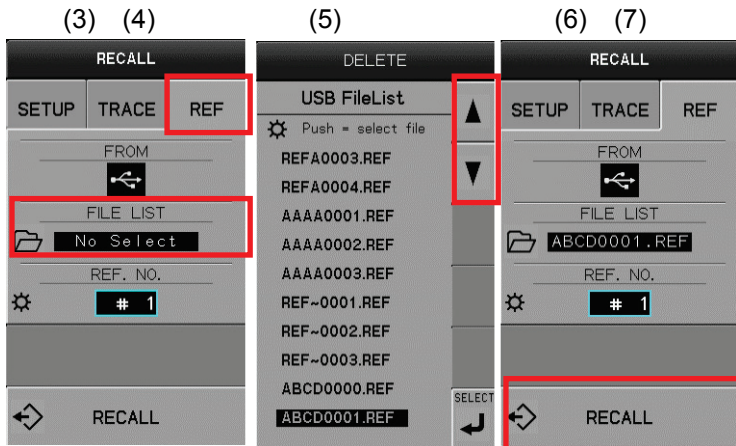

3.11.4.3 Deleting SETUP, TRACE, REF data

[Procedure 1] Deleting SETUP data from internal memory

- (1) Press SAVE/RECALL key. SAVE/RECALL/DELETE menu is displayed.
 - (2) Press F3 key on the right of the submenu "DELETE."
 - (3) Press F1 key on the right of the submenu "SETUP/TRACE/REF" and select "SETUP."
 - (4) Press F2 key on the right of the submenu "FROM" and select the internal memory icon. 
- F3 submenu changes to "SETUP NO." and the number is enclosed by the blue frame. SETUP number can be set.



- (5) Rotate FUNCTION knob to set the number (1 to 256).
SETUP information is displayed in the waveform display area.
- (6) Press F5 key on the right of the submenu "DELETE FILE" and execute "DELETE."
"Delete #xx"(xx=SETUP NO) is displayed in the message area on the upper part on the delete screen.

[Procedure 2] Deleting TRACE data from USB memory

- (1) Press SAVE/RECALL key. SAVE/RECALL/DELETE menu appears.
- (2) Press F3 key on the right of the submenu "DELETE."
- (3) Press F1 key on the right of the submenu "SETUP/TRACE/REF" and select "TRACE."
- (4) Press F4 key on the right of the submenu "BINARY, TEXT" and select "BINARY/TEXT."
- (5) Press F3 key on the right of the submenu "FILE LIST."
SETUP information is displayed in the submenu "USB File list" and the waveform display area.
- (6) Rotate FUNCTION knob or press F1(↑)/F2(↓) key to select the file.
- (7) Press F6 key on the right of the submenu "SELECT".
- (8) The selected file name is displayed in the submenu "FILE LIST."
- (9) Press F5 key on the right of the submenu "DELETE" and execute "DELETE."
"Delete ABCD0001.WFM" is displayed in the message area on the upper part of the screen.

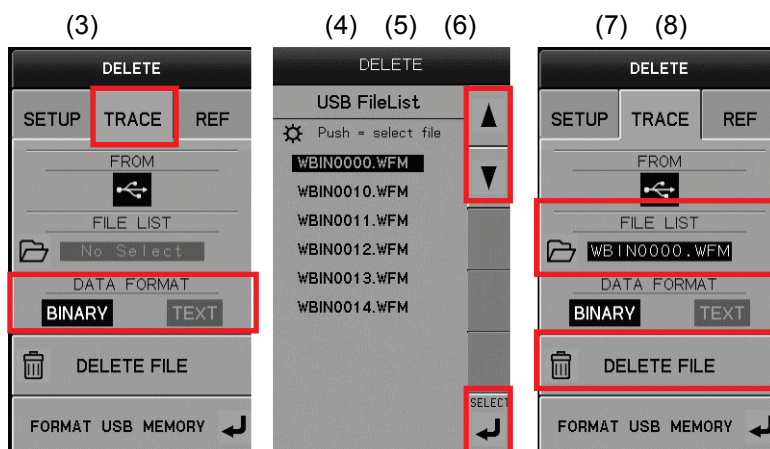

[Procedure 3] Deleting REF data from USB memory

- (1) Press SAVE/RECALL key. SAVE/RECALL/DELETE menu appears.
- (2) Press F3 key on the right of the submenu "DELETE."
- (3) Press F1 key on the right of the submenu "SETUP/TRACE/REF" and select "REF."
- (4) Select USB memory icon  on the right of the submenu "FROM."
- (5) Press F3 key on the right of the submenu "FILE LIST."
The submenu "USB File list" displays the file to be deleted.
- (6) Rotate FUNCTION knob or press F1(↑)/F2(↓) key to select the file to be deleted.
- (7) Press F6 key on the right of the submenu "SELECT."
- (8) The submenu "FILE LIST" displays the selected file for deletion.
- (9) Press F5 key on the right of the submenu "DELETE" and execute "DELETE."
"Delete ABCD0001.REF" is displayed in the message area on the upper part of the screen.

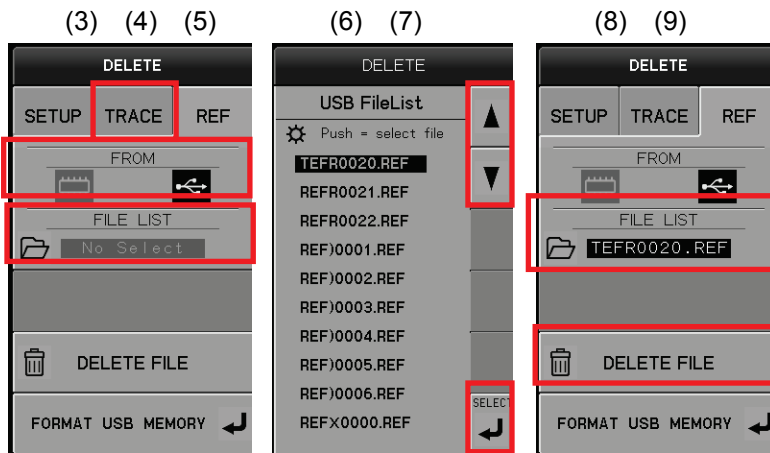

[Procedure 4] Deleting REF data from internal memory

- (1) Press SAVE/RECALL key. SAVE/RECALL/DELETE menu appears.
- (2) Press F3 key on the right of the submenu "DELETE."
- (3) Press F1 key on the right of the submenu "SETUP/TRACE/REF" and select "REF."
- (4) Press F2 key on the right of the submenu "FROM" and select the internal memory icon. 
F3 submenu changes to "REF NO." and the number is enclosed by the blue frame.
- (5) Rotate FUNCTION knob to set the number (1 to 4).
- (6) Press F5 key on the right of the submenu "DELETE FILE" and execute "DELETE."
"Delete Ref #1" is displayed in the message area on the delete screen.



Executing "FORMAT USB MEMORY"

[Procedure 5]

- (1) Press SAVE/RECALL key. SAVE/RECALL/DELETE menu appears.
- (2) Press F3 key on the right of the submenu "DELETE."
- (3) Press F6 key on the right of the submenu "FORMAT USB MEMORY."
The confirmation screen for format is displayed.

CONFIRMATION

Do you format USB memory? Push [OK] button to format. Push [CANCEL] button to abort.
Press [OK] key to execute format. Press [CANCEL] key to abort.

Caution! Handling USB memory

1): When saving/recalling into/from USB memory

Connect the USB memory to the USB terminal at the lower left part of the front panel.
Note that even if the USB memory is not connected, "USB Memory" can be selected.
Connect the USB memory before executing the submenu "Save" or "Recall."

2): When mounting USB memory

Message "USB memory available" in white characters appears on the menu screen.

3): OK? when USB memory is removed.

For the USB memory to be mounted on this instrument, it does not require any operation for safety or protection which is generally required when the memory is removed from the computer. However, the USB memory must not be removed during access to it; i.e., installation of software (firmware and option), saving, and recalling.

4): Suitable USB memory

USB memories being formatted by FAT or FAT32 are available.
This instrument does not support USB memories formatted by NTFS
For USB memories with security functions, they must be used after disabling the functions.

3.11.5 CONFIGURATION key

CONFIGURATION key sets connection between the collector/base/emitter terminals and the COLLECTOR SUPPLY, STEP GENERATOR or Common.
 Change to CONFIGURATION settings initializes VARIABLE setting values (see Section 3.7.1.2).
 Pressing CONFIGURATION key ④ allows "CONFIGURATION" menu to appear.

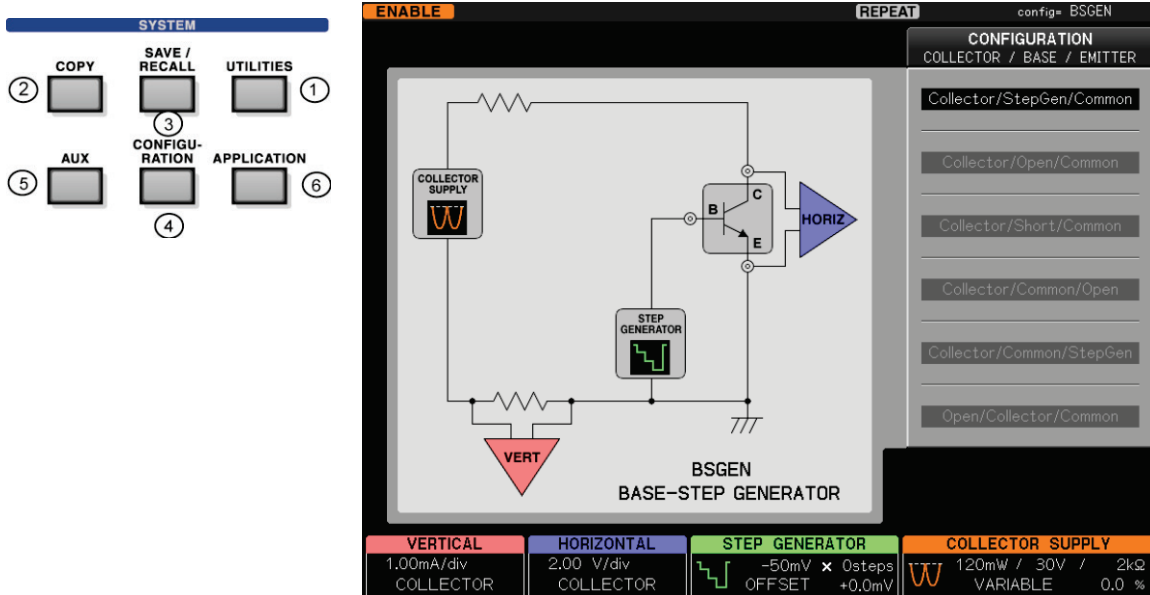

Pressing function keys (F1 to F6) allows the internal connection state to change as shown below:
 The comment on the connection status is displayed on the lower-right side of the internal connection diagram.

	Internal connection diagram	Destination of measured device C/B/E
F1	<p>BSGEN BASE-STEP GENERATOR</p>	<p>C: Collector Supply B: Step Generator E: Common</p>
F2	<p>BOPEN BASE-OPEN</p>	<p>C: Collector Supply B: Open E: Common</p>

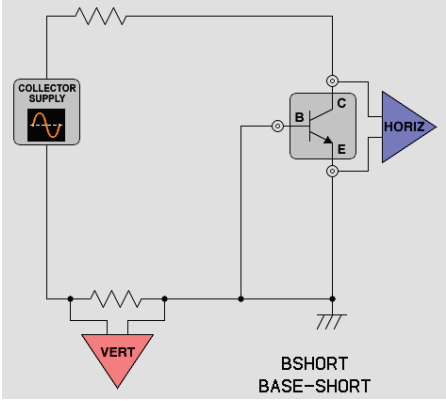
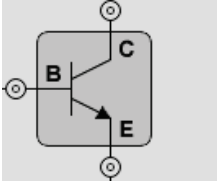
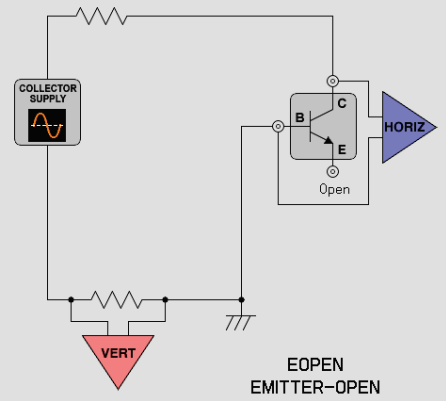
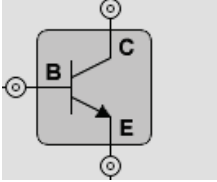
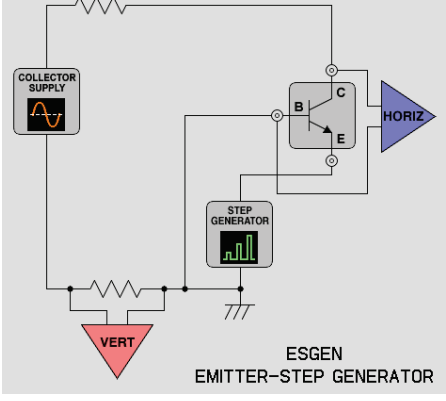
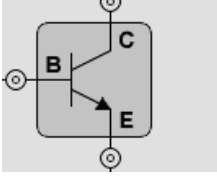
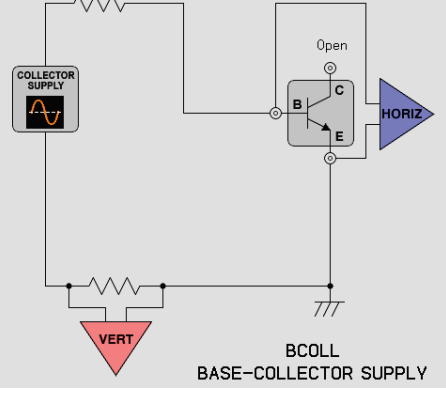
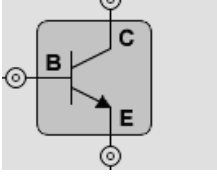
	Internal connection diagram	Destination of measured device C/B/E
F3	 <p>BSHORT BASE-SHORT</p>	 <p>C: Collector Supply B: Short (Common) E: Common</p>
F4	 <p>EOPEN EMITTER-OPEN</p>	 <p>C: Collector Supply B: Common E: Open</p>
F5	 <p>EGEN EMITTER-STEP GENERATOR</p>	 <p>C: Collector Supply B: Common E: Step Generator</p>
F6-1 (*)	 <p>BCOLL BASE-COLLECTOR SUPPLY</p>	 <p>C: Open B: Collector Supply E: Common For Open/Collector/Common, MAX PEAK VOLTAGE cannot be set to 5kV.</p>

F6-2
(*)

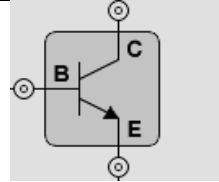
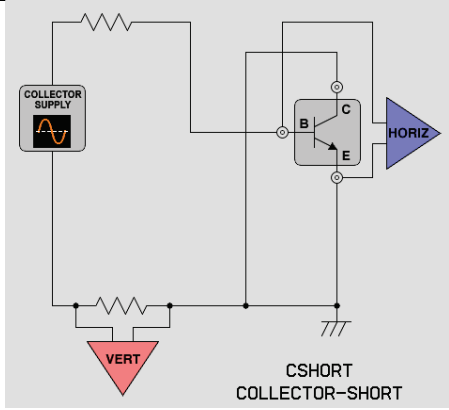

C: Short
 B: Collector Supply
 E: Common
 For Short/Collector/Common MAX PEAK VOLTAGE cannot be set to 5kV.

* State (Open / Short) of the terminal COLLECTOR is different though COLLECTOR SUPPLY are connected with the terminal BASE of the device in both of two internal connections allocated in the F6 key.

Measured device and VERTICAL/HORIZONTAL settings

Combination of HORIZONTAL and VERTICAL display depends on range settings as shown below:

Note) When the HORIZONTAL setting is COLLECTOR, BASE-EMITTER is measured in F6 (BASE-COLLECTOR SUPPLY mode) in the above table.

HORIZONTAL setting	
COLLECTOR	
COLLECTOR	
BASE-EMITTER	
STEP	

When the connection destination of terminal BASE is Common, it becomes as shown in a left chart. There is a case of Step Generator and Open (A left chart is an example of Open) about the terminal EMITTER at the connection destination.

Note) If STEP GENERATOR doesn't connect when the HORIZONTAL setting is BASE-EMITTER, "HORIZ" is not displayed.

The waveform of each step is displayed at each 0.5div.

VERTICAL setting	
COLLECTOR	
EMITTER	
STEP	

When COLLECTOR SUPPLY is set to LEAKAGE

The waveform of each step is displayed at each 0.5div.

3.11.6 AUX key

Pressing AUX key ⑤ allows "AUX" menu to appear. The menu is used to set the output voltage to the auxiliary output (AUX terminal). The setting voltage is generated when measurement stops.

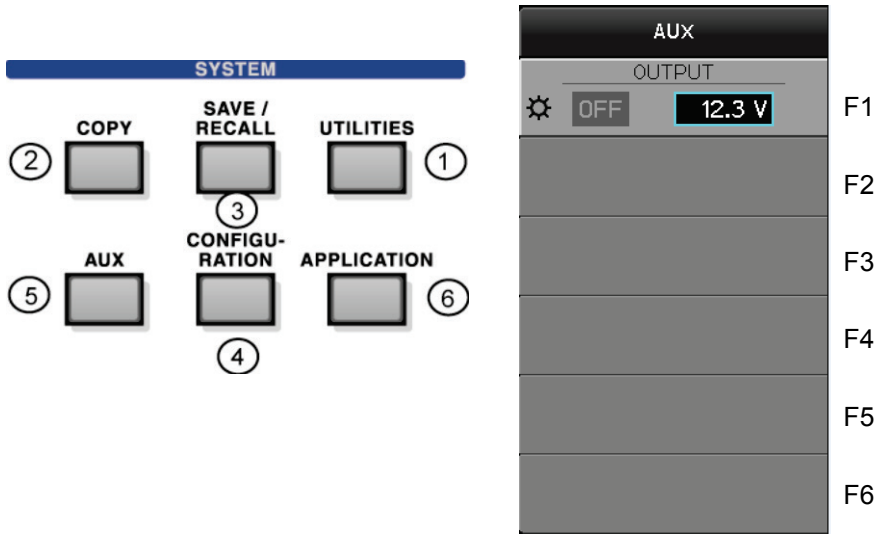

Submenu and function

F1	OUTPUT	OFF: Output off 0V to ±40.0V (in 0.1V step): Generates the voltage being set.
F2 to F6		(Not used)

3.11.7 APPLICATION key (option)

To use this function, it is necessary to install the option. If three left APPLICATION menu is displayed in gray when pressing APPLICATION key as shown below, the option should be purchased and the optional file should be installed. (Refer to Section 3.11.1.7. When purchasing it, contact Iwatsu office or our Web site (URL : <http://www.iti.iwatsu.co.jp>)).

If the option is already installed, pressing APPLICATION key ⑥ allows three right APPLICATION menu to appear as shown below.

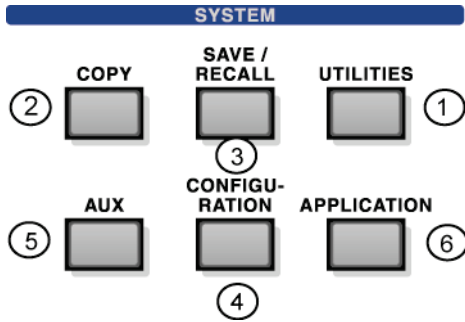

The option is not installed.

APPLICATION
Vth / hFE SETUP ▶
LIMIT SWEEP ▶
CONSTANT VOLTAGE / CURRENT ▶

Only CS-800 option installed.

APPLICATION
Vth / hFE SETUP ▶
LIMIT SWEEP ▶
CONSTANT VOLTAGE / CURRENT ▶

Only CS-801 option installed.

APPLICATION
Vth / hFE SETUP ▶
LIMIT SWEEP ▶
CONSTANT VOLTAGE / CURRENT ▶
COLLECTOR SWEEP DOUBLE ▶

Both CS-800 and CS-801 option installed.

APPLICATION
Vth / hFE SETUP ▶
LIMIT SWEEP ▶
CONSTANT VOLTAGE / CURRENT ▶
COLLECTOR SWEEP DOUBLE ▶

About function of semiconductor parameter search option CS-800

This section describes the outline and application of this option. For detailed settings, see Section 3.11.7.1 to Section 3.11.7.3.

This option includes Vth /h FE SETUP submenu, LIMIT SWEEP submenu, and CONSTANT VOLTAGE/ CURRENT submenu.

Since characteristics measurement of a semiconductor device includes a lot of parameters and conditions, the relationship with the 3rd or later parameters can be obtained by measuring the characteristics curve indicating the relationship between two parameters and measuring the multiple characteristics curves. The relationship with the 3rd or later parameters can be measured more detailedly and conveniently with use of the search function being set in Vth /h FE SETUP submenu (in this option), as shown in the example below.

This option, when carrying out SWEEP and search, is oriented to the target point (+ in the diagram) of I_C-V_{CE} as shown in the diagram below. It sets not only the current value and the voltage value of the target point but also SWEEP range of the step generator, SWEEP range of the collector supply (within dotted lines in the diagram), the permissible range (within inner frame in the diagram), the start point of SWEEP (● in the diagram), and the maximum number of SWEEP times (1 time: 1 SWEEP of step generator + 1 SWEEP of collector supply).

The measurement result of VERTICAL, HORIZONTAL, and STEP GENERATOR and calculation result (β) are displayed under the submenu (numeric value).

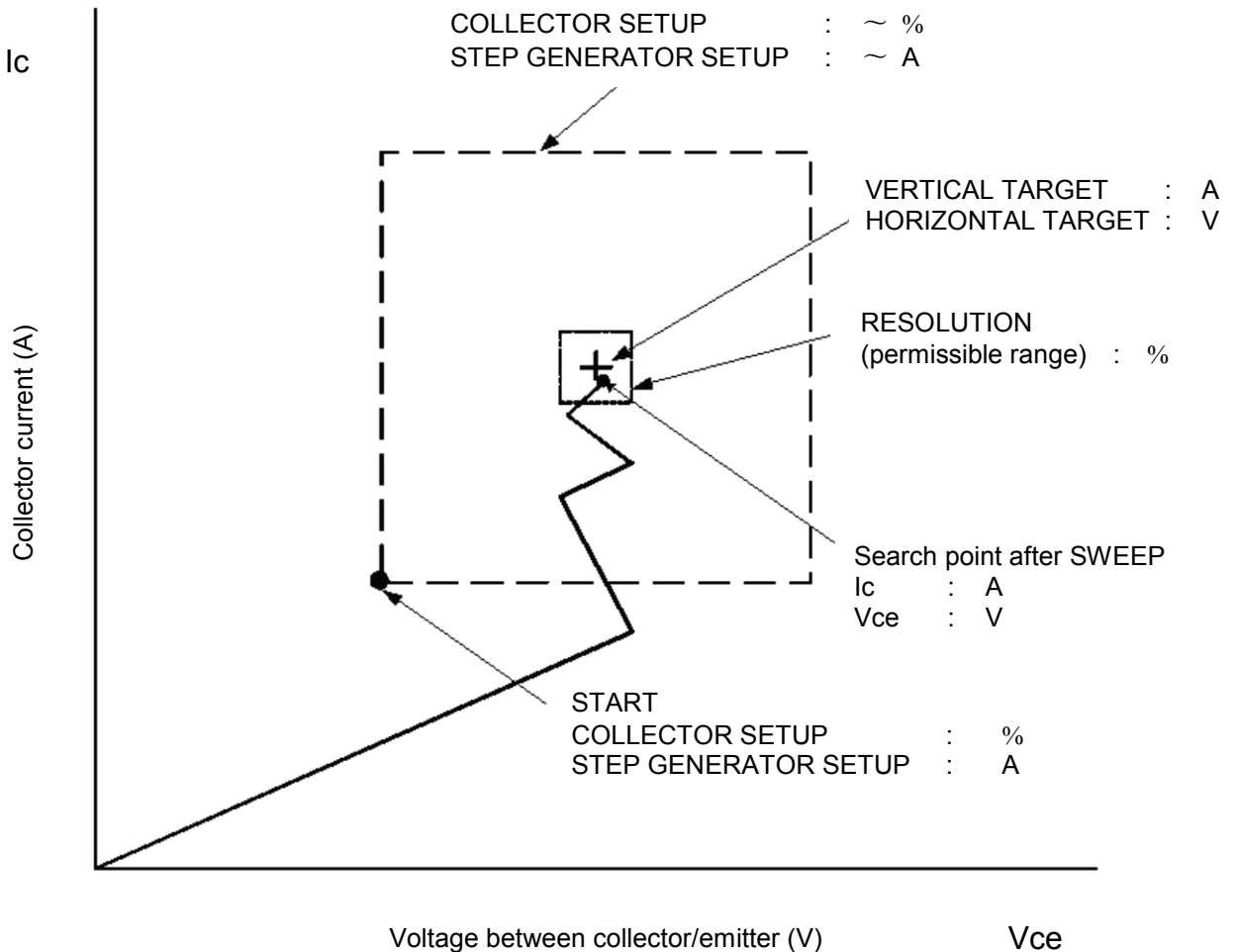

In LIMIT SWEEP submenu, it is possible to set LIMIT SWEEP function which puts restrictions on a measurement value of the vertical/horizontal axis. It is useful when:

- A measured device is to be protected by putting restriction on the current/voltage value.
- SWEEP is stopped at the preset current/voltage value.

It is possible to put restriction on either of vertical/horizontal axes or both. When starting SWEEP, it is possible to put restriction on normal SWEEP measurement using LIMIT SWEEP function. Therefore, LIMIT SWEEP is set to OFF in the initial state and only when required, it should be set to ON.

SWEEP key is used to start SWEEP of LIMIT SWEEP function.

CONSTANT VOLTAGE / CURRENT submenu can continuously apply constant voltage or current. It is effective in the load test to check reliability and stability of the semiconductor device. If this option is combined with the semiconductor parameter measurement application CS-810 (option) and allows the PC to remotely control the curve tracer itself, the device load can be automatically tested.

The feature of this function is to make stable long-sustained application of voltage or current since the voltage or current to be applied to the device keeps constant even if influence; e.g. environmental change and change to the device by the voltage or current to be applied is received. In this function, VOLTAGE or CURRENT is selected as the parameter to be constant.

However, specification can be made only to the voltage between the collector and emitter on the horizontal axis (V_{ce}) or the collector current on the vertical axis (I_c).

- * If the horizontal axis is the BASE – EMITTER range, this function cannot be used.

The settings below are made after selecting the parameter:

- Set the target value and the permissible range (%) of the parameter (voltage / current).
- Specify the range to return to the target value.
- * Measure the device characteristics in advance and rotate the VARIABLE knob of the curve tracer itself to decide the setting range of VARIABLE in the unit of %.
- Set the upper / lower limit values of the measurement values (V_{ce} and I_c) to protect the device when measuring it.

For details of setting, refer to Section 3.11.7.3.

When this function starts, SWEEP measurement is executed in the setting range from START VARIABLE preset by COLLECTOR SETUP and continuous application (REPEAT measurement) starts at the nearest point to the target value. If the measurement value exceeds the permissible range of the target during application because of environmental change, SWEEP measurement starts at that point in the setting range of COLLECTOR SETUP and returns to the nearest point to the target value.

If this value is out of the permissible range of the target, the error occurs; i.e. application stops. In addition, the value out of the range preset by OBSERVE SETUP is measured during application, the error occurs; i.e. application stops.

Note that when Vth CONSTANT VOLTAGE / CURRENT menu is executed, other keys are invalid excluding the ABORT key, the STOP key in the menu, and the CLEAR key to the front panel.

Example of measurement: Parameter search (IGBT module)

If you want to know V_{GE} (Gate Emitter Threshold Voltage) when I_C (collector current) is 800 mA and V_{CE} (voltage between collector and emitter) is 10 V, search is carried out in the order of ① ⇒ ② ⇒ ③ as shown below.

The permissible range for the target point is 3% in horizontal and vertical axes.

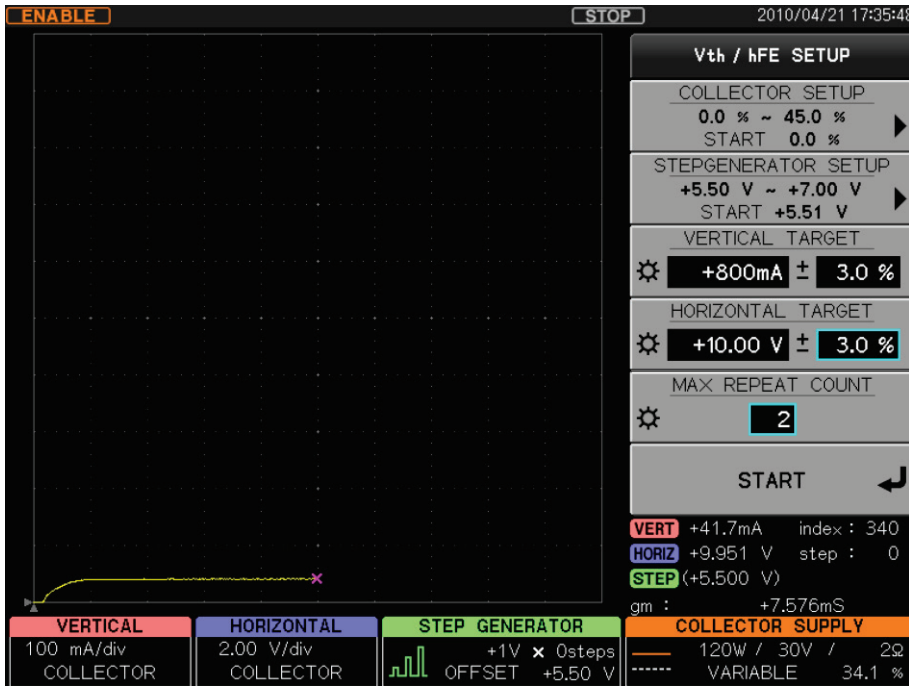

COLLECTOR SUPPLY SETUP

+

MINIMUM

0.0 %

MAXIMUM

45.0 %

RESOLUTION

0.1 %

START VARIABLE

0.0 %

STEP GENERATOR SETUP

+ -

MINIMUM

+ 5.50 V

MAXIMUM

+ 7.00 V

RESOLUTION

0.01 V

START OFFSET

+ 5.51 V

① First SWEEP for V_{CE} and I_C

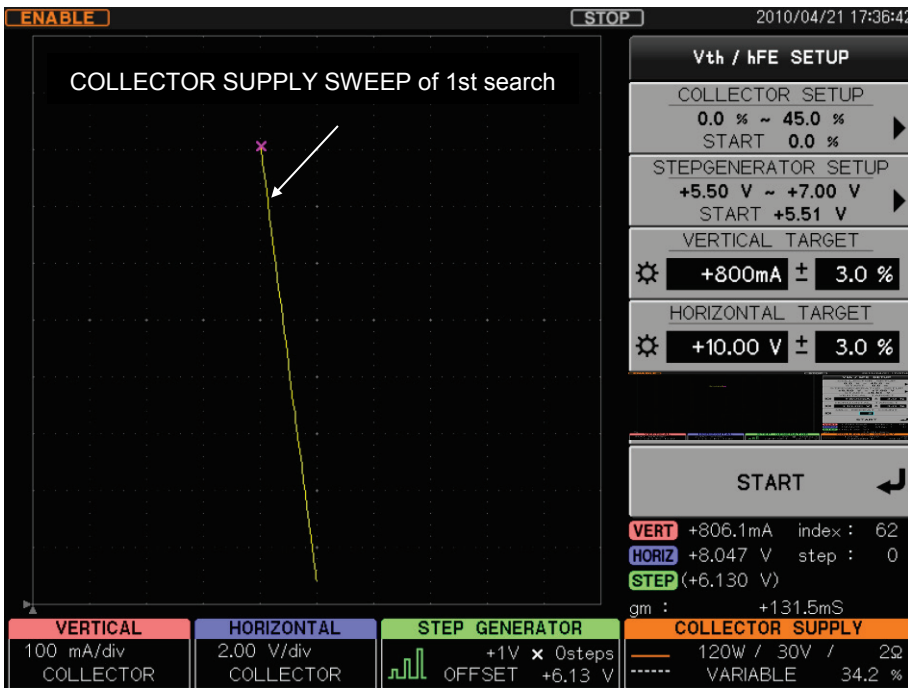

② 2nd SWEEPS for V_{CE} and I_c

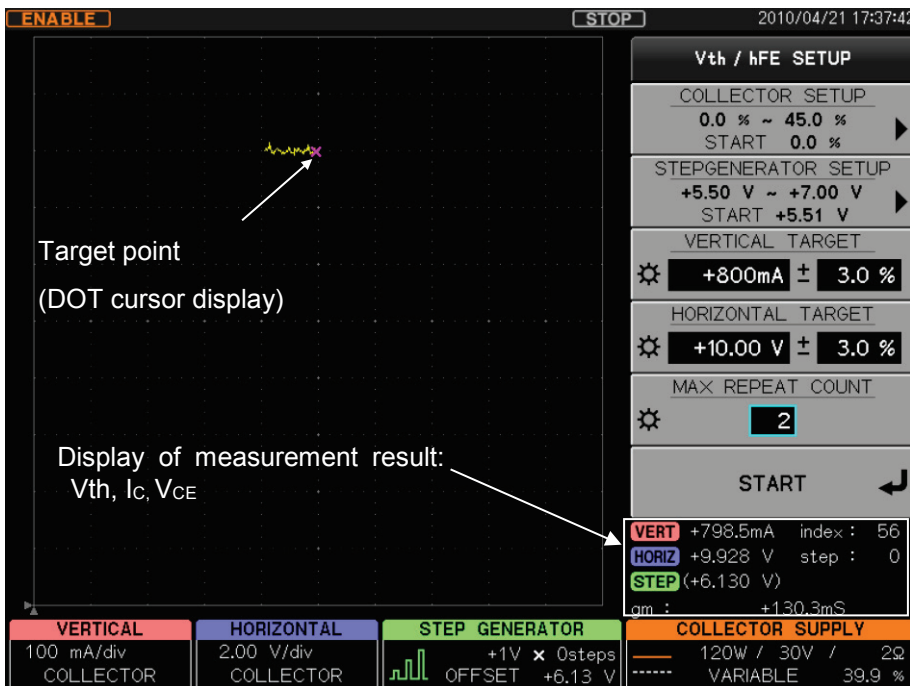

③ Search completion

<Measurement result>

V_{th} (Gate Emitter Threshold Voltage): 6.130 V
 I_c (collector current): 798.5 mA
 V_{CE} (voltage between collector and emitter): 9.928
 V : -6.014 V

About the function of DOUBLE SWEEP option CS-801

It explains the usage and the function of this option.

It is also possible to measure by the SWEEP function when measuring in this instrument. Four kinds of SWEEP functions are provided when dividing by the action (Refer to Section 3.8.3.).

The DOWN UP action in four kinds can be actioned by DOUBLE SWEEP option.

DOUBLE SWEEP is an optional function to observe hysteresis etc. when the I_c - V_{ce} characteristic etc. of the semiconductor devices are measured. The difference between the characteristic when SWEEP is done in the direction of UP and the characteristic when SWEEP is done in the direction of DOWN can be observed in a short time as shown in the figure below. (The example of the figure below is a drawn image figure because it explains to the last like there is an extreme difference.)

Do SWEEP in the direction of UP up to the set value of SWEEP END VARIABLE from the VARIABLE set value in SWEEP Start point A to Turning point B as shown in the figure below.

In addition, turn as it is continuously from Turning point B, and do SWEEP in the direction of DOWN up to the VARIABLE set value to SWEEP Start point A.

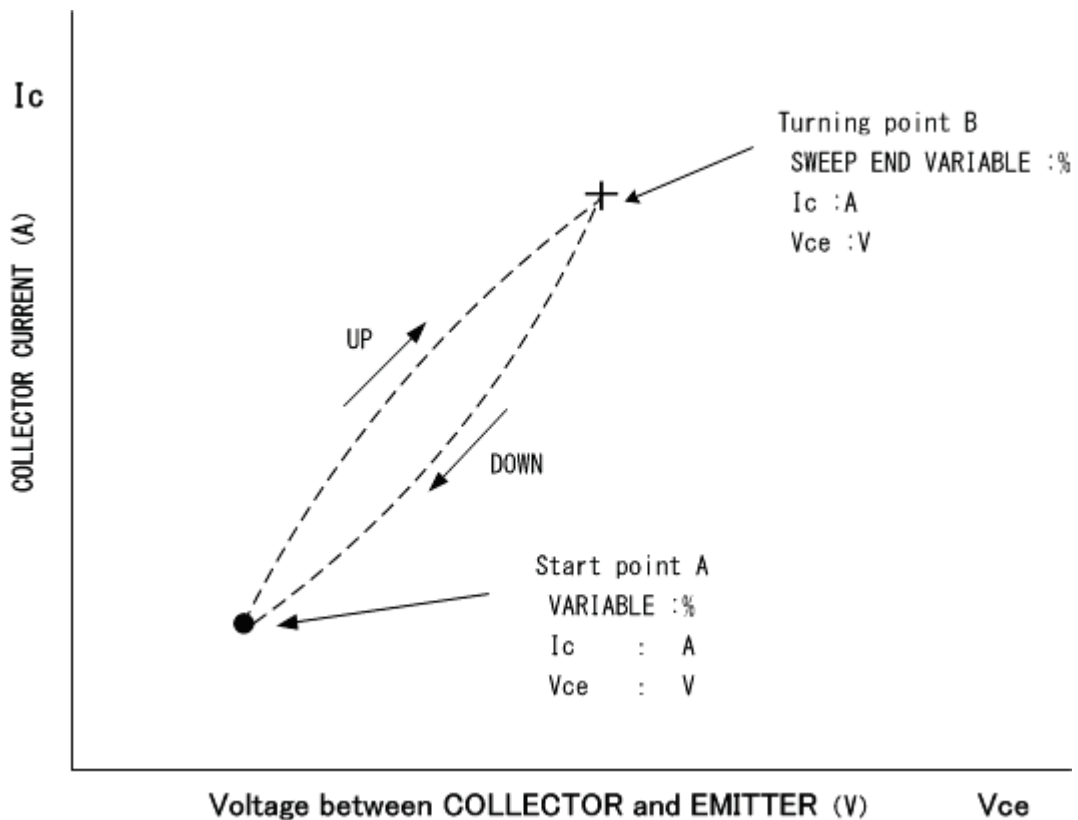

It is necessary to set COLLECTOR SWEEP DOUBLE available by the APPLICATION menu to make the function of this option available. Refer to Section 3.11.7.4 for the setting.

Moreover, it is necessary to set the item etc. of following (1) to (3) beforehand by the ACQUIRE menu about the action of this option. Refer to Section 3.7.5 for details of the setting item.

- (1) SWEEP TYPE: Select DOWN UP from four kinds of UP, DOWN, CUSTOM, and DOWN UP.
- (2) SWEEP END VARIABLE: Setting value of turn of DOUBLE SWEEP (%)
- (3) Setting value of VARIABLE: Setting value of start of DOUBLE SWEEP (%)

3.11.7.1 Vth/h FE SETUP submenu

Pressing F1 key allows Vth /h FE SETUP submenu to appear.

	APPLICATION	Vth / hFE SETUP	COLLECTOR SUPPLY SETUP	STEP GENERATOR SETUP
F1	Vth / hFE SETUP ▶	COLLECTOR SETUP 0.0 % ~ 25.0 % START 0.0 % ▶	—	+ —
F2	LIMIT SWEEP ▶	STEPGENERATOR SETUP -5.0μA ~ -15.0μA START -5.0μA ▶	MINIMUM 0.0 %	MINIMUM - 5.00μA
F3		VERTICAL TARGET -2.00mA ± 5.0 %	MAXIMUM 25.0 %	MAXIMUM - 15.00μA
F4		HORIZONTAL TARGET -6.00 V ± 5.0 %	RESOLUTION 0.1 %	RESOLUTION 0.05μA
F5		MAX REPEAT COUNT 5	START VARIABLE 0.0 %	START OFFSET - 5.00μA
F6		START ↵		

Key/knob	Setting items	Function description
F1	COLLECTOR SETUP	Displays items below. For detailed setting, press F1 key and make setting using COLLECTOR SUPPLY SETUP submenu (see next page). - SWEEP range of COLLECTOR SUPPLY - SWEEP start voltage of COLLECTOR SUPPLY
F2	STEP GENERATOR SETUP	Displays items below. For detailed setting, press F2 key and make setting using STEP GENERATOR SETUP submenu (see next page). - SWEEP range of STEP GENERATOR - SWEEP start current (or voltage) of STEP GENERATOR
F3 FUNCTION	VERTICAL TARGET	Sets a numeric value for item below. Use F3 key to make selection and use FUNCTION knob to set the value. - Target value of vertical axis: Setting range: within FULL range. - Permissible range of target value: ±0.0 to 20.0% (resolution 0.1%)
F4 FUNCTION	HORIZONTAL TARGET	Sets a numeric value for item below. Use F4 key to make selection and use FUNCTION knob to set the value. - Target value of horizontal axis: Setting range: within FULL range. - Permissible range of target value: ±0.0 to 20.0% (resolution 0.1%)
F5 FUNCTION	MAX REPEAT COUNT	FUNCTION knob is used to set the numeric value for the number of times that SWEEP is carried out up to target point. 1 COLLECTOR SUPPLY SWEEP + 1 STEP GENERATOR SWEEP = count 1 - Setting range: integer 1 to 50
F6	START / ABORT	After setting 5 items above, F6 key is pressed to start the search function. To cancel the search, F6 key is used to select ABORT or press CLEAR key. Note: This option function is not activated by REPEAT, SINGLE/STOP, and SWEEP keys of MEASUREMENT.

COLLECTOR SUPPLY SETUP submenu

Pressing F1 key allows COLLECTOR SUPPLY SETUP submenu to appear.

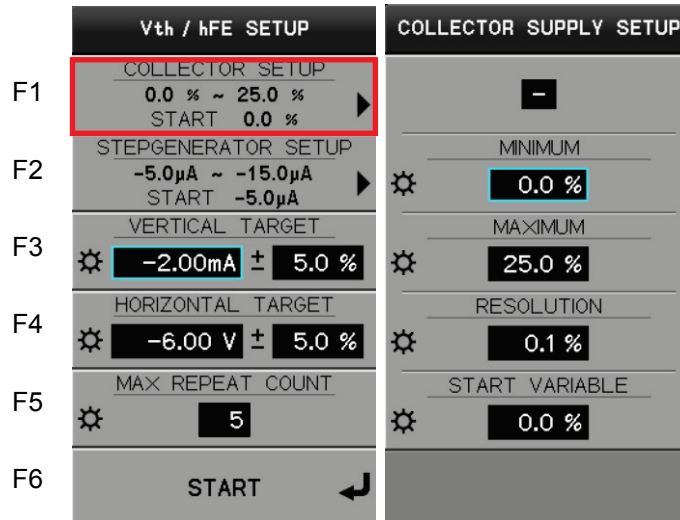

Key/knob	Setting items	Function description
F1	—	Displays the polarity of the output form COLLECTOR SUPPLY. It depends on the polarity of MODE/POLARITY menu of COLLECTOR
F2 FUNCTION	MINIMUM	Sets the minimum value of SWEEP range of COLLECTOR SUPPLY. If any value larger than MAXIMUM below or START VARIABLE setting value is set, the value of MAXIMUM or START VARIABLE is also changed to the same value - Setting range: 0.0 to 100.0% - Setting resolution: 0.1%
F3 FUNCTION	MAXIMUM	Sets the maximum value of SWEEP range of COLLECTOR SUPPLY. If any value smaller than MINIMUM or START VARIABLE setting value is set, the value of MINIMUM or START VARIABLE is also changed to the same value. - Setting range: 0.0 to 100.0% - Setting resolution: 0.1%
F4 FUNCTION	RESOLUTION	Sets the SWEEP resolution of COLLECTOR SUPPLY. If this option is used for operation, the resolution in this setting is used for SWEEP. Setting range: 0.1~5.0% - Setting resolution: 0.1%
F5 FUNCTION	START VARIABLE	Sets START value of SWEEP of COLLECTOR SUPPLY. The value should be set between values of MAXIMUM and MINIMUM. If any value out of the range from MAXIMUM to MINIMUM is to be set, the value is set to MAXIMUM or MINIMUM value; i.e., any value out of the range cannot be set.. - Setting range: 0.0 to 100.0% - Setting resolution: 0.1%
F6	—	(Not used)

STEP GENERATOR SETUP submenu

Pressing F2 key allows STEP GENERATOR SETUP submenu to appear.

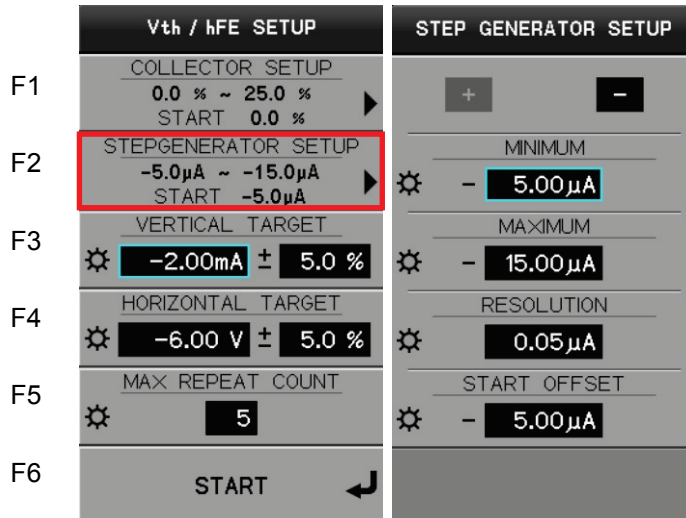

Key/knob	Setting items	Function description
F1	Polarity	F1 is used to select the polarity (+, -) for MINIMUM, MAXIMUM, START of the step generator. The setting should be consistent with the control polarity of the step generator.
F2 FUNCTION	MINIMUM	Sets the minimum value (absolute value) of SWEEP range of STEP GENERATOR. The setting range and setting resolution depend on STEP range. - Setting range: 10 times of STEP range - Setting resolution: 1/100 of STEP range
F3 FUNCTION	MAXIMUM	Sets the maximum value (absolute value) of SWEEP range of STEP GENERATOR. The setting range and setting resolution depend on STEP range. - Setting range: 10 times of STEP range - Setting resolution: 1/100 of STEP range
F4 FUNCTION	RESOLUTION	Sets the SWEEP resolution of STEP GENERATOR. If this option is used for operation, the resolution in this setting is used for SWEEP. - Setting range: STEP range × (0.01 to 1)
F5 FUNCTION	START OFFSET	Sets START value of SWEEP of STEP GENERATOR. - Setting range: MINIMUM value to MAXIMUM value - Setting resolution: 1/100 of STEP range
F6	—	(Not used)

3.11.7.2 LIMIT SWEEP submenu

Pressing F2 key allows LIMIT SWEEP submenu to appear.

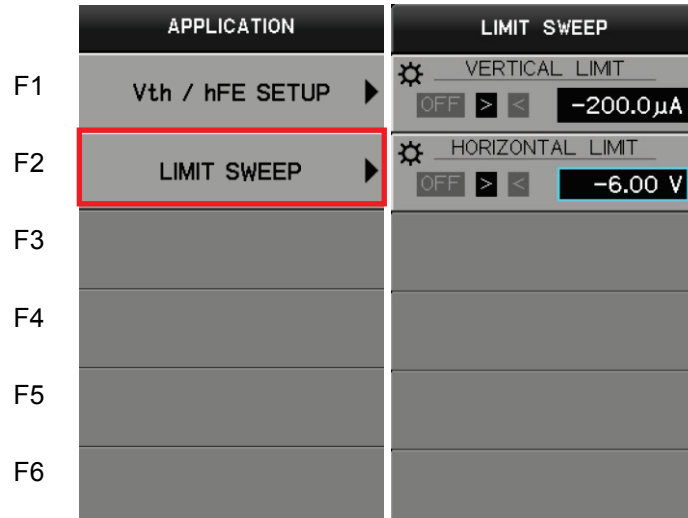

Key/knob	Setting items	Function description
F1 FUNCTION	VERTICAL LIMIT	F1 is used to select items below. The value is set by rotating FUNCTION knob. - OFF: No restriction on vertical axis - < setting value: Sets SWEEP restriction on the vertical axis. When any value equal to or smaller than the setting value is obtained, SWEEP stops. Points being swept are displayed. - > setting value: Set SWEEP restriction on the vertical axis. When any value equal to or larger than the setting value is obtained, SWEEP stops. Points being swept are displayed.
F2 FUNCTION	HORIZONTAL LIMIT	F2 is used to select items below. The value is set by rotating FUNCTION knob. - OFF: No restriction on horizontal axis - < setting value: Sets SWEEP restriction on the horizontal axis. When any value equal to or smaller than the setting value is obtained, SWEEP stops. Points being swept are displayed. - > setting value: Set SWEEP restriction on the horizontal axis. When any value equal to or larger than the setting value is obtained, SWEEP stops. Points being swept are displayed.
F3~F6		(Not used)

3.11.7.3 CONSTANT VOLT / CURR submenu

Pressing F3 function key allows CONSTANT VOLT / CURR submenu at the second from the left on the diagram below to appear.

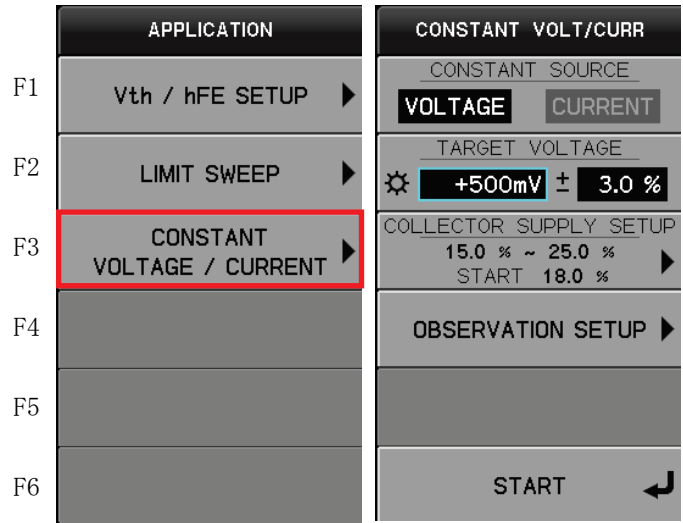

Key / knob	Setting items	Function description
F1	CONSTANT SOURCE	Press F1 key to select VOLTAGE or CURRENT for the parameter to be constant.
F2 FUNCTION HORIZONTAL VERTICAL	TARGET VOLTAGE / TARGET CURRENT	It measures the device characteristics in advance and sets the numeric value of TARGET of the parameter selected by F1 key. In addition, it sets the permissible range of the TARGET value in the unit of %. Press F2 key in sequence to select the setting target. <ul style="list-style-type: none"> ○ TARGET value: Set it by rotating FUNCTION knob or HORIZONTAL (V_{ce}) / VERTICAL (I_c). <ul style="list-style-type: none"> - Setting range: ±10 times of HORIZONTAL / VERTICAL range - Setting resolution: 1/50 of HORIZONTAL / VERTICAL range ○ Permissible range: Set it by rotating FUNCTION knob. <ul style="list-style-type: none"> - Setting range: 0.0 to 20.0% - Setting resolution: 0.1%
F3	COLLECTOR SUPPLY SETUP	It measures the device characteristics in advance and sets the range of the collector supply from % value of VARIABLE of the curve tracer itself. Refer to COLLECTOR SUPPLY SETUP submenu on the next page.
F4	OBSERVATION SETUP	It sets the numeric value of the upper/ lower limit values of the parameter (voltage/ current) to protect the device. Even if the range set by F3 above is too wide, measurement can be stopped at the upper / lower values. Refer to OBSERVATION SETUP on 2 pages later.
F5	—	(Not used)
F6	START/STOP	It starts application of constant voltage or current with the setting above. After start, it changes to STOP key in the menu. CLEAR key on the front panel can be used to stop the operation.

COLLECTOR SUPPLY SETUP submenu

Pressing F3 function key allows COLLECTOR SUPPLY SETUP submenu on the right in the diagram below to appear.

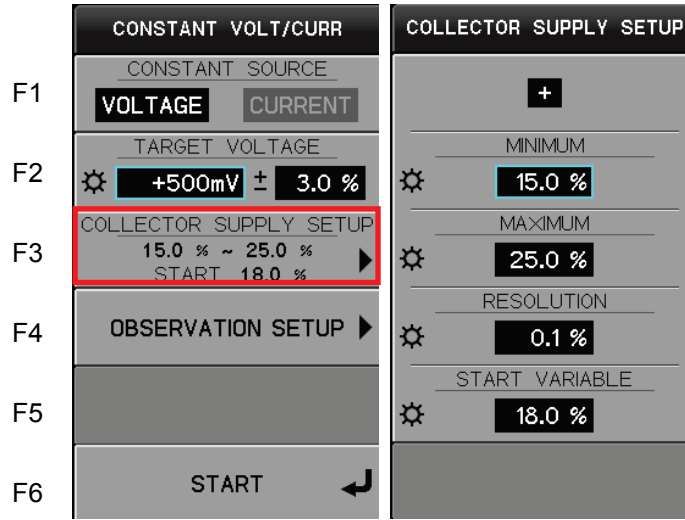

Key / knob	Setting items	Function description
F1	—	It displays the mode polarity (+/-) of COLLECTOR SUPPLY. * For polarity setting, refer to section 3.7.2: MODE POLARITY key.
F2 FUNCTION	MINIMUM	Press F2 key on the right menu in the diagram above to select the setting target. It sets the minimum value of the sweep range of COLLECTOR SUPPLY. If any value exceeding the setting value of MAXIMUM or START VARIABLE below is set, the value of MAXIMUM or START VARIABLE changes together; i.e. the same value is set. - Setting range: 0.0 to 100.0% - Setting resolution: 0.1%
F3 FUNCTION	MAXIMUM	Press F3 key on the right menu in the diagram above to select the setting target. It sets the maximum value of the sweep range of COLLECTOR SUPPLY. If any value less than setting value of MINIMUM or START VARIABLE is set, the value of MINIMUM or START VARIABLE changes together; i.e. the same value is set. - Setting range: 0.0 to 100.0% - Setting resolution: 0.1%
F4 FUNCTION	RESOLUTION	Press F4 key on the right menu in the diagram above to select the setting target. It sets the sweep resolution of COLLECTOR SUPPLY. If operation is done by this option, the resolution of this setting is used for sweep. - Setting range: 0.1 to 5.0% - Setting resolution: 0.1%
F5 FUNCTION	START VARIABLE	Press F5 key on the right menu in the diagram above to select the setting target It sets the sweep START value of COLLECTOR SUPPLY. Make setting between MAXIMUM and MINIMUM values above. If not, the setting value stops at MAXIMUM or MINIMUM value; i.e. setting cannot be made out of the range. - Setting range: 0.0 to 100.0% - Setting resolution: 0.1%
F6	—	(Not used)

OBSERVATION SETUP submenu

Pressing F4 function key allows OBSERVATION SETUP submenu on the right in the diagram below to appear.

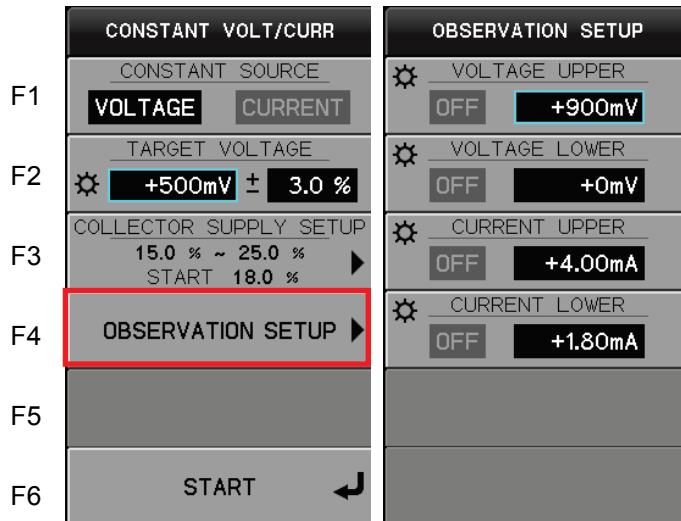

Key / knob	Setting items	Function description
F1 FUNCTION	VOLTAGE UPPER	Press F1 key on the right menu in the diagram above to select ON / OFF of the VOLTAGE UPPER function (ON: cursor (blue) on the right). If ON, the numeric value is set for the upper limit of COLLECTOR SUPPLY voltage. Setting range and resolution depend on the HORIZONTAL range. - Setting range: ±10 times of HORIZONTAL range - Setting resolution: 1/50 of HORIZONTAL range
F2 FUNCTION	VOLTAGE LOWER	Press F2 key on the right menu in the diagram above to select ON / OFF of the VOLTAGE LOWER function (ON: cursor (blue) on the right). If ON, the numeric value is set for the lower limit of COLLECTOR SUPPLY voltage. Setting range and resolution depend on the HORIZONTAL range. - Setting range: ±10 times of HORIZONTAL range - Setting resolution: 1/50 of HORIZONTAL range
F3 FUNCTION	CURRENT UPPER	Press F3 key on the right menu in the diagram above to select ON / OFF of the CURRENT UPPER function (ON: cursor (blue) on the right). If ON, the numeric value is set for the upper limit of COLLECTOR SUPPLY current. Setting range and resolution depend on the VERTICAL range. - Setting range: ±10 times of VERTICAL - Setting resolution: 1/50 of VERTICAL range
F4 FUNCTION	CURRENT LOWER	Press F4 key on the right menu in the diagram above to select ON / OFF of the CURRENT LOWER function (ON: cursor (blue) on the right). If ON, the numeric value is set for the lower limit of COLLECTOR SUPPLY current. Setting range and resolution depend on the VERTICAL range. - Setting range: ±10 times of VERTICAL range - Setting resolution: 1/50 of VERTICAL range
F5, F6	—	(Not used)

3.11.7.4 COLLECTOR SWEEP DOUBLE submenu

Press F4 key to display COLLECTOR SWEEP DOUBLE submenu.

	APPLICATION	COLLECTOR SWEEP DOUBLE	COLLECTOR SWEEP DOUBLE
F1	Vth / hFE SETUP ▶	COLLECTOR SWEEP DOUBLE OFF ON	COLLECTOR SWEEP DOUBLE OFF ON
F2	LIMIT SWEEP ▶		
F3	CONSTANT VOLTAGE / CURRENT ▶		
F4	COLLECTOR SWEEP DOUBLE ▶		
F5			
F6			

Key / knob	Setting items	Function description
F1 FUNCTION	COLLECTOR SWEEP DOUBLE	Press F1 key to select the following items. <ul style="list-style-type: none"> • OFF: The DOUBLE SWEEP function is invalid. • ON: The DOUBLE SWEEP function is valid.
F2 to F6		(Not used)

3.11.8 Default settings

This section explains default settings of this instrument: Table 3.11.1 shows settings for recall functions and Table 3.11.2 shows settings not for recall functions.

Table 3.11.1 Recall functions

Classification	Item name	Default setting
Configuration	CONFIGURATION	Collector/Step Gen/Common
Measurement	MEASUREMENT STATUS	REPEAT
Common to collector supply	UNIT (HIGH VOLTAGE / HIGH CURRENT)	HIGH VOLTAGE
	VARIABLE	0.0%
Collector supply HIGH VOLTAGE	MODE	AC
	POLARITY	POSITIVE
	MAX PEAK POWER WATTS	120 mW
	MAX PEAK VOLTAGE	30 V
	SINE FREQUENCY	50 Hz
Collector supply HIGH CURRENT (CS-5200/5300/5400)	POLARITY	POSITIVE
	MAX PEAK POWER WATTS	400 W (450 W for CS-5400)
	MAX PEAK VOLTAGE	40 V (30 V for CS-5400)
	PULSE INTERVAL	80 msec (100 msec for CS-5400)
Collector supply Others (common)	SWEEP STEPS	1000
	SWEEP TYPE	DOWN
	SWEEP END VARIABLE	0.0 %
	SWEEP WAIT TIME	0.0 sec
	HARDWARE COMPENSATION	0 %
	SOFTWARE COMPENSATION	0 %
	SWEEP START VARIABLE	0 %
Step generator	STEP/PULSE	STEP
	SOURCE	VOLTAGE
	POLARITY	POSITIVE
	OFFSET	0 (V/A)
	PULSE WIDTH	400 μsec
	MESUREMENT POINT	300 μsec
	OFFSET MODE	PULSED OFFSET
	NUMBER OF STEPS	0
	VOLTAGE STEP WIDTH	50 mV
	CURRENT STEP WIDTH	50 nA
	STEP 1/10	OFF
	SWEEP STEPS	X0

Classification	Item name	Default setting
Display	VECTOR	DOT
	AVERAGE	OFF
	AVERAGE PARAMETER	2
	PERSISTENCE	OFF
	PERSISTENCE	SHORT
	REF VIEW	OFF
	REF INDEX	1
	VIEW MODE	TRACE
	INVERT	OFF
	VERTICAL(Zoom)	OFF
	HORIZONTAL(Zoom)	OFF
	VERTICAL OFFSET POSITION	0.0 div
	HORIZONTAL OFFSET POSITION	0.0 div
	VERTICAL SENCE RANGE	2 A /div
	HORIZONTAL SENCE RANGE	COLLECTOR, 5 V /div
	WAVE 1st	Ic
	WAVE 2nd	Vce
	WAVE 1st Vbe RANGE	5 V /div
	WAVE 2nd Vce RANGE	5 V /div
	WAVE 1st / WAVE 2nd Ic RANGE	2 A /div
Cursor	CURSOR	OFF
	DISPLAY REFRESH RATE	MID
	step	0
	index	0
	F:intercept	+0 mV
	FREE CURSOR X POSITION	5.0 div
	FREE CURSOR Y POSITION	5.0 div
	WINDOW CURSOR UPPER POSITION	6.5 div
	WINDOW CURSOR LOWER POSITION	3.5 div
	WINDOW CURSOR RIGHT POSITION	7.5 div
	WINDOW CURSOR LEFT POSITION	2.5 div
AUX	OUTPUT	OFF
	OUTPUT AMPLITUDE	0.0 V

Classification	Item name	Default setting
APPLICATION	VERTICAL TARGET	0.0 A
	VERTICAL PRECISION	0.0 %
	HORIZONTAL TARGET	0.0 V
	HORIZONTAL PRECISION	0.0 %
	COLLECTOR SUPPLY MINIMUM	0.0 %
	COLLECTOR SUPPLY MAXIMUM	0.0 %
	COLLECTOR SUPPLY START	0.0 %
	COLLECTOR SUPPLY RESOLUTION	0.1 %
	STEP GENERATOR MINIMUM	0.0
	STEP GENERATOR MAXIMUM	0.0
	STEP GENERATOR START	0.0
	STEP GENERATOR RESOLUTION	(Resolution of STEP OFFSET)
	MAX REPEAT COUNT	1
	VERTICAL LIMIT	0.0 A
	VERTICAL LIMIT (type)	OFF
	HORIZONTAL LIMIT	0.0 V
	HORIZONTAL LIMIT (type)	OFF
	CONSTANT SOURCE	VOLTAGE
	TARGET VOLTAGE	0.0 V
	TARGET VOLTAGE (permissible range)	0.0 %
	COLLECTOR SUPPLY SETUP MINIMUM	0.0 %
	COLLECTOR SUPPLY SETUP MAXIMUM	0.0 %
	COLLECTOR SUPPLY SETUP RESOLUTION	0.1 %
	COLLECTOR SUPPLY SETUP START VARIABLE	0.0 %
	OBSERVATION SETUP VOLTAGE UPPER	0.0 V
	OBSERVATION SETUP VOLTAGE LOWER	0.0 V
	OBSERVATION SETUP CURRENT UPPER	0.0 A
	OBSERVATION SETUP CURRENT LOWER	0.0 A
	COLLECTOR SWEEP DOUBLE	OFF

Table 3.11.2 Not recall functions

Classification	Item name	Default setting
System	Setup when powering on	DEFAULT
	Beep	ON
	HEADER	DATE
	COMMENT	IWATSU CS-3X00
System-setting measurement	VARIABLE at RECALL	RECALL
	VARIABLE at INTERLOCK	HOLD
	COLLECTOR SUPPLY OUTPUT at MEASURE STOP	LEAK ONLY
Remote connection	DHCP	ON
	IP Address at manual setting	192.168.1.102
	Subnet Mask at manual setting	255.255.255.0
	Default Gateway at manual setting	192.168.1.1
Remote operation	Waveform transfer format	ASCII
Brightness setting	WAVEFORM	100%
	GRID	50%
	CURSOR	100%
	REF	80%
	BACKLIGHT	MID
Hard copy	FILE FORMAT	PNG
	BACKGROUND	Black
	COLOR	Color
	FILE NAME	"SCRN0000"
Save	DATA TYPE	SETUP
	TO	INTERNAL
	DATA FORMAT	BINARY
	SETUP FILE NAME	"STUP0000"
	TRACE FILE NAME	"WAVE0000"
	REF FILE NAME	"RFFR0000"
	SETUP NO.	1
	REF .NO.	1
Recall	DATA TYPE	SETUP
	FROM for SETUP	INTERNAL
	FROM for REF	USB memory
	FILE LIST	"NoSelect"
	SETUP NO.	1

Classification	Item name	Default setting
Recall	REF .NO.	1
Delete	DATA TYPE	SETUP
	FROM for SETUP	INTERNAL
	FROM for REF	INTERNAL
	DATA FORMAT	BINARY
	FILE LIST	"NoSelect"
	SETUP NO.	1
	REF .NO.	1

Chapter4 Characteristics Measurement

Section 4.1 "Quick start guide" of this chapter allows the beginner of the curve tracer to well understand the relationship between operation of keys and knobs on the front panel and the menu screen settings, and to prepare the performance table for a device to be measured. This chapter allows you to learn the settings (SETUP) of the curve tracer using examples of performance tables of a diode, transistor, and FET. Each section shows first the measurement result of a measured device, the example of extracts from the performance table, connection method, and cautions, and then explains the concrete measurement procedure.

Section 4.2 "Characteristics measurement" shows, using the latest device: IGBT, the connection method, measurement procedure, and characteristics measurement result when measuring large current.

Extracts from performance tables in the yellowish green frame at the beginning of each section for explanation of characteristics measurement are used only as examples for this manual. When measuring characteristics actually, it is necessary to prepare your own performance table for each measured device.

■ Section 4.1 Quick start guide

4.1.1 Diode measurement

4.1.2 Transistor measurement

4.1.3 N-channel junction FET measurement

■ Section 4.2 Characteristics measurement

4.2.1 IGBT characteristics measurement

4.1 Quick start guide

This section explains examples of measuring device characteristics of a diode, transistor, and FET.

4.1.1 Diode measurement

This section explains procedures to measure the forward characteristics of a diode, the ON resistance value of a diode using the cursor, and the forward characteristics of a diode.

4.1.1.1 Measuring forward characteristics of diode

The diagram on the right in this frame shows the measurement result of the forward characteristics based on the diode performance table below.

In addition, extracts from the performance table of device characteristics which should be investigated in advance and the connection diagram indicating how to connect a measured device to the attached test adapter are shown.

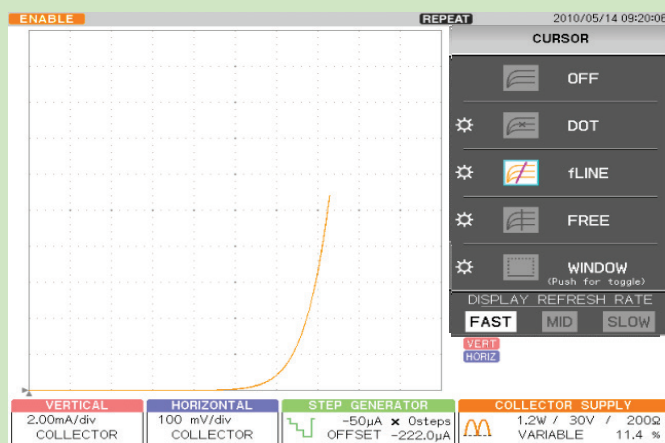

Diode forward characteristics

Extracts from diode performance table

Absolute max. rating

Peak reverse voltage	V_{RM}	70 V
Peak forward current	I_{FM}	450 mA
Permissible loss	I_o	250mW

Electric characteristics

Item	Measurement conditions	Measurement value/Max.
Forward Voltage V_F	$I_F=10mA$	0.8 V

Connection diagram

Connect the anode of the diode to the collector terminal of the test adapter and the cathode to the emitter terminal. For connection between the test fixture and main unit, see Section 3.3.2.

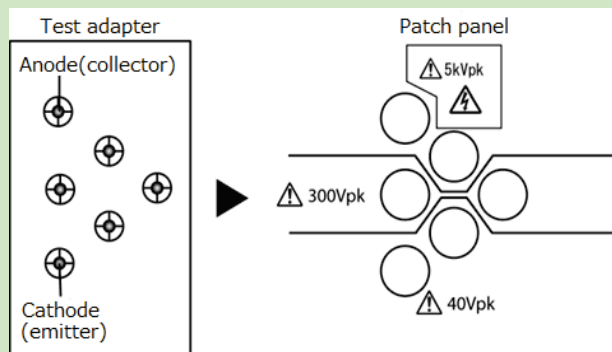

Caution! When starting or finishing measurement, operate CS-5000 as shown below:

- ◆ When starting measurement, set HIGH VOLTAGE breaker to DISABLED and open the test fixture.
- ◆ After connecting a measured device, set HIGH VOLTAGE breaker to ENABLED.
- ◆ After finishing measurement, rotate VARIABLE counterclockwise to set the value to 0% (to discharge applied voltage).
- ◆ Set HIGH VOLTAGE breaker to DISABLED.

■ Measurement procedure

(1) Press MAX PEAK POWER- WATTS key.

(2) Press F4 key and set to 1.20 W.

Because the permissible loss of the measured device $I_0=250$ mW in accordance with the performance table.

(3) Press MAX PEAK VOLTS key.

(4) Press F3 key and set to 30V.

Measurement voltage =0.8 V in accordance with the performance table.



(5) Press MODE/POLARITY key.

(6) Press F1 key and set to HIGH VOLTAGE.

(7) Press F3 key and set RECTIFIED SINE to "+ (+full-wave rectified)."

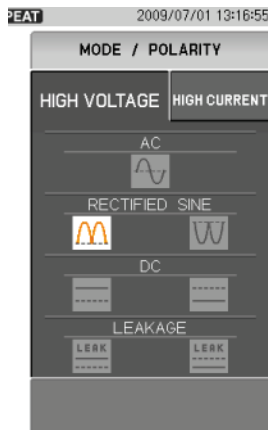

- (8) Press CONFIGURATION key.
- (9) Press F3 key and set to Collector/Short/Common.

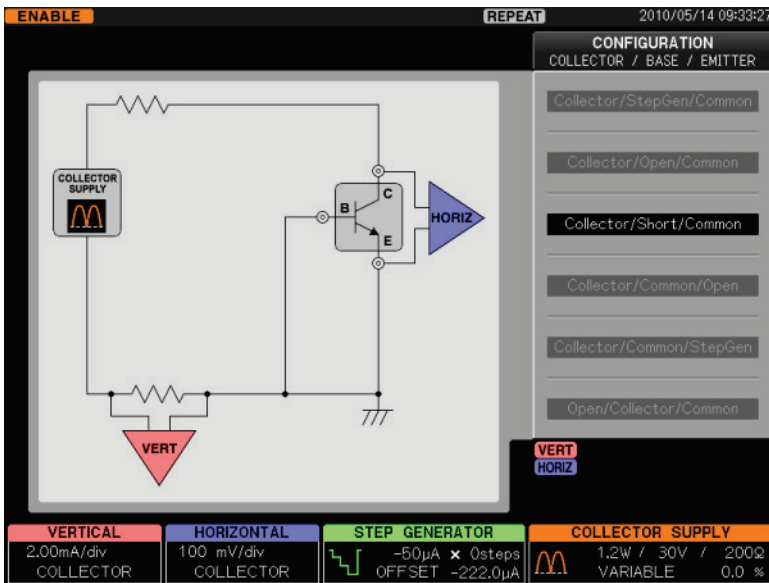

COLLECTOR SUPPLY setting is displayed.

- (10) Press CLEAR key.
- (11) Set VERTICAL to 2.00 mA/div and COLLECTOR.
- (12) Set HORIZONTAL to 100 mV/div and COLLECTOR.

- (13) Set HIGH VOLTAGE breaker to ENABLED.
- (14) Gradually rotate VARIABLE clockwise to apply a voltage to the device.

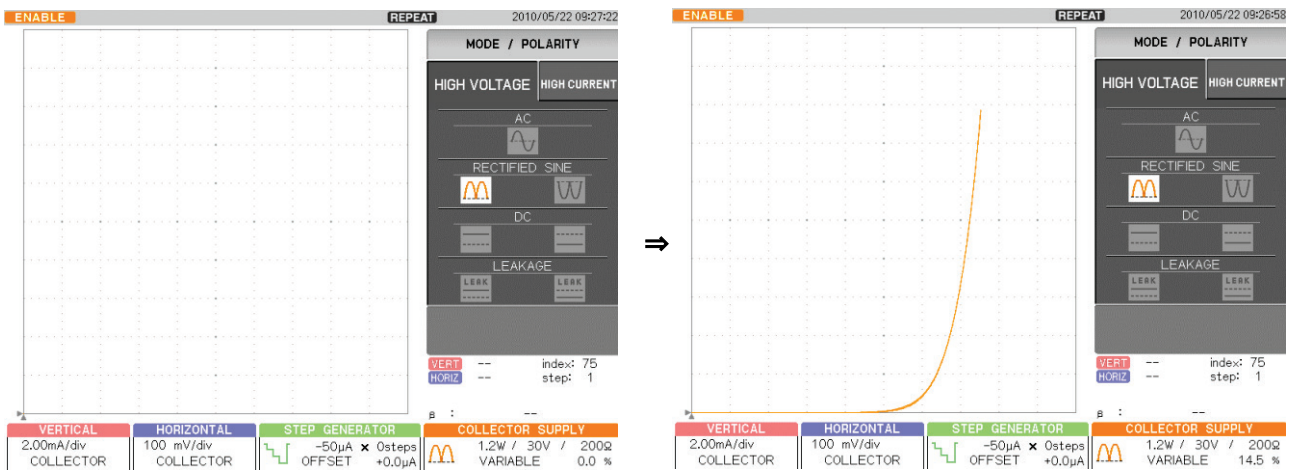

4.1.1.2 Measuring diode ON resistance

The diagram on the right in this frame shows the measurement result of the diode ON resistance based on the extracts from the diode performance table below.

In addition, extracts from the performance table of device characteristics which should be investigated in advance and the connection diagram indicating how to connect a measured device to the attached test adapter are shown.

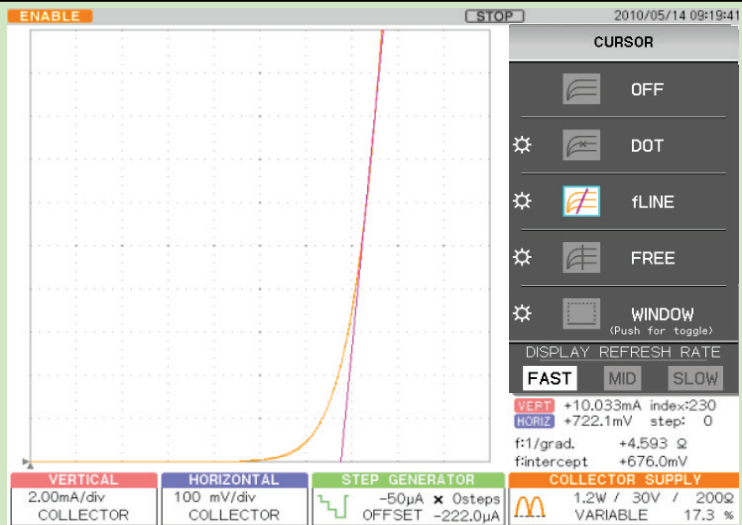

Diode ON resistance

Connection diagram

Connect the anode of the diode to the collector terminal of the test adapter and the cathode to the emitter terminal. For connection between the test fixture and main unit, see Section 3.3.2.

Extracts from diode performance table

Absolute max. rating

Peak reverse voltage	V_{RM}	70 V
Peak forward current	I_{FM}	450 mA
Permissible loss	I_O	250mW

Electric characteristics

Item	Measurement conditions	Measurement value/Max.
Forward voltage V_F	$I_F=10mA$	0.8 V

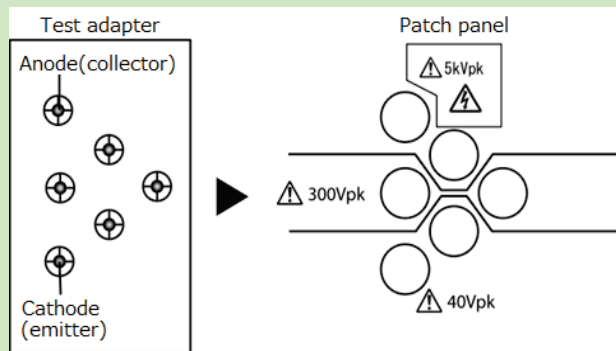

Caution! When starting or finishing measurement, operate CS-5000 as shown below:

- ◆ When starting measurement, set HIGH VOLTAGE breaker to DISABLED and open the test fixture.
- ◆ After connecting a measured device, set HIGH VOLTAGE breaker to ENABLED.
- ◆ After finishing measurement, rotate VARIABLE counterclockwise to set the value to 0% (to discharge applied voltage).
- ◆ Set HIGH VOLTAGE breaker to DISABLED.

■ Measurement procedure

The diode ON resistance is measured using the cursor.

For the measurement procedure, see steps from (1) to (14) in Section 4.1.1.1.

- (1) Press CURSOR key.
- (2) Press F2 key on the right of the submenu "DOT."
- (3) Rotate FUNCTION knob to move DOT to an arbitrary measurement point (diode ON position).
VERT (current) value and HORIZ (voltage) value at the cursor position (index) are displayed.

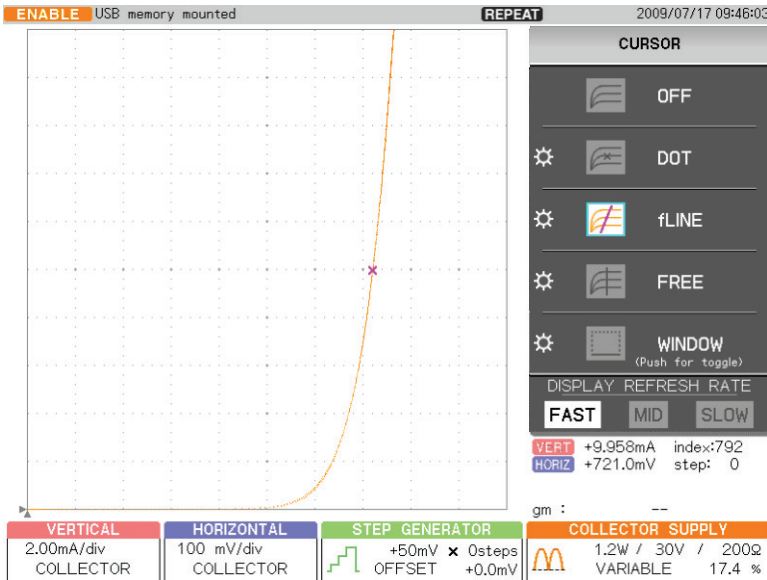

Current/voltage values at DOT cursor point

- (4) On the cursor menu, press F3 on the right of the submenu "fLINE."
- (5) Rotate FUNCTION knob so that the gradient of fLINE cursor is tangential to the characteristics curve.
- (6) The diode ON resistance value at the connection point is displayed in the readout of CURSOR (f:1/grad).

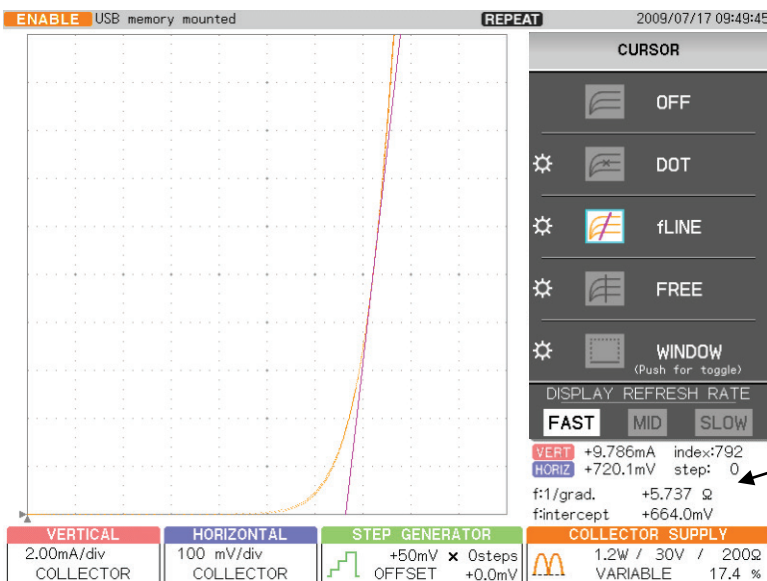

Diode ON resistance

4.1.1.3 Measuring reverse characteristics (breakdown) of diode

The diagram on the right in this frame shows the measurement result of the reverse characteristics based on the diode performance table below.

In addition, extracts from the performance table of device characteristics which should be investigated in advance and the connection diagram indicating how to connect a measured device to the attached test adapter are shown.

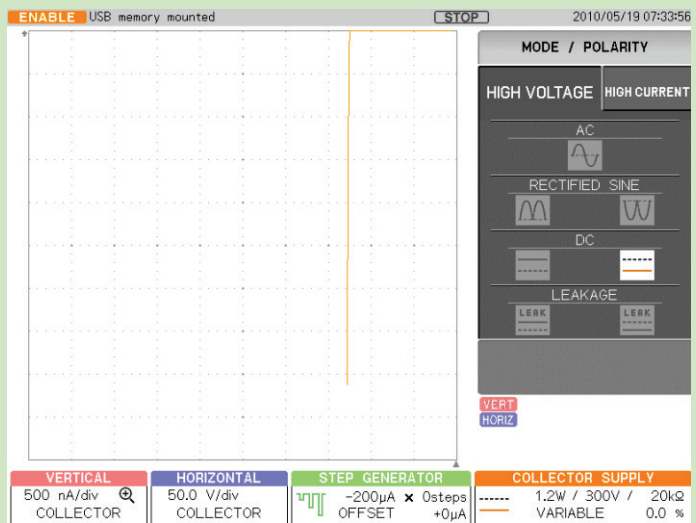

Diode reverse characteristics

Extracts from diode performance table

Absolute max. rating

Peak reverse voltage	V_{RM}	70 V
Peak forward current	I_{FM}	450 mA
Permissible loss	I_O	250mW

Electric characteristics

Item	Measurement conditions	Measurement value/Max.
Reverse current I_R	$V_R=60$ V	0.1µA

Connection diagram

Connect the anode of the diode to the collector terminal of the test adapter and the cathode to the emitter terminal. For connection between the test fixture and main unit, see Section 3.3.2.

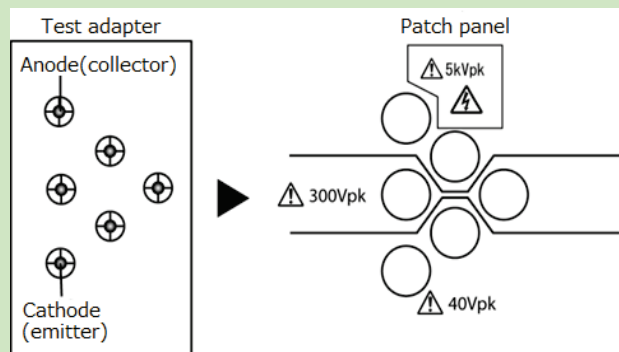

Caution! When starting or finishing measurement, operate CS-5000 as shown below:

- ◆ When starting measurement, set HIGH VOLTAGE breaker to DISABLED and open the test fixture.
- ◆ After connecting a measured device, set HIGH VOLTAGE breaker to ENABLED.
- ◆ After finishing measurement, rotate VARIABLE counterclockwise to set the value to 0% (to discharge applied voltage).
- ◆ Set HIGH VOLTAGE breaker to DISABLED.

■ Measurement procedure

- (1) Press MAX PEAK POWER- WATTS key.
- (2) Press F4 key and set to 1.20 W.

Because the permissible loss of the measured device $I_o=250$ mW in accordance with the performance table.

- (3) Press MAX PEAK VOLTS key.
- (4) Press F3 key and set to 300 V.

Measurement condition voltage =60 V in accordance with the performance table.

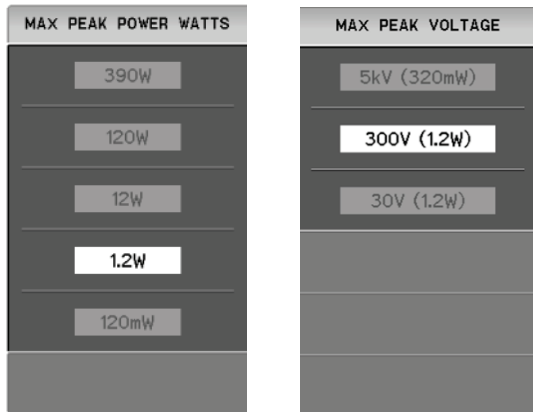

- (5) Press MODE/POLARITY key.
- (6) Press F1 key and set to HIGH VOLTAGE.
- (7) Press F3 key and set to -DC.

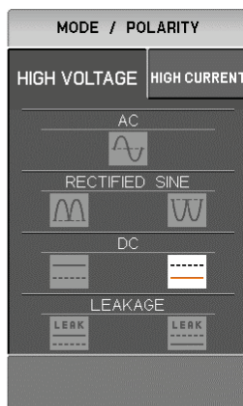

- (8) Press CONFIGURATION key.
- (9) Press F3 key and set to Collector/Short/Common.
- (10) Press CLEAR key.

COLLECTOR SUPPLY setting is displayed.

VERTICAL	HORIZONTAL	STEP GENERATOR	COLLECTOR SUPPLY
2.00mA/div COLLECTOR	100 mV/div COLLECTOR	+50mV × 0steps OFFSET +0.0mV	1.2W / 300V / 20kΩ VARIABLE 0.0 %

(14)
(11)

- (11) Set VERTICAL to 1.00μA/div and COLLECTOR.
- (12) Press ZOOM key and F1 key, and select VERTICAL.
- (13) Rotate FUNCTION knob to select "x2".
- (14) Set HORIZONTAL to 50V/div and COLLECTOR.
- In accordance with the reverse current I_R and the reverse voltage V_R of the diode.
- (15) Set HIGH VOLTAGE breaker to ENABLED.
- (16) Gradually rotate VARIABLE clockwise to apply a voltage to the device.
- (17) Press SWEEP key in MEASUREMENT part.
- For SWEEP measurement, see Section 3.8.3.

VERTICAL	HORIZONTAL	STEP GENERATOR	COLLECTOR SUPPLY
500 nA/div COLLECTOR	50.0 V/div COLLECTOR	-200μA × 0steps OFFSET +0μA	1.2W / 300V / 20kΩ VARIABLE 0.0 %

4.1.2 Transistor measurement

This section shows examples of measuring $I_C - V_{CE}$ characteristics based on the performance table for transistor. The examples include measurement which obtains DC current amplification factor (h_{FE}) and each resistance parameter using the cursor, based on the measurement results. In addition, the examples include measurement for I_C vs. V_{BE} characteristics, I_C vs. I_B characteristics, and I_B vs. V_{CE} characteristics under the same conditions and in the different mode.

4.1.2.1 I_C vs. V_{CE} characteristics

4.1.2.2 DC current amplification factor (h_{FE}) and resistance measurement

4.1.2.3 I_C vs. V_{BE} characteristics

4.1.2.4 I_C vs. I_B characteristics

4.1.2.5 I_B vs. V_{CE} characteristics

4.1.2.1 I_C vs. V_{CE} characteristics

It explains measurement procedure for I_C vs. V_{CE} characteristics based on the performance table of PNP transistor.

The diagram on the right in this frame shows the measurement result of I_C vs. V_{CE} characteristics of a transistor based on the extracts from the transistor performance table below.

In addition, extracts from the performance table of device characteristics which should be investigated in advance and the connection diagram indicating how to connect a measured device to the attached test adapter are shown.

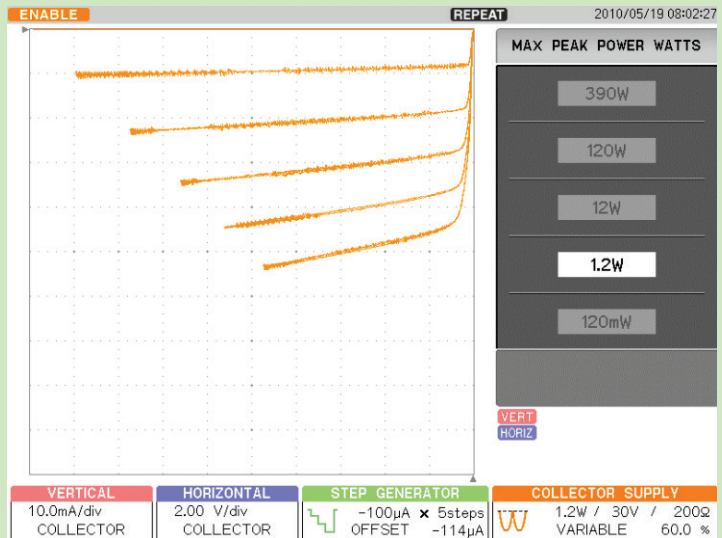

I_C vs. V_{CE} characteristics of a transistor

Extracts from transistor performance table

Absolute max. rating		
Voltage between collector/base V_{CBO}		-50 V
Voltage between collector/emitter V_{CEO}		-50 V
Voltage between emitter/base V_{EBO}		-5 V
Collector current I_C		-150 mA
Base current I_B		-50 mA
Collector loss P_C		400 mW
Electric characteristics		
Item	Measurement conditions	Measurement value/standard
DC current amplification factor	$V_{CE}=-6$ V $I_C=-100$ mA	70-400

Connection diagram

Connect the collector/base/emitter terminals of a transistor to the collector/base/emitter terminals of the test adapter. For connection between the test fixture and main unit, see Section 3.3.2.

Note: When oscillation is made, mount the base resistance properly.

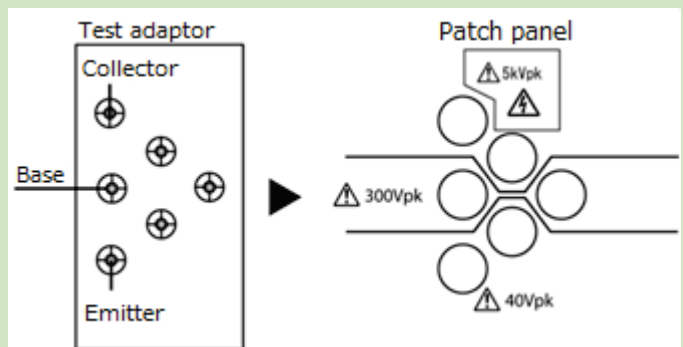

Caution! When starting or finishing measurement, operate CS-5000 as shown below:

- ◆ When starting measurement, set HIGH VOLTAGE breaker to DISABLED and open the test fixture.
- ◆ After connecting a measured device, set HIGH VOLTAGE breaker to ENABLED.
- ◆ After finishing measurement, rotate VARIABLE counterclockwise to set the value to 0% (to discharge applied voltage).
- ◆ Set HIGH VOLTAGE breaker to DISABLED.

■ Measurement procedure

(1) Press MAX PEAK POWER- WATTS key.

(2) Press F4 key and set to 1.20 W.

Collector loss $I_C = 400$ mW in accordance with the performance table.

(3) Press MAX PEAK VOLTS key.

(4) Press F3 key and set to 30V.

Measurement condition $V_{CE} = -6$ V in accordance with the performance table.

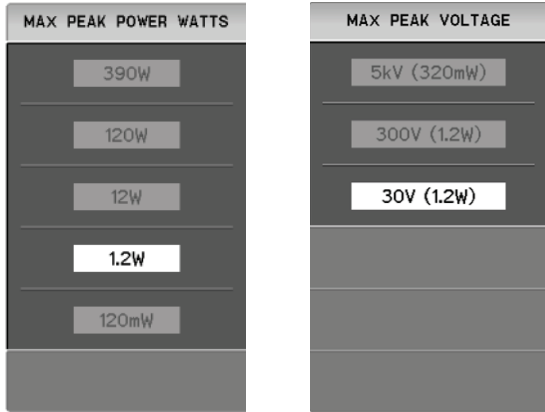

(5) Press CONFIGURATION key.

(6) Press F1 key and set to Collector/StepGen/Common.

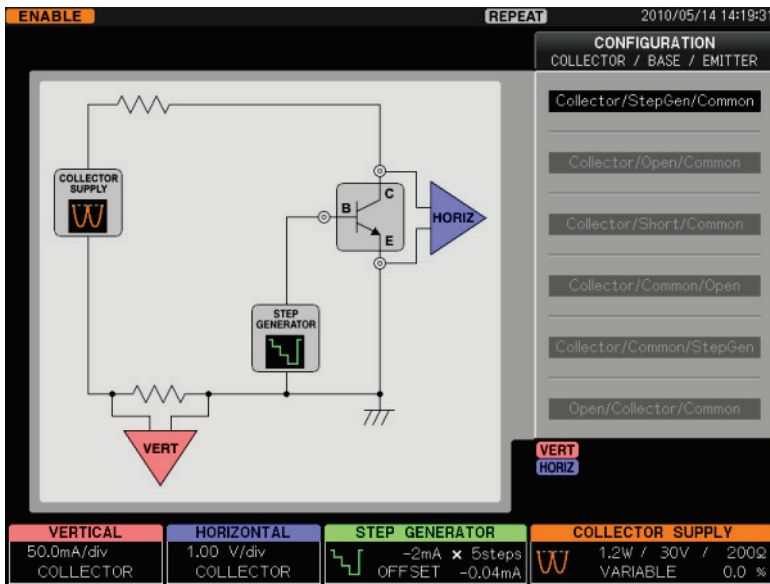

- (7) Press CLEAR key.
- (8) Press STEP GENERATOR MENU key.
- (9) Press F1 key to select "-STEP."
PNP transistor: minus bias, NPN transistor: plus bias
- (10) Press F3 key to select "CURRENT."
- (11) Rotate FUNCTION knob to set NUMBER OF STEPS to 5.

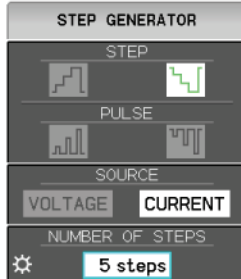

- (12) Rotate STEP AMPLITUDE knob to set to $-200 \mu\text{A}/\text{div}$.
Measurement condition $I_C = -100 \text{ mA}$, $h_{FE}=70$ to 400
in accordance with the performance table.



- (13) Press OFFSET knob to set OFFSET to 0.

- (13) Press MODE/POLARITY key.
- (14) Press F1 key and set to HIGH VOLTAGE.
- (15) Press F3 key and set RECTIFIED SINE to "-" (- full-wave rectified).

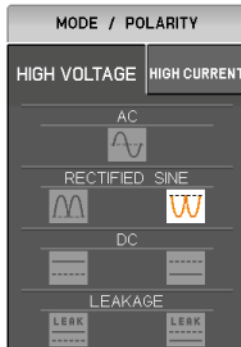

- (16) Set VERTICAL to $20.0 \text{ mA}/\text{div}$ and COLLECTOR.
Make proper setting for measurement condition I_C in accordance with the performance table.
- (17) Set HORIZONTAL to $1.00 \text{ V}/\text{div}$ and COLLECTOR.
Make proper setting for measurement condition V_{CE} in accordance with the performance table.



- (18) Set HIGH VOLTAGE breaker to ENABLED.
- (19) Gradually rotate VARIABLE clockwise to apply a voltage to the device.

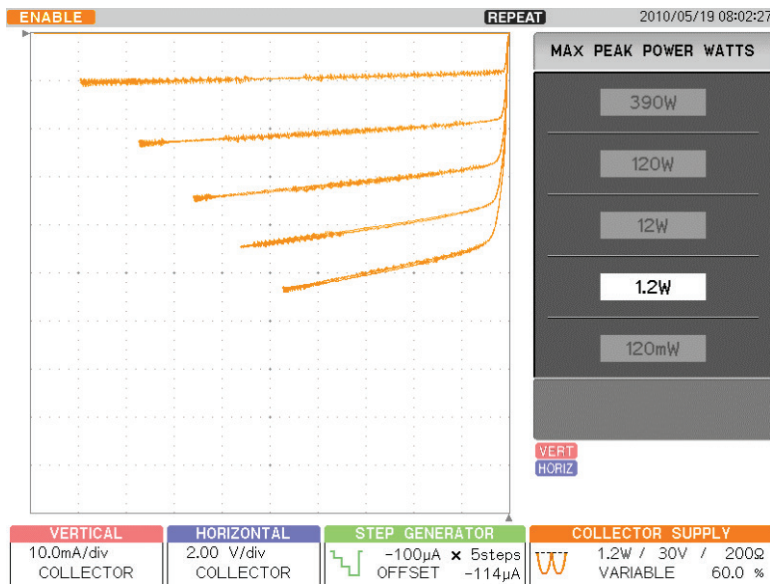

4.1.2.2 Measuring DC current amplification factor (h_{FE})

It explains the measurement procedure of DC current amplification factor (h_{FE}) under the same conditions as "Section 4.1.2.1 I_C vs. V_{CE} characteristics," based on the extracts from the performance table for PNP transistors.

The diagram on the right in this frame shows the measurement result of DC current amplification factor (h_{FE}) of a transistor based on the extracts from the transistor performance table below. In addition, extracts from the performance table of device characteristics which should be investigated in advance and the connection diagram indicating how to connect a measured device to the attached test adapter are shown.

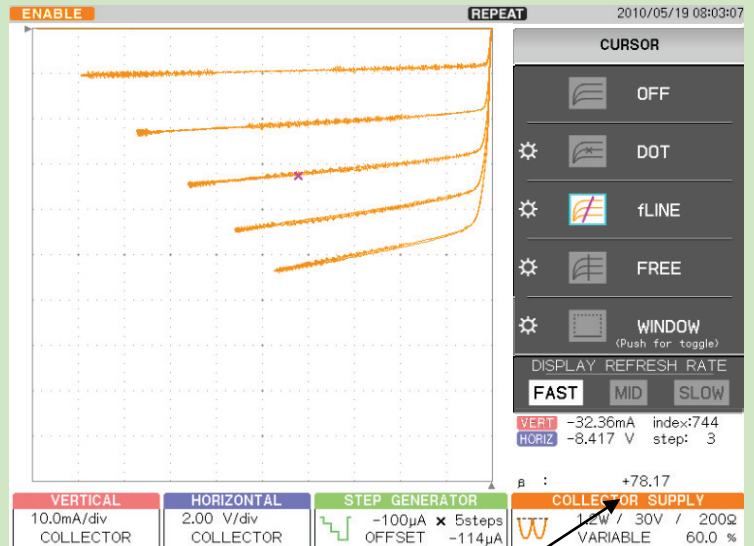

DC current amplification factor β of transistor: +78.17

Extracts from transistor performance table

Absolute max. rating

Voltage between collector/base V_{CBO}	-50 V
Voltage between collector/emitter V_{CEO}	-50 V
Voltage between emitter/base V_{EBO}	-5 V
Collector current I_C	-150 mA
Base current I_B	-50 mA
Collector loss P_C	400 mW

Electric characteristics

Item	Measurement Conditions	Measurement value/standard
DC current amplification factor	$V_{CE} = -6$ V $I_C = -100$ mA	70 to 400

Connection diagram

Connect the collector/base/emitter terminals of a transistor to the collector/base/emitter terminals of the test adapter. For connection between the test fixture and main unit, see Section 3.3.2.

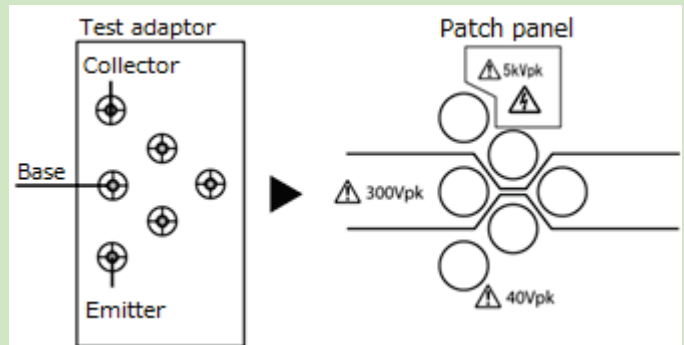

Caution! When starting or finishing measurement, operate CS-5000 as shown below:

- ◆ When starting measurement, set HIGH VOLTAGE breaker to DISABLED and open the test fixture.
- ◆ After connecting a measured device, set HIGH VOLTAGE breaker to ENABLED.
- ◆ After finishing measurement, rotate VARIABLE counterclockwise to set the value to 0% (to discharge applied voltage).
- ◆ Set HIGH VOLTAGE breaker to DISABLED.

■ Measurement procedure

After step (19) in Section 4.1.2.1, I_C vs. V_{CE} characteristics is displayed.

- (1) Press CURSOR key.
- (2) Press F2 key on the right of the submenu "DOT."
- (3) Rotate FUNCTION knob to move DOT to an arbitrary measurement point.

To move the cursor position (index), press FUNCTION knob.

VERT (current) value and HORIZ (voltage) value at the cursor position (index) are displayed.

β =DC current amplification factor (h_{FE})

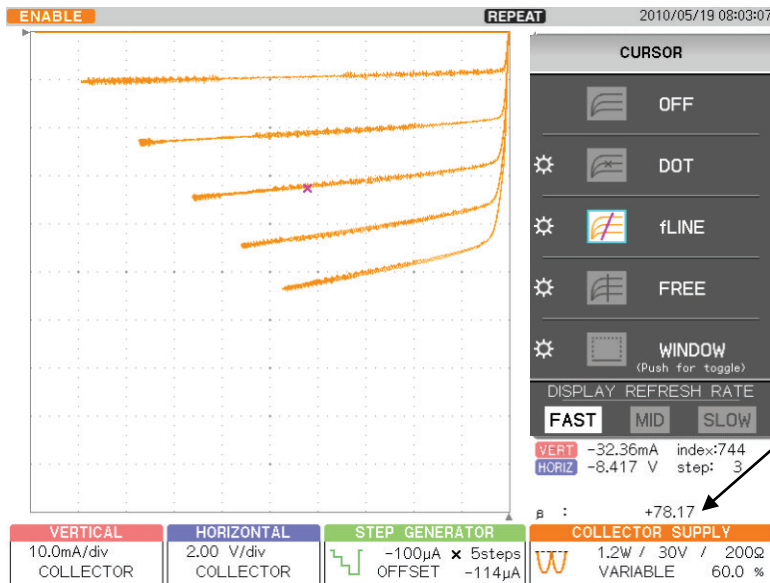

β =DC current amplification factor (h_{FE})

4.1.2.3 I_C vs. V_{BE} characteristics

It explains the measurement procedure of I_C vs. V_{BE} characteristics under the same conditions as "Section 4.1.2.1 I_C vs. V_{CE} characteristics," based on the extracts from the performance table for PNP transistors.

The diagram on the right in this frame shows the measurement result of I_C vs. V_{BE} characteristics of a transistor based on the extracts from the transistor performance table below.

In addition, extracts from the performance table of device characteristics which should be investigated in advance and the connection diagram indicating how to connect a measured device to the attached test adapter are shown.

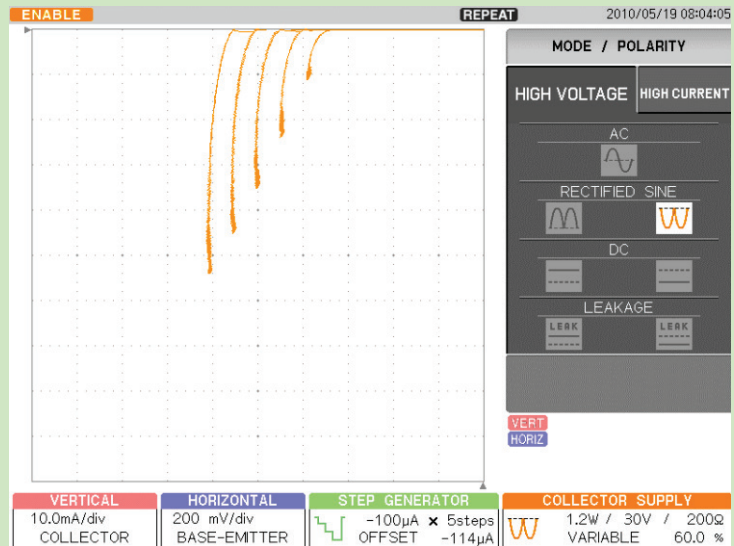

I_C vs. V_{BE} characteristics of transistor

Extracts from transistor performance table

Absolute max. rating		
Voltage between collector/base V_{CBO}		-50 V
Voltage between collector/emitter V_{CEO}		-50 V
Voltage between emitter/base V_{EBO}		-5 V
Collector current I_C		-150 mA
Base current I_B		-50 mA
Collector loss P_C		400 mW
Electric characteristics		
Item	Measurement conditions	Measurement value/standard
DC current amplification factor	$V_{CE} = -6$ V	70-400
	$I_C = -100$ mA	

Connection diagram

Connect the collector/base/emitter terminals of a transistor to the collector/base/emitter terminals of the test adapter. For connection between the test fixture and main unit, see Section 3.3.2.

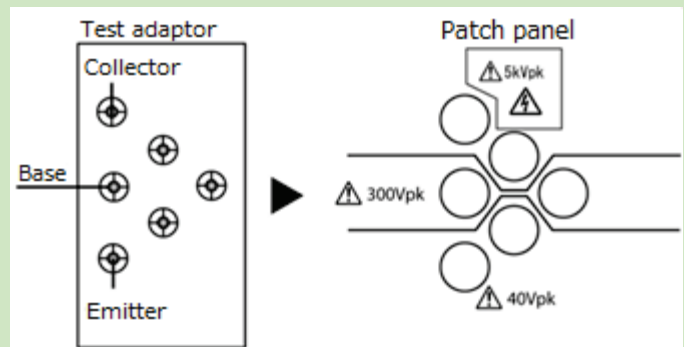

Caution! When starting or finishing measurement, operate CS-5000 as shown below:

- ◆ When starting measurement, set HIGH VOLTAGE breaker to DISABLED and open the test fixture.
- ◆ After connecting a measured device, set HIGH VOLTAGE breaker to ENABLED.
- ◆ After finishing measurement, rotate VARIABLE counterclockwise to set the value to 0% (to discharge applied voltage).
- ◆ Set HIGH VOLTAGE breaker to DISABLED.

■ Measurement procedure

After step (19) in Section 4.1.2.1, I_C vs. V_{CE} characteristics is displayed.

(1) Set HORIZONTAL range to 500mV and BASE-EMITTER.

For the base current, the collector current vs. the voltage characteristics between collector/emitter is displayed.

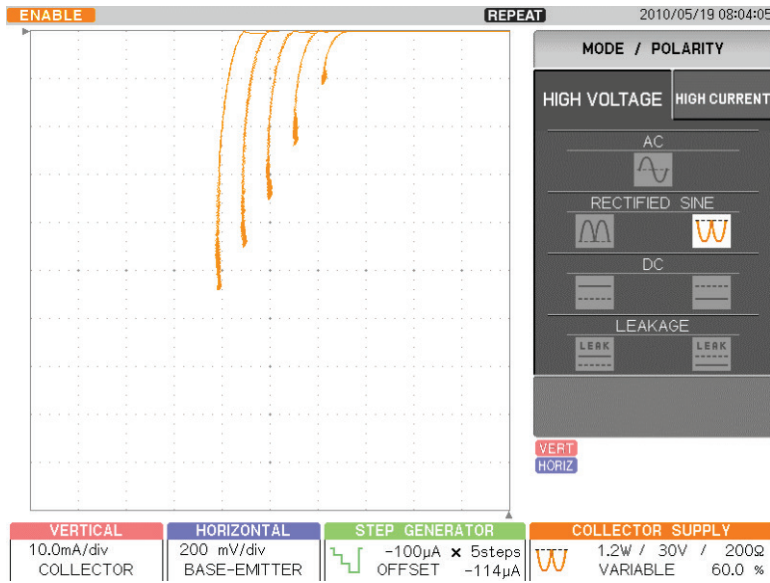

4.1.2.4 I_C vs. I_B characteristics

It explains the measurement procedure of I_C vs. I_B characteristics under the same conditions as "Section 4.1.2.1 I_C vs. V_{CE} characteristics," based on the extracts from the performance table for PNP transistors.

The diagram on the right in this frame shows the measurement result of I_C vs. I_B characteristics of a transistor based on the extracts from the transistor performance table below.

In addition, extracts from the performance table of device characteristics which should be investigated in advance and the connection diagram indicating how to connect a measured device to the attached test adapter are shown.

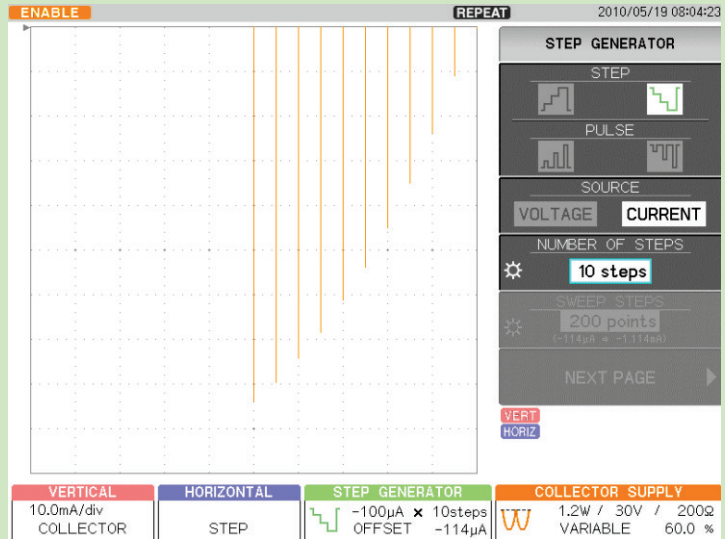

I_C vs. I_B characteristics of transistor

Extracts from transistor performance table

Absolute max. rating		
Voltage between collector/base V_{CBO}		-50 V
Voltage between collector/emitter V_{CEO}		-50 V
Voltage between emitter/base V_{EBO}		-5 V
Collector current I_C		-150 mA
Base current I_B		-50 mA
Collector loss P_C		400 mW
Electric characteristics		
Item	Measurement conditions	Measurement value/standard
DC current amplification factor	$V_{CE}=-6$ V $I_C=-100$ mA	70 to 400

Connection diagram

Connect the collector/base/emitter terminals of a transistor to the collector/base/emitter terminals of the test adapter. For connection between the test fixture and main unit, see Section 3.3.2.

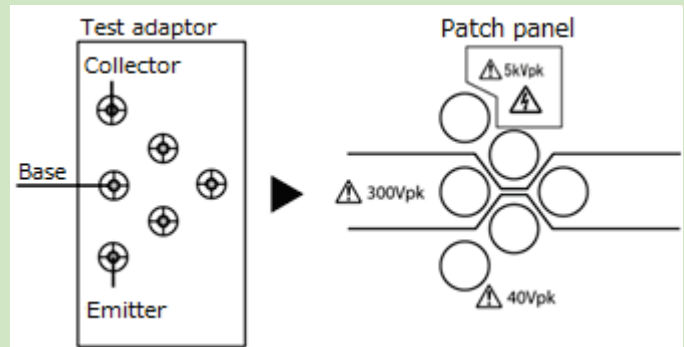

Caution! When starting or finishing measurement, operate CS-5000 as shown below:

- ◆ When starting measurement, set HIGH VOLTAGE breaker to DISABLED and open the test fixture.
- ◆ After connecting a measured device, set HIGH VOLTAGE breaker to ENABLED.
- ◆ After finishing measurement, rotate VARIABLE counterclockwise to set the value to 0% (to discharge applied voltage).
- ◆ Set HIGH VOLTAGE breaker to DISABLED.

■ Measurement procedure

After step (19) in Section 4.1.2.1, I_C vs. V_{CE} characteristics is displayed.

- (1) Rotate HORIZONTAL range counterclockwise and set to STEP.
- (2) Press STEP GENERATOR MENU key.
- (3) Rotate FUNCTION knob to set NUMBER OF STEPS to 10.

The characteristics of the collector current vs. the base current are displayed with one horizontal division equal to one step.

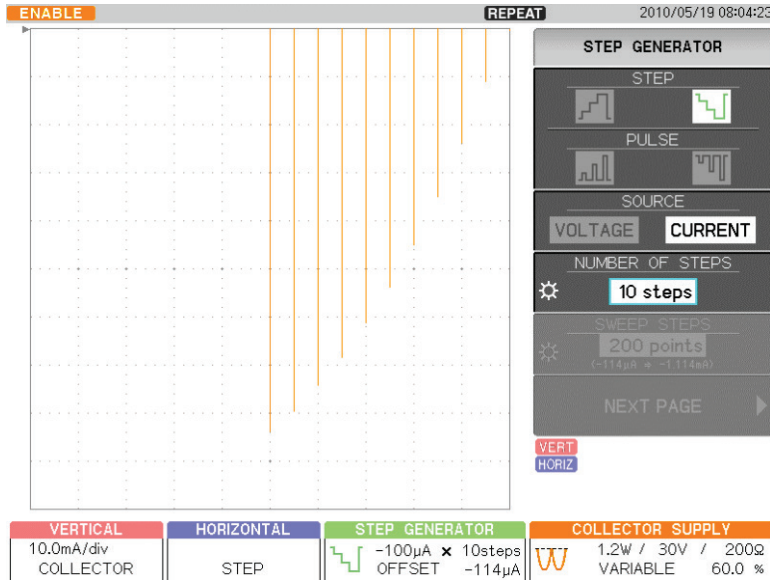

4.1.2.5 I_B vs. V_{CE} characteristics

It explains the measurement procedure of I_B vs. V_{CE} characteristics under the same conditions as "Section 4.1.2.1 I_C vs. V_{CE} characteristics," based on the extracts from the performance table for PNP transistors.

The diagram on the right in this frame shows the measurement result of I_B vs. V_{CE} characteristics of a transistor based on the extracts from the transistor performance table below.

In addition, extracts from the performance table of device characteristics which should be investigated in advance and the connection diagram indicating how to connect a measured device to the attached test adapter are shown.

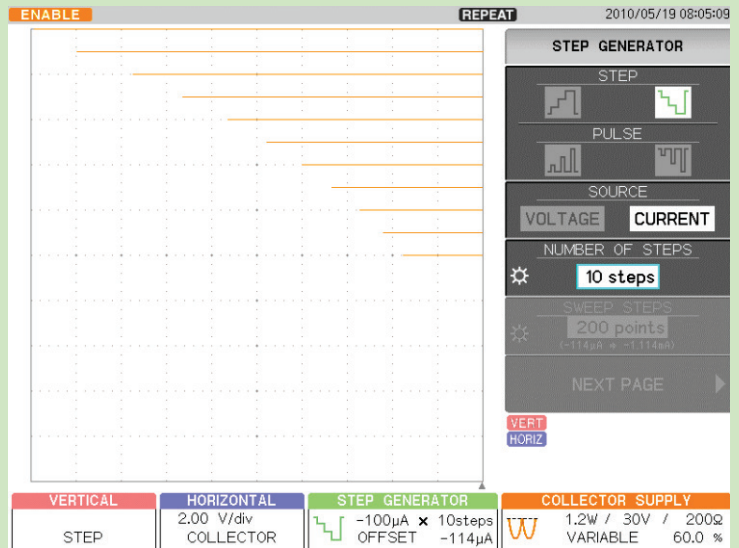

I_B vs. V_{CE} characteristics of transistor

Extracts from transistor performance table

Absolute max. rating

Voltage between collector/base V_{CBO}	-50 V
Voltage between collector/emitter V_{CEO}	-50 V
Voltage between emitter/base V_{EBO}	-5 V
Collector current I_C	-150 mA
Base current I_B	-50 mA
Collector loss P_C	400 mW

Electric characteristics

Item	Measurement conditions	Measurement value/standard
DC current amplification factor	$V_{CE} = -6$ V $I_C = -100$ mA	70 to 400

Connection diagram

Connect the collector/base/emitter terminals of a transistor to the collector/base/emitter terminals of the test adapter. For connection between the test fixture and main unit, see Section 3.3.2.

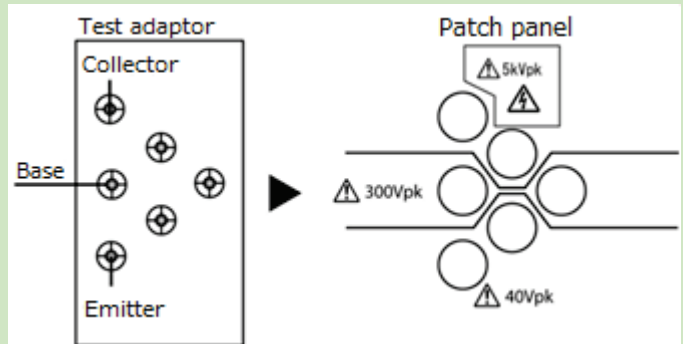

Caution! When starting or finishing measurement, operate CS-5000 as shown below:

- ◆ When starting measurement, set HIGH VOLTAGE breaker to DISABLED and open the test fixture.
- ◆ After connecting a measured device, set HIGH VOLTAGE breaker to ENABLED.
- ◆ After finishing measurement, rotate VARIABLE counterclockwise to set the value to 0% (to discharge applied voltage).
- ◆ Set HIGH VOLTAGE breaker to DISABLED.

■ Measurement procedure

After step (19) in Section 4.1.2.1, I_C vs. V_{CE} characteristics is displayed.

- (1) Rotate VERTICAL range counterclockwise to set to STEP.
- (2) Rotate HORIZONTAL range clockwise to set to 2.00 V/div and COLLECTOR.
- (3) Press STEP GENERATOR MENU key.
- (4) Rotate FUNCTION knob to set NUMBER OF STEPS to 10.

The characteristics of the base current vs. the voltage between collector/emitter are displayed with vertical 0.5div equal to one step.

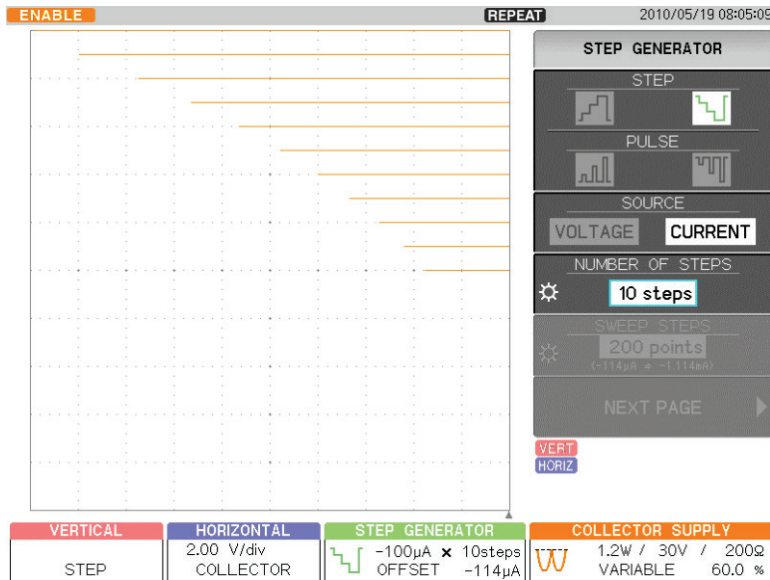

4.1.3 FET measurement

This section shows examples of measurement for I_D vs. V_{DS} characteristics based on the performance table for N-channel junction FET. The examples include measurement which obtains each parameter of ON resistance of drain_source and transconductance (gm) using the cursor, based on the measurement results. In addition, the examples include measurement for I_D vs. V_{GS} characteristics and the forward transfer admittance under the same conditions and in the different mode.

4.1.3.1 I_D vs. V_{DS} characteristics

4.1.3.2 Measurement of I_D vs. V_{DS} characteristics, ON resistance of drain_source, and transconductance (gm)

4.1.3.3 I_D vs. V_{GS} characteristics and forward transfer admittance

4.1.3.1 I_D vs. V_{DS} measurement

It explains the measurement procedure for I_D vs. V_{DS} characteristics of FET.

The diagram on the right in this frame shows the measurement result of I_D vs. V_{DS} characteristics of a FET based on the extracts from the FET performance table below.

In addition, extracts from the performance table of device characteristics which should be investigated in advance and the connection diagram indicating how to connect a measured device to the attached test adapter are shown.

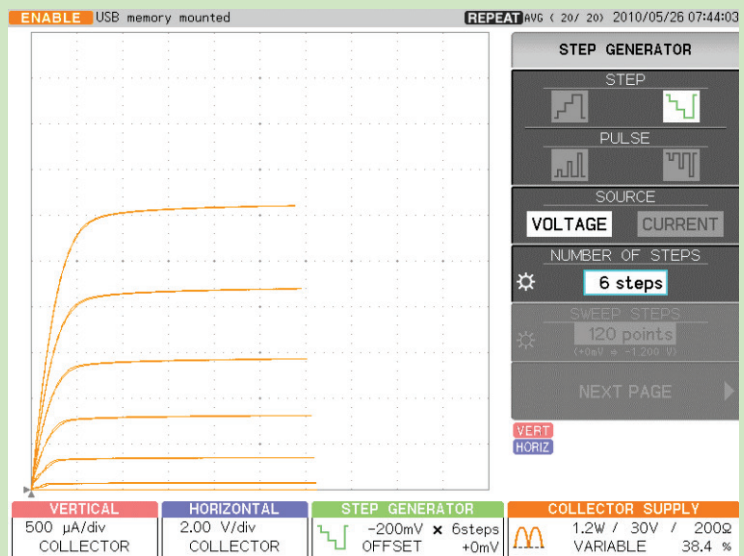

I_D vs. V_{DS} characteristics of source-grounded FET

Extracts from FET performance table

Absolute max. rating		
Voltage between gate/drain V_{GDS}		-50 V
Gate current I_G		10 mA
Permissible loss P_D		150 mW

Electric characteristics

Item	Measurement conditions	Measurement value/min.
Drain current I_{DS}	$V_{DS} = -10$ V $V_{GS} = 0$ V	0.3-6.5mA

Connection diagram

Connect the drain/gate/source terminals of a FET to the collector/base/emitter terminals of the test adapter. For connection between the test fixture and unit main, see Section 3.3.2.

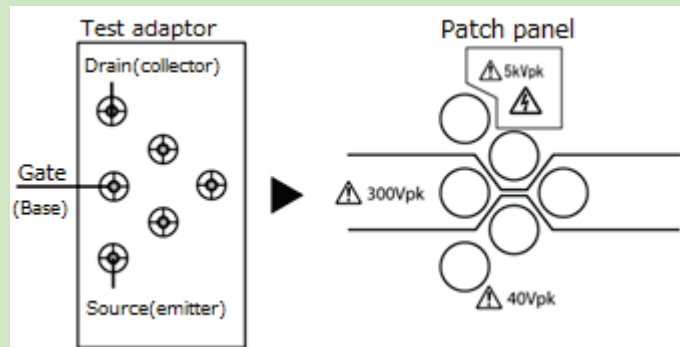

Caution! When starting or finishing measurement, operate CS-5000 as shown below:

- ◆ When starting measurement, set HIGH VOLTAGE breaker to DISABLED and open the test fixture.
- ◆ After connecting a measured device, set HIGH VOLTAGE breaker to ENABLED.
- ◆ After finishing measurement, rotate VARIABLE counterclockwise to set the value to 0% (to discharge applied voltage).
- ◆ Set HIGH VOLTAGE breaker to DISABLED.

■ Measurement procedure

- (1) Press MAX PEAK POWER- WATTS key.
- (2) Press F4 key and set to 1.20 W.
Collector loss =150 mW in accordance with the performance table.
- (3) Press MAX PEAK VOLTAS key.
- (4) Press F3 key and set to 30V.
Measurement condition $V_{DS}=10\text{ V}$ in accordance with the performance table.

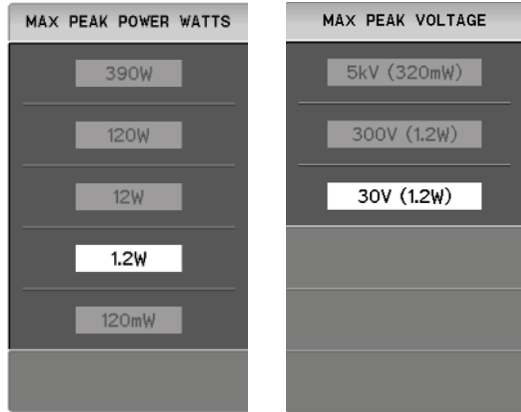

- (5) Press CONFIGURATION key.
- (6) Press F1 key. Set to Collector/StepGen/Common.

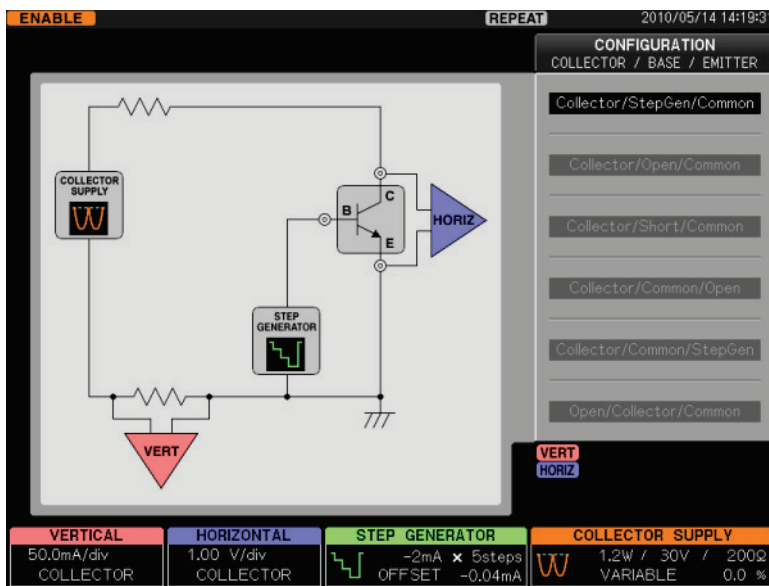

- (7) Press STEP GENERATOR MENU key.
- (8) Press F1 key to select "-STEP."
- (9) Press F3 key to select "VOLTAGE."
FET: voltage bias
- (10) Rotate FUNCTION knob to set NUMBER OF STEPS to 6.

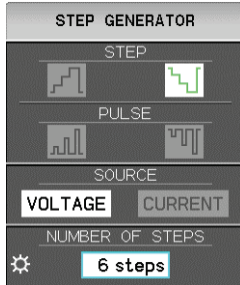

- (11) Rotate STEP AMPLITUDE knob to set to -200 mV/div .
Measurement condition ($V_{DS} = -10 \text{ V}$, $V_{GS} = 0 \text{ V}$), $V_{GS} = 0 \text{ V}$ at $-200 \text{ mV} \times 5$ step, in accordance with the performance table.
Range of measured drain current I_{DSS} at this time: 0.3 to 6.5 mA
- (12) Press OFFSET knob to set OFFSET to 0.
- (13) Press MODE/POLARITY key.
- (14) Press F1 key and set to HIGH VOLTAGE.
- (15) Press F3 key and set RECTIFIED SINE to "+" (+full-wave rectified).

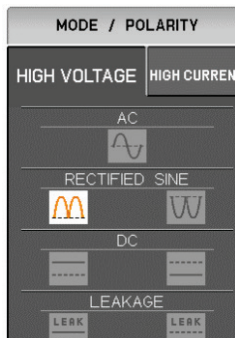

- (16) Set VERTICAL to $500 \mu\text{A/div}$ and COLLECTOR.
Drain current $I_{DSS} = -0.3$ to 6.5 mA in accordance with the performance table.
Make proper setting in accordance with device measurement value.
- (17) Set HORIZONTAL to 2.00 V/div and COLLECTOR.
 5 div. on screen equal to 2.00 V setting under measurement condition $V_{DS} = 10 \text{ V}$ in accordance with the performance table.

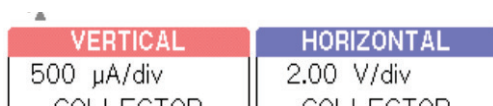

I_D vs. V_{GS} characteristics

- (18) Set HIGH VOLTAGE breaker to ENABLED.
- (19) Gradually rotate VARIABLE clockwise to apply a voltage to the device.

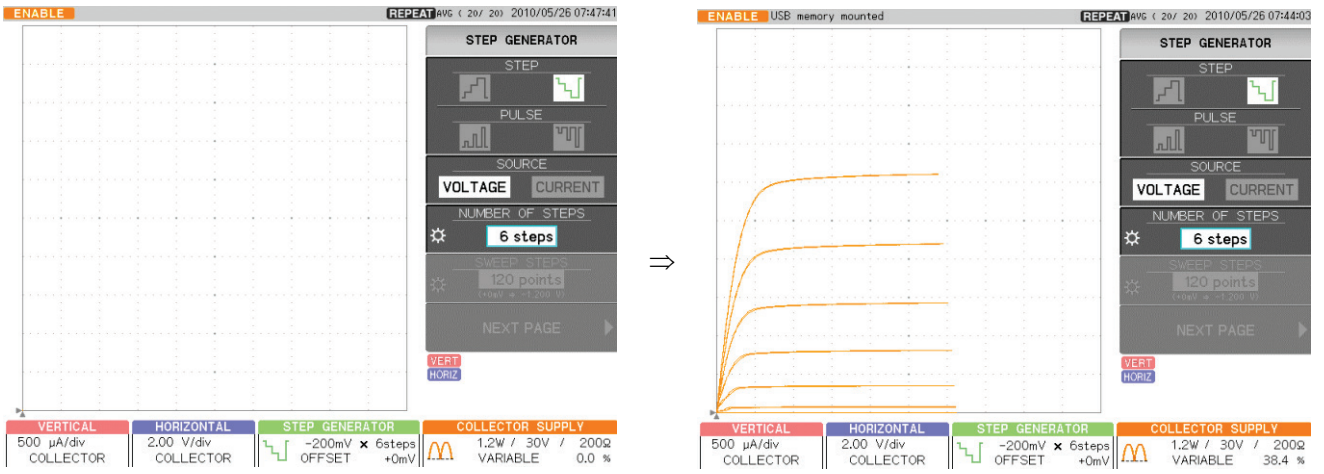

4.1.3.2 Measurement of I_D vs. V_{DS} characteristics, ON resistance of drain_source, and transconductance (g_m)

It shows examples of measurement which obtains each parameter of ON resistance of drain_source and transconductance (g_m) of N-channel FET under the same conditions as Section 4.1.3.1 " I_D vs. V_{DS} characteristics."

The diagram on the right in this frame shows the measurement result of the transconductance (g_m) of a FET based on the extracts from the FET performance table below. ON resistance of drain_source is described in measurement step (6).

In addition, extracts from the performance table of device characteristics which should be investigated in advance and the connection diagram indicating how to connect a measured device to the attached test adapter are shown.

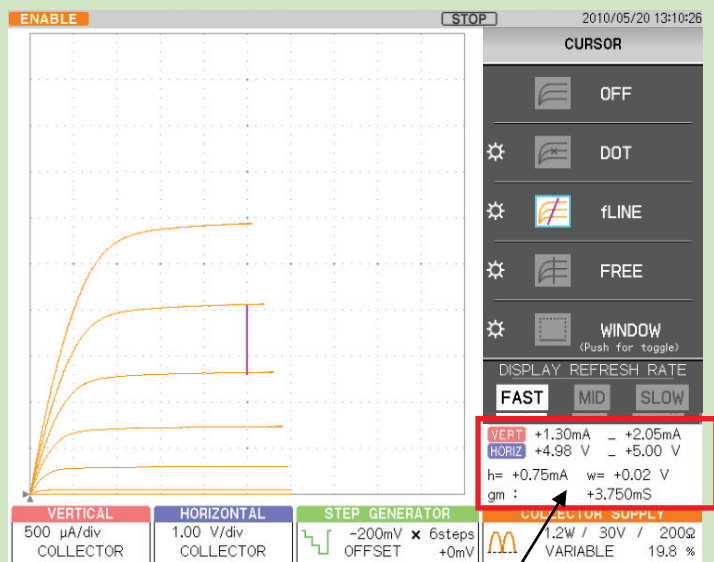

Transconductance (g_m) of FET

Extracts from FET performance table

Absolute max. rating		
Voltage between gate/drain V_{GDS}	-50 V	
Gate current I_G	10 mA	
Permissible loss P_D	150 mW	

Electric characteristics

Item	Measurement conditions	Measurement value/ min.
Drain current I_{DS}	$V_{DS} = -10 V$ $V_{GS} = 0 V$	0.3 to 6.5mA

Connection diagram

Connect the drain/gate/source terminals of a FET to the collector/base/emitter terminals of the test adapter. For connection between the test fixture and main unit, see Section 3.3.2.

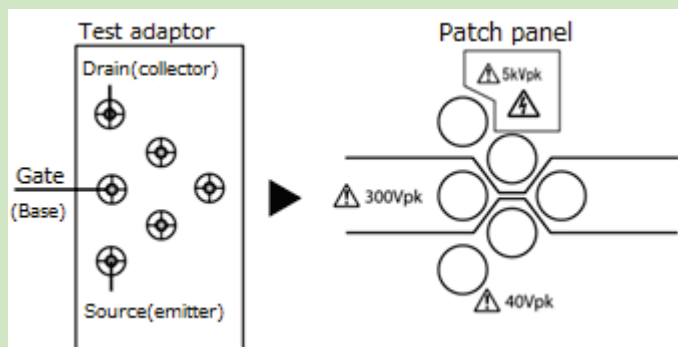

Caution! When starting or finishing measurement, operate CS-5000 as shown below:

- ◆ When starting measurement, set HIGH VOLTAGE breaker to DISABLED and open the test fixture.
- ◆ After connecting a measured device, set HIGH VOLTAGE breaker to ENABLED.
- ◆ After finishing measurement, rotate VARIABLE counterclockwise to set the value to 0% (to discharge applied voltage).
- ◆ Set HIGH VOLTAGE breaker to DISABLED.

■ Measurement procedure

After step (19) in Section 4.1.3.1, I_D vs. V_{DS} characteristics is displayed.



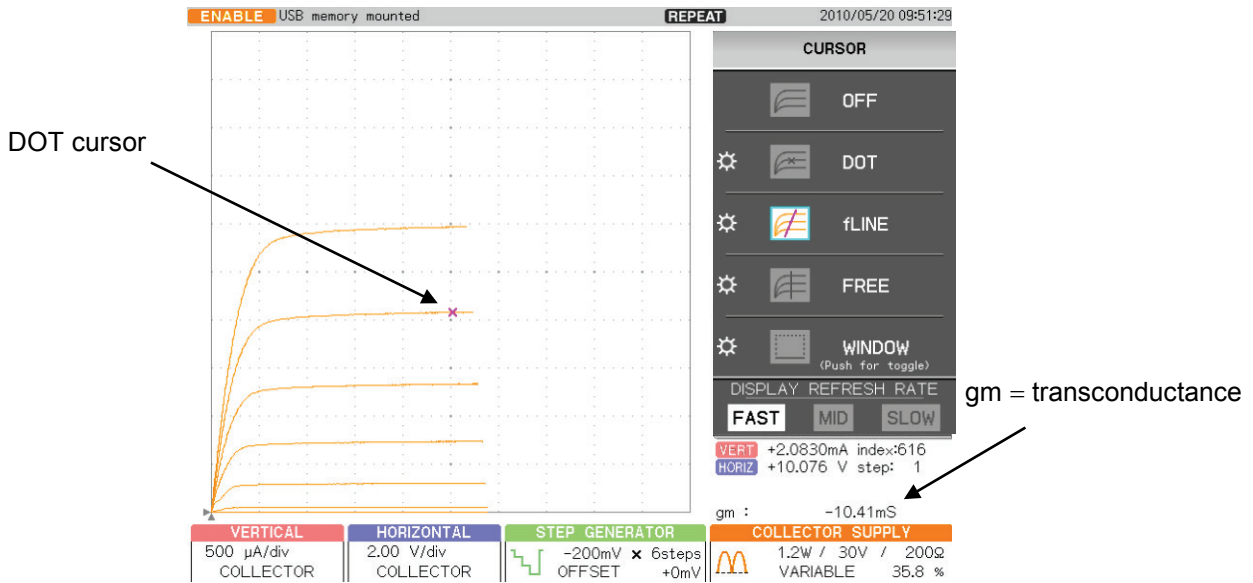

- (1) Press CURSOR key.
- (2) Press F2 key on the right of the submenu "DOT."
- (3) Rotate FUNCTION knob to move DOT to an arbitrary measurement point.
To move the cursor position (index), press FUNCTION knob.
VERT (current) value and HORIZ (voltage) value at the cursor position (index) are displayed.
 g_m = transconductance as the result of cursor measurement is displayed on the lower part of the screen.

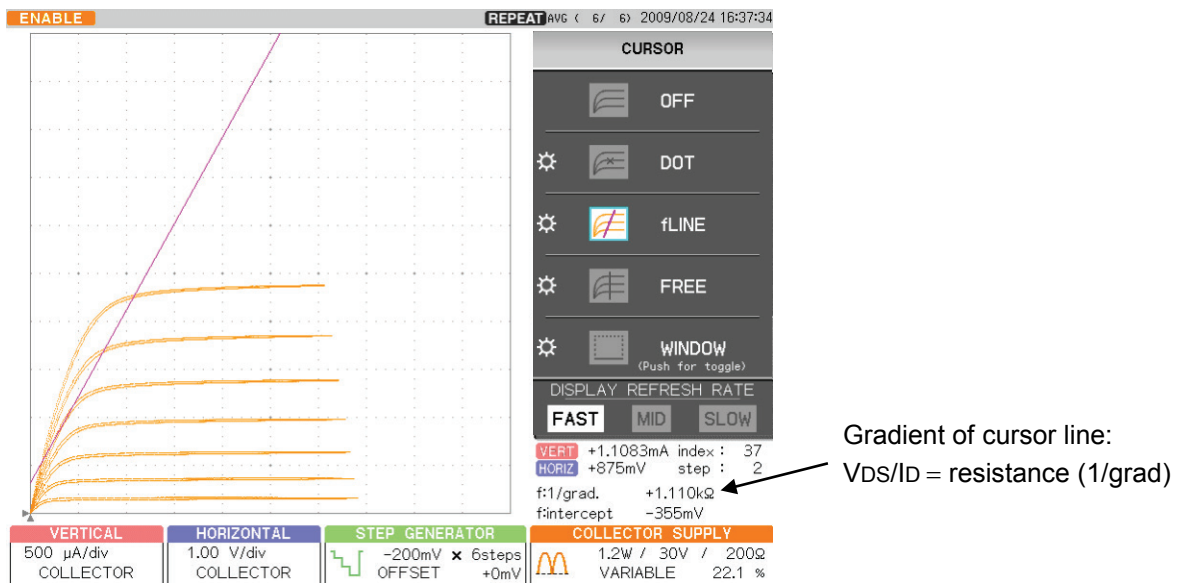

- (4) Rotate FUNCTION knob to move DOT to an arbitrary measurement point (ON resistance).
- (5) On the cursor menu, press F3 on the right of the submenu "fLINE."
- (6) Rotate FUNCTION knob so that the gradient of fLINE cursor is tangential to the characteristics curve.
ON resistance value for FET at the arbitrary measurement point (position: index) is displayed in the readout of CURSOR (f:1/grad).



- (6) On the cursor menu, press F4 key on the right of the submenu "WINDOW."
The rectangular cursor appears.
- (7) Push F4 key or FUNCTION knob to switch the side to be moved in sequence.

Upper  → left  → lower  → right 



The selected side is displayed.

- (8) Rotate FUNCTION knob to move the selected side vertically or horizontally.
Measure gm in one step.

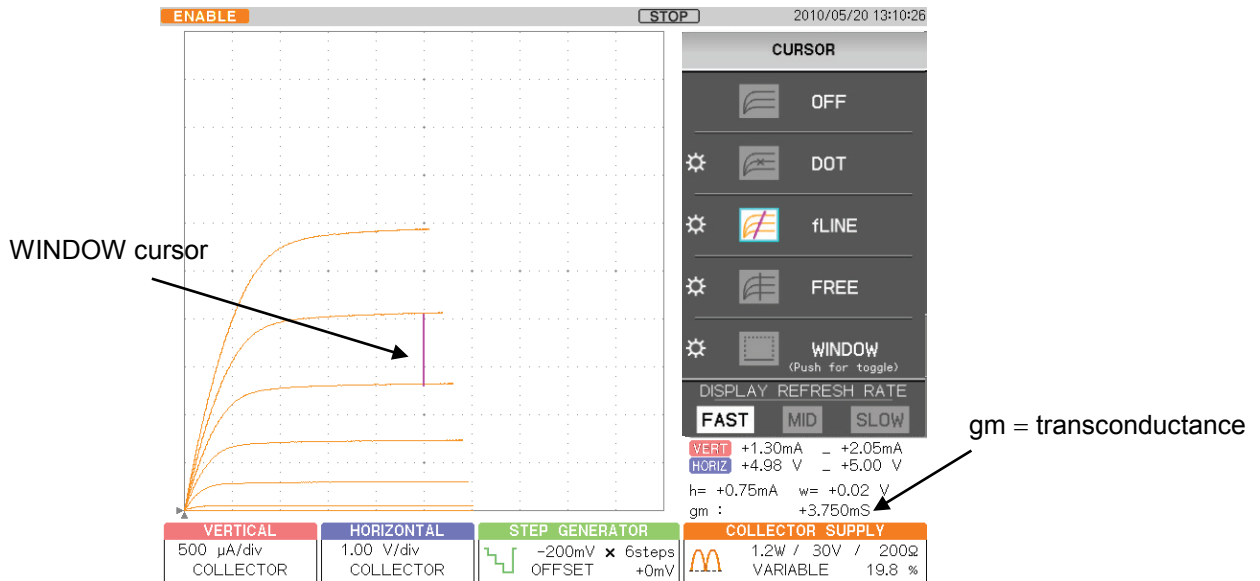

4.1.3.3 I_D vs. V_{GS} characteristics and forward transfer admittance

It shows examples of SWEEP measurement which obtains the forward transfer admittance of N-channel FET under the same conditions as "Section 4.1.3.1 I_D vs. V_{DS} characteristics."

The diagram on the right in this frame shows the measurement result of the forward transfer admittance of a FET which is SWEEP-measured based on the extracts from the FET performance table below.

For details of SWEEP measurement, see Section 3.8.

In addition, extracts from the performance table of device characteristics which should be investigated in advance and the connection diagram indicating how to connect a measured device to the attached test adaptor are shown.



Forward transfer admittance of FET: +2.871mS

Extracts from FET performance table

Absolute max. rating		
Voltage between gate/drain V_{GDS}		-50 V
Gate current I_G		10 mA
Permissible loss P_D		150 mW
Electric characteristics		
Item	Measurement conditions	Measurement value
Drain current I_{DS}	$V_{DS} = -10$ V	0.3 to 6.5mA
Forward transfer admittance	$V_{GS} = 0$ V	1.2 mS
	$V_{DS} = 10$ V	
	$V_{GS} = 0$ V	

Connection diagram

Connect the drain/gate/source terminals of a FET to the collector/base/emitter terminals of the test adaptor. For connection between the test fixture and main unit, see Section 3.3.2.

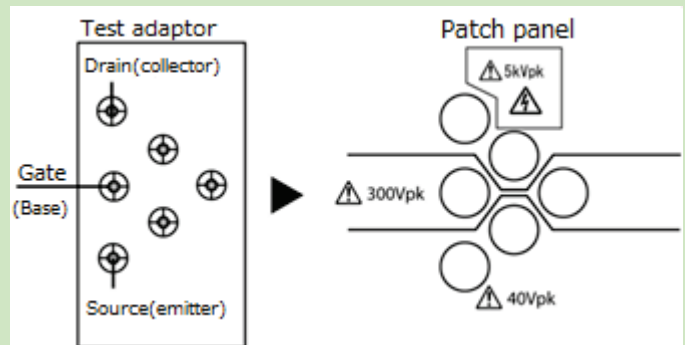

Caution! When starting or finishing measurement, operate CS-5000 as shown below:

- ◆ When starting measurement, set HIGH VOLTAGE breaker to DISABLED and open the test fixture.
- ◆ After connecting a measured device, set HIGH VOLTAGE breaker to ENABLED.
- ◆ After finishing measurement, rotate VARIABLE counterclockwise to set the value to 0% (to discharge applied voltage).
- ◆ Set HIGH VOLTAGE breaker to DISABLED.

■ Measurement procedure

After step (9) of Section 4.1.3.1,

Set the measurement conditions for forward transfer admittance: V_{DS}, V_{GS}

- (1) Rotate FUNCTION knob to set NUMBER OF STEPS to 0.

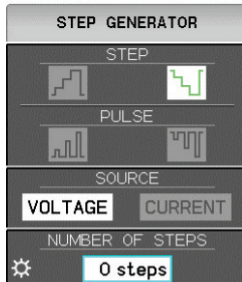

- (2) Press OFFSET knob to set OFFSET to 0.
- (3) Press MODE/POLARITY key.
- (4) Press F1 key and set to HIGH VOLTAGE.
- (5) Press F3 key and set RECTIFIED SINE to "+ (+ full-wave rectified)".

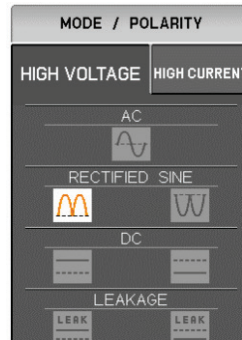

- (7) Set VERTICAL to 500 $\mu\text{A}/\text{div}$ and COLLECTOR.
- (8) Set HORIZONTAL range to 2.00 V/div and COLLECTOR.
- (9) Gradually rotate VARIABLE to set the collector voltage to the measurement condition V_{DS} in the performance table.
- (10) Press CURSOR key.
- (11) Press F2 key on the right of the submenu "DOT."
- (12) Rotate FUNCTION knob to make DOT equal to the measurement condition V_{DS} in the performance table.

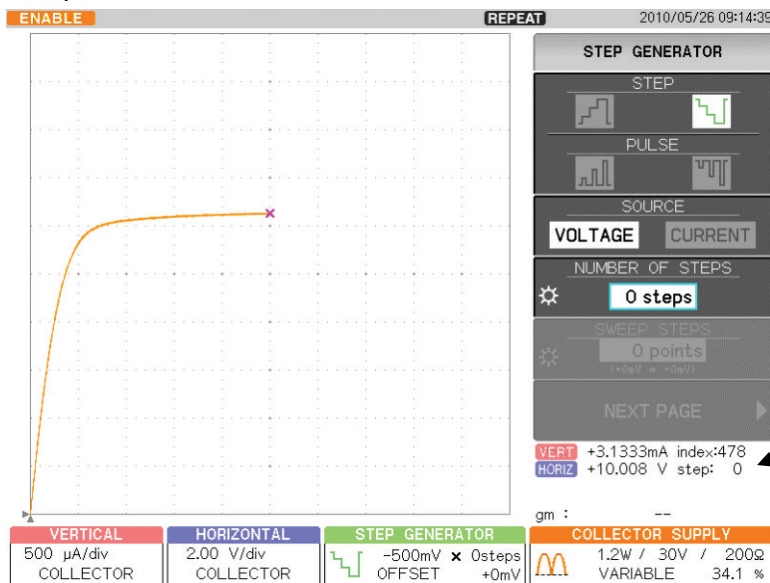

Check measurement condition V_{DS} in the performance table.

Setting SWEEP measurement

- (13) Set STEP GENERATOR to -PULSE.
- (14) Rotate STEP AMPLITUDE knob to set to -500 mV/div.
In accordance with I_D - V_{DS} characteristics in the performance table.
- (15) Set COLLECTOR to BASE-EMITTER 500 mV/div.
- (16) Set NUMBER OF STEPS to 5 steps (SWEEP STEPS=100 points).
- (17) Press SWEEP key.

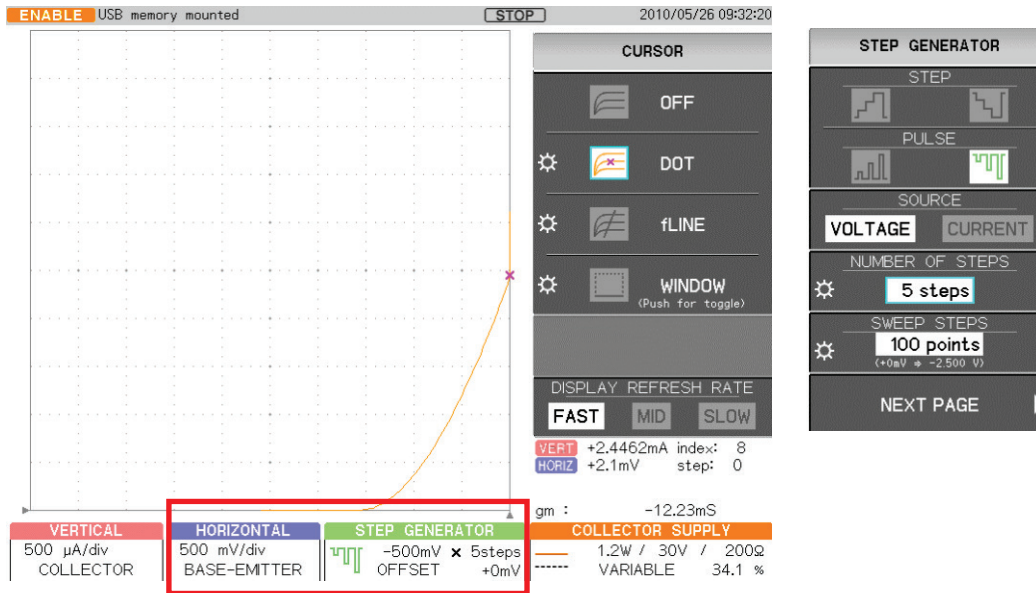

- (18) Rotate FUNCTION knob and move DOT to the measurement condition $V_{GS}=0V$ of the performance table.
- (19) On the cursor menu, press F3 key on the right of the submenu "fLINE".
- (20) Rotate FUNCTION knob to make gradient of fLINE cursor consistent with the tangent direction of the characteristics curve.
The forward transfer admittance of FET at the measurement point (position index=8) is displayed in the readout of CURSOR (f:1/grad).

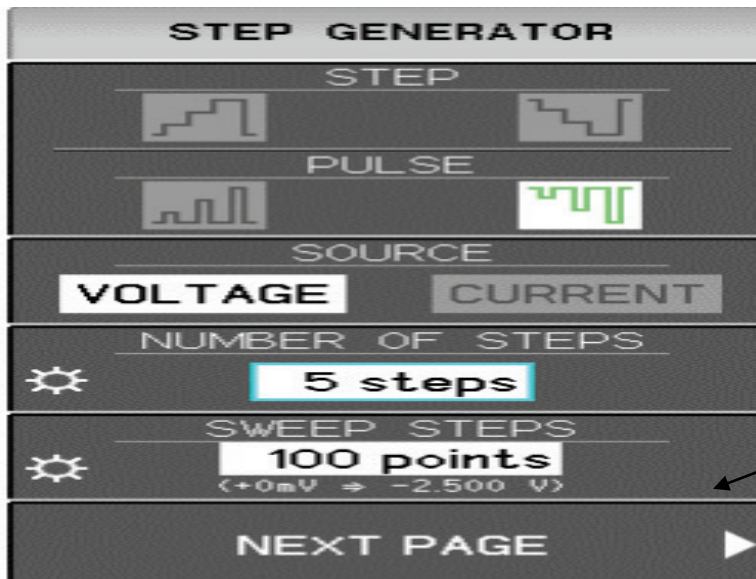

Forward transfer admittance
+2.871mS

4.2 Characteristics measurement

4.2.1 IGBT characteristics measurement

This section shows examples of measurement for the saturation voltage V_{CES} between collector/emitter of IGBT and the forward voltage (V_{FM}) Peak Forward Voltage Drop in HIGH CURRENT (large current) mode.

The diagram on the right in this frame shows the measurement result of the saturation voltage between collector/emitter V_{CES} of an IGBT based on the extracts from the IGBT performance table below. In addition, extracts from the performance table of device characteristics which should be investigated in advance is shown. For connection method, see the connection diagram on the next page.

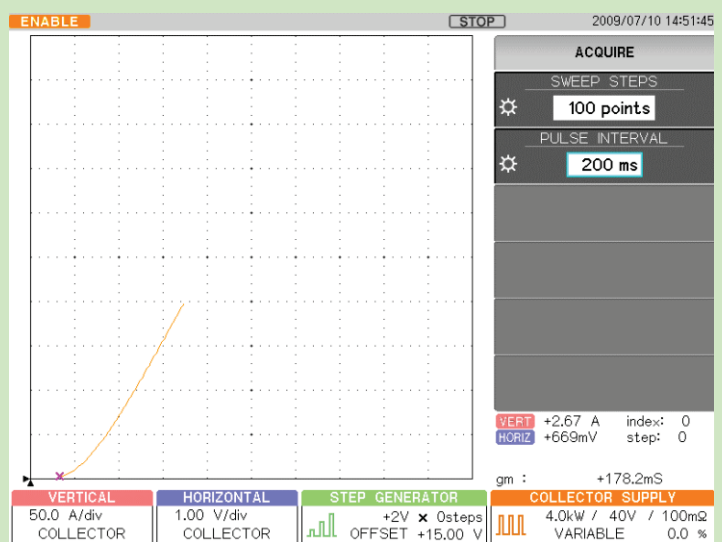

Saturation voltage V_{CES} between collector/emitter of IGBT

Extracts from N-channel IGBT performance table

Absolute max. rating

Voltage between collector/emitter V_{CES} 3.300 V

Voltage between gate/emitter V_{GES} ± 20 V

Electric characteristics

Item Saturation voltage between collector/emitter V_{CES}

Measurement conditions $I_C=400$ A, $V_{GE}=15$ V

Measurement value 4.2 V

Item Forward voltage V_{FM}

Measurement condition $I_C=400$ A, $V_{GE}=0$ V

Measurement value 2.5 V

Caution! When starting or finishing measurement, operate CS-5000 as shown below:

- ◆ When starting measurement, set HIGH VOLTAGE breaker to DISABLED and open the test fixture.
- ◆ After connecting a measured device, set HIGH VOLTAGE breaker to ENABLED.
- ◆ After finishing measurement, rotate VARIABLE counterclockwise to set the value to 0% (to discharge applied voltage).
- ◆ Set HIGH VOLTAGE breaker to DISABLED.

In connection diagram, connected procedure, and the measurement procedure of this example, it explains by the example that uses CS-5400 as the main unit, CS-304 as the test fixture.

Connection diagram

The diagram below shows how to directly connect a measured device to the test fixture. Connect the gate, emitter, and collector terminals of IGBT to the base, emitter, and collector terminals of the test fixture using the attached wires.

Caution!

- ◆ If SENSE of HIGH CURRENT is not connected, CS-5000 displays and measures nothing in HIGH CURRENT mode.
- ◆ To improve accuracy, connect the emitter sense.

Connection procedure

- (1) Remove the test adapter mounting part from the test fixture.
- (2) Set the measured device IGBT in it.
- (3) Connect the collector of the measured device IGBT to SENCE terminal, the emitter to SENCE terminal, and the gate terminal to 300Vpk, using the attached wires as shown below:

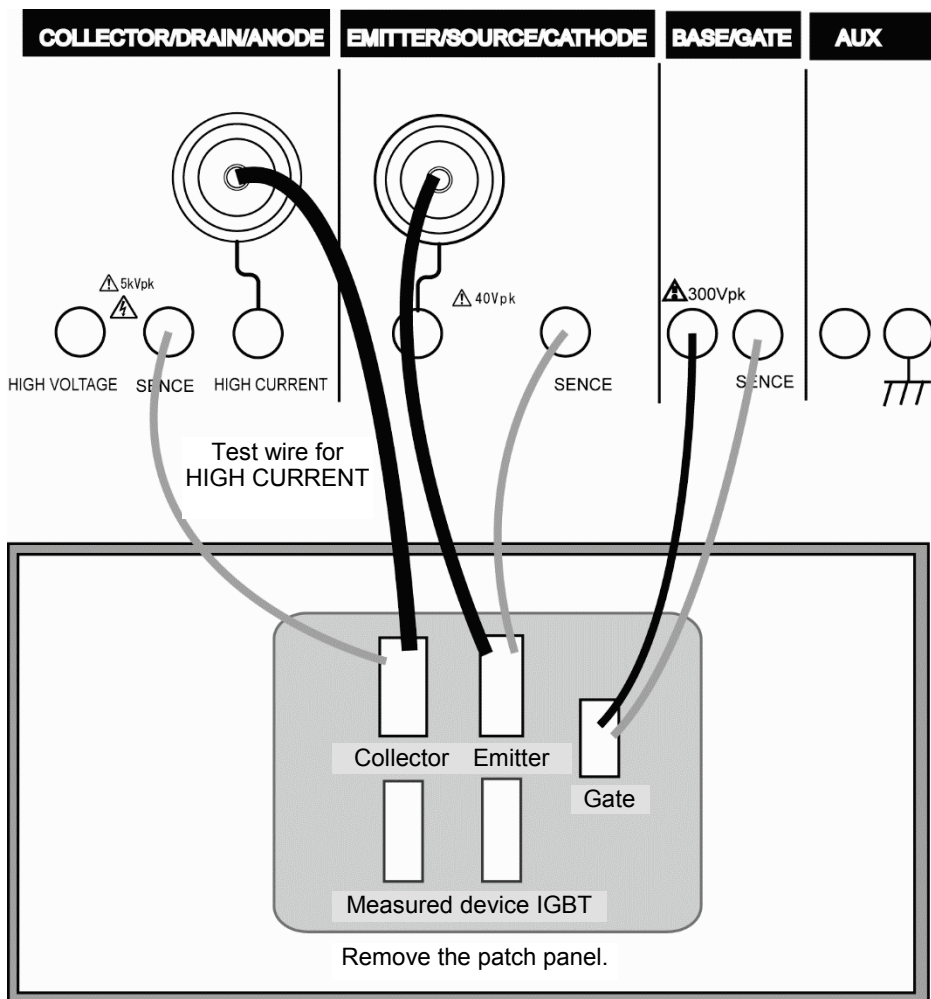

■ Measurement procedure

- (1) Press MODE/POLARITY key.
- (2) Press F1 key and set to HIGH CURRENT.
- (3) Press MAX PEAK POWER- WATTS key.
- (4) Press F2 key and set to the measurement condition 4.5kw (600A).
Measurement condition $I_c=400$ A in accordance with the performance table.
- (5) Press MAX PEAK VOLTAS key.
- (6) Press F3 key to check 30 V.

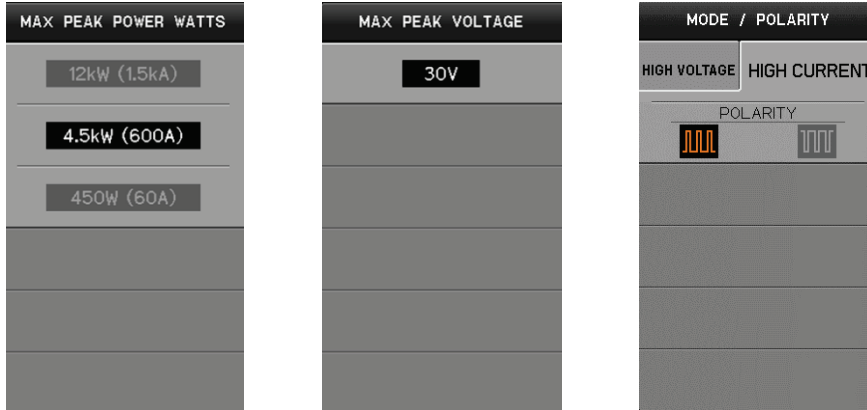

- (7) Press STEP GENERATOR MENU key.
- (8) Press F2 key to select +PULSE.
N-channel IGBT: plus bias
- (9) Press F3 key to select VOLTAGE.
- (10) Rotate FUNCTION knob and set NUMBER OF STEPS to 0.
- (11) Rotate STEP AMPLITUDE knob to set to 2V/div.
- (12) Rotate OFFSET knob to set the measurement condition V_{GE} .
Set the measurement condition V_{GE} in accordance with the performance table.

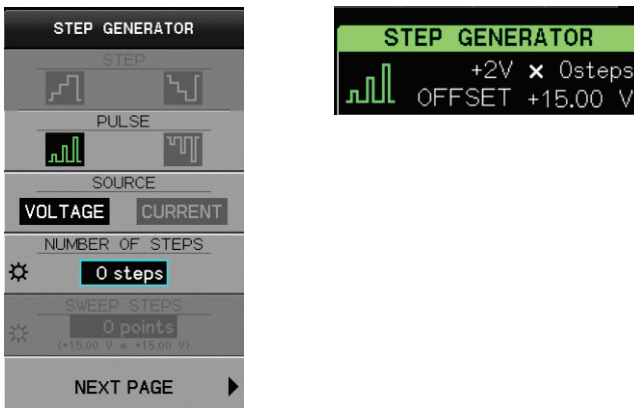

(13) Press CONFIGURATION key.

In HIGH CURRENT, the setting is fixed to Collector/StepGen/Common

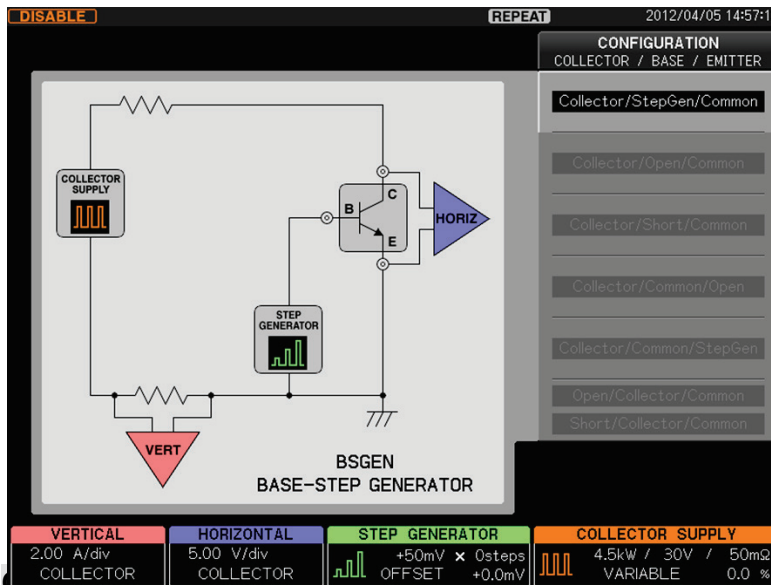

(14) Press VIEW/PULSE key.

(15) Press F1 key to set VIEW MODE to WAVE.

WAVE 1st

(16) Press F2 key to set to V_{ce} .

(17) Rotate FUNCTION knob to set V_{ce} range. Make proper setting in accordance with device measurement value.

WAVE 2nd

(18) Press FUNCTION knob to set to I_c .

(19) Rotate FUNCTION knob to set I_c range. Make proper setting in accordance with device measurement value.

(20) Set PULSE WIDTH to $400\mu s$. Make proper setting depending on the device.

(21) Set MEASUREMENT POINT to $300\mu s$. Make proper setting depending on the device.

(22) Move the cursor to the measurement point where waveforms of WAVE 1st and WAVE 2nd are stable.

Starting measurement

(23) Set HIGH CURRENT breaker to ENABLED.

(24) Gradually rotate VARIABLE and apply the current to the device.

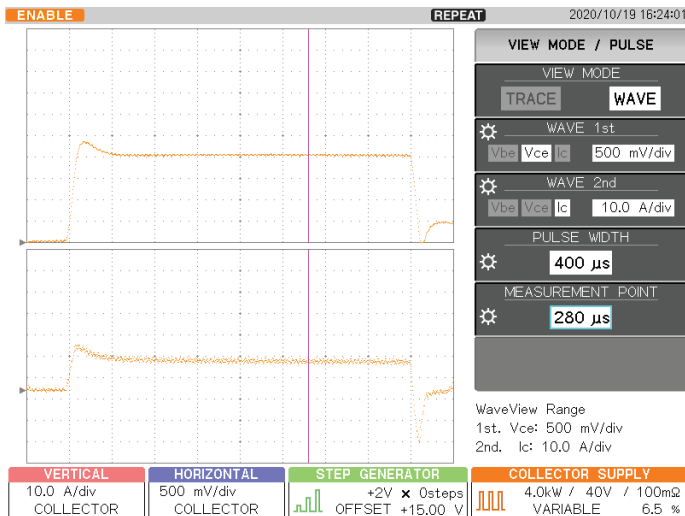

After checking WAVE waveform

(25) Press F1 key and set VIEW MODE to TRACE.

- (26) Press ACQUIRE key.
- (27) Press F1 key and rotate FUNCTION knob to set SWEEP STEPS.
- (28) Press F2 key and rotate FUNCTION knob to set PULSE INTERVAL.
- (29) Rotate VARIABLE key again and apply I_c to the device as required.
- (30) Press SWEEP key. (For SWEEP mode, see Section 3.8.)
- (31) Sweep the range from VARIABLE setting value to 0%.

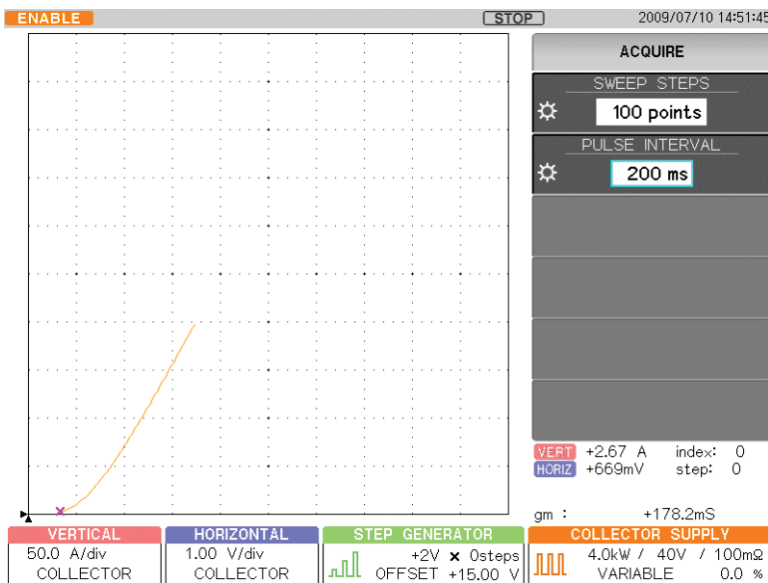
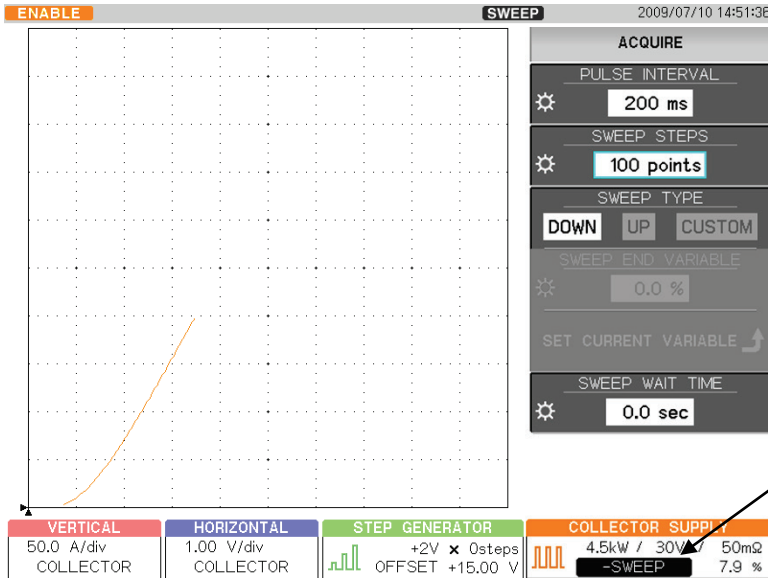

Saturation voltage V_{CES} between collector/emitter of IGBT

Measuring forward voltage V_{FM} (Peak Forward Voltage Drop)

- (32) Press OFFSET knob of STEP GENERATOR to set to 0 V.
- (33) Press REPEAT key.
- (34) Press MODE/POLARITY key.
- (35) Press F2 key and set POLARITY to "-".
- (36) Gradually rotate VARIABLE clockwise to apply the current to the device.

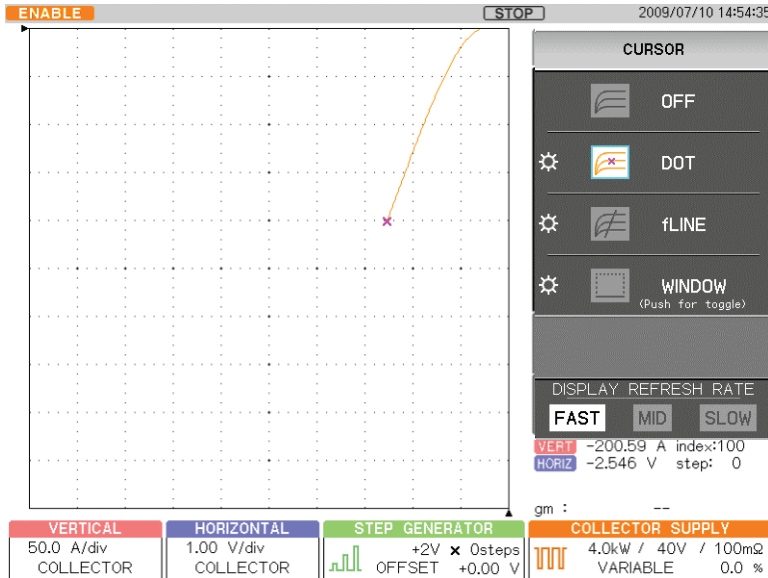

Forward voltage of -2.546 V when applying -200.59 A to the collector of IGBT

Memo

Chapter 5 Daily Maintenance and Calibration

It explains inspection, maintenance, and calibration when using CS-5000.

5.1 Daily maintenance

Caution!

Since electric shock may be generated, be sure to remove the power cord before cleaning.

To clean the exterior, use a soft cloth including a small amount of water and gently wipe it. Use of solvent or detergent prohibited for cleaning may cause discoloration or unexpected failures. Do not use the following solvent and the detergent.
 - Alcohol, gasoline, acetone, lacquer, ether, thinner, detergent including ketone.

Cleaning dust filter (only CS-5200/CS-5300/CS-5400)

HIGH CURRENT part

The filter is mounted in the grill of the front panel. To prevent clogging, clean it regularly.

Caution!

Clogging on the filter reduces the cooling efficiency in the curve tracer, which may cause a failure or reduced life. When the dust filter includes moisture, the temperature or humidity in the curve tracer rises, which may cause a failure. After cleaning the dust filter, dry it completely.

[Procedure]

- (1) Pull the lower part of the grill forward while pushing it up to remove the board grill from the panel.



Grill

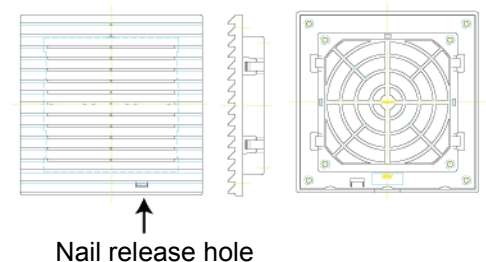

- (2) Remove the filter mounted in the grill and clean it. Use the vacuum cleaner to remove dust and dirt attached to the filter. When becoming severely dirty, wash it with thinned detergent and dry it completely.

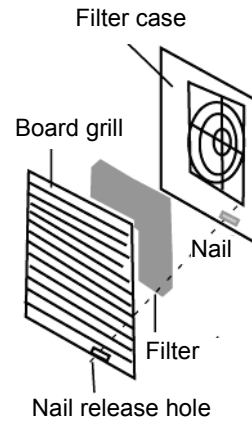

- (3) Mount the filter on the filter case.
When mounting it, insert it inside the nail of grill.

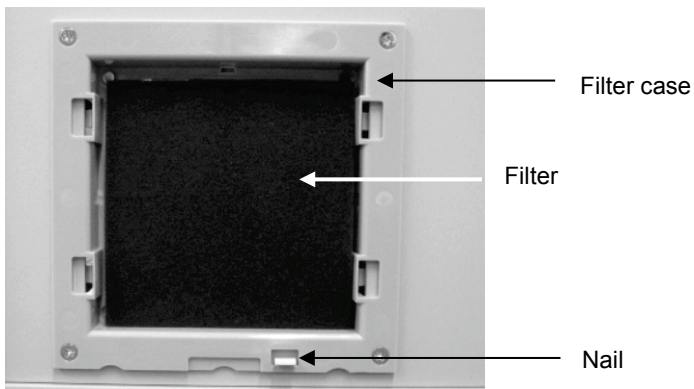

- (4) While locating the upper side of the grill in place and pressing the nail release hole and the center of the grill, push the grill down until it clicks and mount it on the panel.



5.2 Calibration

It is recommended that CS-5000 be calibrated regularly for accurate measurement. For regular calibration of the entire product, contact Iwatsu office or our sales distributors. **Regular calibration once per year** is recommended.

IWATSU ELECTRIC CO., LTD.

Address : 7-41 Kugayama 1-chome Suginami-ku Tokyo, 168-8501 Japan
Phone : +81 3 5370 5483
Facsimile : +81 3 5370 5192
Homepage : <http://www.iti.iwatsu.co.jp>

5.3 Repair and sending of repaired product

If a failure occurs, contact Iwatsu or our sales distributors. If an unexpected failure by our fault occurs during the warranty period, it can be repaired without charge.

When sending the product, please write the product name, production number, failure, name, place, and telephone number of the person in charge clearly.

To avoid an accident during transportation when sending it, use the corrugated carton box used for delivery or equivalent: i.e., having shock absorbing materials. If a proper packing box is not found, contact Iwatsu office or our sales distributors.

IWATSU ELECTRIC CO., LTD.

Address : 7-41 Kugayama 1-chome Suginami-ku Tokyo, 168-8501 Japan
Phone : +81 3 5370 5483
Facsimile : +81 3 5370 5192
Homepage : <http://www.iti.iwatsu.co.jp>

5.4 Storage and transportation

Do not store CS-5000 in the locations below:

- Direct sunlight is received.
- With much dirt
- Corrosive gas is generated.

Conditions to store CS-5000 are as follows:

- Storage temperature: -20°C to +60°C
- Storage humidity: 5% to 80% RH (40°C, without dew condensation)

When transporting CS-5000, use the packing materials attached when purchasing it or equivalent.

Memo

Chapter 6 Specifications

6.1 Product specifications

Hereinafter, HIGH VOLTAGE will be expressed as HV and HIGH CURRENT as HC

(1/4)

Items		Product specifications			
Collector supply (HV mode)	Mode/polarity	AC ± full-wave rectified ±DC ±LEAKAGE			
	Max. peak voltage	30 V, 300 V, 5 kV (AC: 2.5 kV)			
	Max. peak current /pulse peak current	Max. peak voltage	Max. peak current	Pulse peak current	
		30 V	7.5 A	15 A	
		300 V	750 mA	1.5 A	
		5k V	25 mA	25 mA	
	Series resistance	Max. peak voltage			
		Max. peak power	30 V	300 V	5 kV
		390 W	200 mΩ	20Ω	-
	120 W	2Ω	200Ω	-	
	12 W	20Ω	2 kΩ	-	
	1.2 W	200Ω	20 kΩ	-	
	120 mW	2 kΩ	200 kΩ	-	
	32 W	-	-	200 kΩ	
	3.2 W	-	-	2 MΩ	
	320 mW	-	-	20 MΩ	
Max. peak power					
Max. peak voltage: 30V,300V	120 mW, 1.2 W, 12 W, 120 W, 390 W				
Max. peak voltage: 5kV	320 mW, 3.2 W, 32 W				
Variable collector supply	Continuously variable from 0% to 100.0% (in 0.1% step) Note: Output not calibrated				
Output enabled/disabled	Collector supply can be set to output enabled/disabled.				
Loop calibration	Hardware	Floating capacity between collector supply and ground can be calibrated.			
	Software	Software thinning pseudo-calibrates the loop.			
Collector supply (HC mode) *Specifications for CS-5200/5300/5400	Mode/polarity	±PULSE			
	Max. peak voltage	40 V (CS-5200/5300), 30 V (CS-5400)			
	Max. peak current	CS-5200/5300		CS-5400	
		10 kW	1 kA (CS-5300)	12 kW	1.5 kA
		4 kW	400 A	4.5 kW	600 A
		400 W	40 A	450 W	60 A
	Output enabled/disabled	HC mode allows output from the collector supply to be ENABLE or DISABLE.			
	Pulse width	50 us to 400 us (in 10 us step) Note) If the pulse width is narrow, up to max. peak voltage may not be generated.			
	Pulse interval	CS-5200/5300		CS-5400	
80 ms to 1000 ms (at 400 W)		100 ms to 1000 ms (at 450 W)			
160 ms to 1000 ms (at 4 kW)		200 ms to 1000 ms (at 4.5 k W)			
320 ms to 1000 ms (at 10 kW)		400 ms to 1000 ms (at 12 kW)			
Pulse measurement point	10 us to Pulse width setting value (in 10 us step)				
No. of data pieces	20 to 1000 points/trace				

Items		Product specifications
Step generator	Output accuracy	2 % of all output + 5 % × STEP AMPLITUDE setting + within (1 mV or 1 nA)
	Offset	
	Setting range	–10 times to +10 times of STEP AMPLITUDE setting
	Resolution	STEP AMPLITUDE setting ×1%
	Current mode	
	Amplitude range	50 nA to 200 mA per step, 21 steps, 1-2-5 switching
	Max. current	±2 A
	Max. voltage	10 V or more
	Voltage mode	
Amplitude range	50 mV to 2 V per step, 6 steps, 1-2-5 switching	
Max. voltage	±40 V	
Max. current	At least 500 mA at 8 V or less, at least 200 mA at 15 V, at least 10 mA at 40 V	
Step 1/10	1/10 times of step current / voltage setting value	
Step rate	50 Hz or 60 Hz × 2 (× 1 when collector supply mode is set to AC) Pulse interval setting when collector supply is set to HC mode.	
Pulse step		
Pulse width	50 us to 400 us (in 10us step) When collector supply is in HC mode, pulse width is wider than that of the HC mode pulse; i.e., additional 100 us at each end Note) If the pulse width is narrow, to max. peak voltage may not be generated.	
No. of steps	0 step to 20 steps	
AUX output	Range	Off, –40 V to +40 V, 100 mV step
	Accuracy	100 mV + 2% of setting value
Measurement	Mode	REPEAT, STOP / SINGLE, SWEEP
Vertical axis	Collector current	
	Range	HV:1 uA/div to 2 A/div , 20steps , 1-2-5 switching (for all) HC:100 mA/div to 200 A/div, 11 steps, 1-2-5 switching(CS-5400) HC:100 mA/div to 100 A/div, 10 steps, 1-2-5 switching(CS-5300) HC:100 mA/div to 50 A/div, 9 steps, 1-2-5 switching(CS-5200)
	Accuracy	2% of readout + 0.05 × VERT/div setting value or less Note 1: Internal loop calibration error below is added to the expression above. 5kV range: 12uA, 300V range: 1uA, 30V range: 0.5 uA Note 2: Only areas of 30% or more in 5kV range and 10% or more in 300V/30V range are specified.
	Emitter current	
	Range	1nA/div to 2mA/div , 20 steps, 1-2-5 switching (Collector supply mode: ±LEAKAGE)
	Accuracy	2% of readout + 0.05 × VERT/div setting value + 1 nA or less
	Step generator display	
Range	0.5 step/div	
POSITION	Inside of tube: 10 div	
Magnification display	×2, ×5, ×10	

Items		Product specifications
Horizontal axis	Collector voltage	
	Range	HV:50 mV/div to 500 V/div, 13 steps, 1-2-5 switching HC:50 mV/div to 5 V/div , 7 steps, 1-2-5 switching
	Accuracy	2% of readout + 0.05 × HORIZ/div setting value or less
	Base/emitter voltage	
	Range	50 mV/div to 5V/div, 7 steps, 1-2-5 switching
	Accuracy	2% of readout + 0.05 × HORIZ/div setting value or less
	Step generator display	
	Range	0.5 step/div
	POSITION	Inside of tube: 10 div
	Magnification display	×2, ×5, ×10
Display	Type	8.4-inch TFT-LCD
	Resolution	SVGA: 800 × 600 pixel
	No. of data pieces	1000 points / trace (AC full-wave rectified) 20 to 1000 points / trace (SWEEP mode)
	Trace display	Interpolation display between points, dot display
	Average	Off, 2 to 255 times
	Persistence	Off, Short, Long, infinite
	Internal waveform storage (REF)	4 screens can be saved.
Cursor measurement	DOT cursor	Vert, Horiz, β, or gm
	fLINE cursor	Vert, Horiz, 1/grad, intercept
	FREE cursor	Vert, Horiz, β, or gm
	WINDOW cursor	Vert, Horiz, β, or gm in WINDOW area
Built-in timer	Display	Year/month/day/hour/minute
Internal memory	Setup memory	256 memories
External memory	USB memory	USB1.1 Setup, waveform save/recall, screen hard copy (BMP, TIFF, PING)
Interface		10 Base-T/100 Base-TX Ethernet
Power supply	Power input range	AC 100-240 V, 50/60 Hz
	Power consumption(Operating)	500 VA (400 W) Max
	Power consumption(Standby)	50 VA (7 W) Max

Items		Product specifications
Body	Outside dimensions (W × H × D)	424 mm × 220 mm × 555 mm (CS-5100) 424 mm × 354 mm × 555 mm (CS-5200/5300/5400) (Excluding attachment and projection)
	Mass	About 28 kg (CS-5100, excluding attachment and options) About 43 kg (CS-5200/5300/5400, excluding attachment and options)
Environment conditions	Performance ensured temperature range	+10°C to + 35°C
	Operation ensured temperature range	0°C to +40°C
	Operation ensured humidity range	0 to +40°C 5% to 80% RH (at 30°C or less) and no dew condensation allowed Upper limit value: 55% RH (at 40°C) and no dew condensation allowed
	Warming up time	30 minutes or more after powering on Note) The specifications standards are guarantee values after 30 minutes or more from turning on the power supply pass.
	Storage temperature range Storage humidity range	-20°C to +60°C, 5% to 80% RH (without dew condensation)
	Altitude (air pressure)	At operation: 2000 m or less (air pressure: about 79 kPa) At non-operation: 15000 m or less (air pressure: about 12 kPa)
	Pollution degree	2
	Power supply environment	IEC60364-4-443: For protection Against Overvoltage's of Atmospheric Origin or Due to Switching Power supply transient maximum voltage does not exceed IEC60364-4-443 CAT II. Temporary Overvoltages Short-term: 1440 V Long-term: 490 V
Accessories	Test fixture :1 - CS-303 : CS-5100/5200/5300 - CS-304 : CS-5400 Test adapter CS-500 (Blank adapter) :1 Wire set :1 set (7 wires) Instruction manual (Printed matter) :1 CD (Instruction manual / Remote control manual) :1 Power cord :1 Cord strap :1	

6.2 Compliance standards

Items		Specifications
Compliance	CE marking	<p>This instrument meets the requirements of EMC Directive 2014/30/EU for Electromagnetic Compatibility, Low Voltage Directive 2014/35/EU for Product Safety and RoHS Directive 2011/65/EU for restriction of the use of certain hazardous substances.</p> <p>Emission and Immunity standard EN61326-1: 2013 ClassA</p> <p>Safety standard EN61010-1: 2010 3rd Edition EN61010-2-30: 2010 1st Edition</p> <p>Environmental standard EN50581:2012 Monitoring and instruments</p>

6.3 Outside view

6.3.1 Main unit (CS-5100)

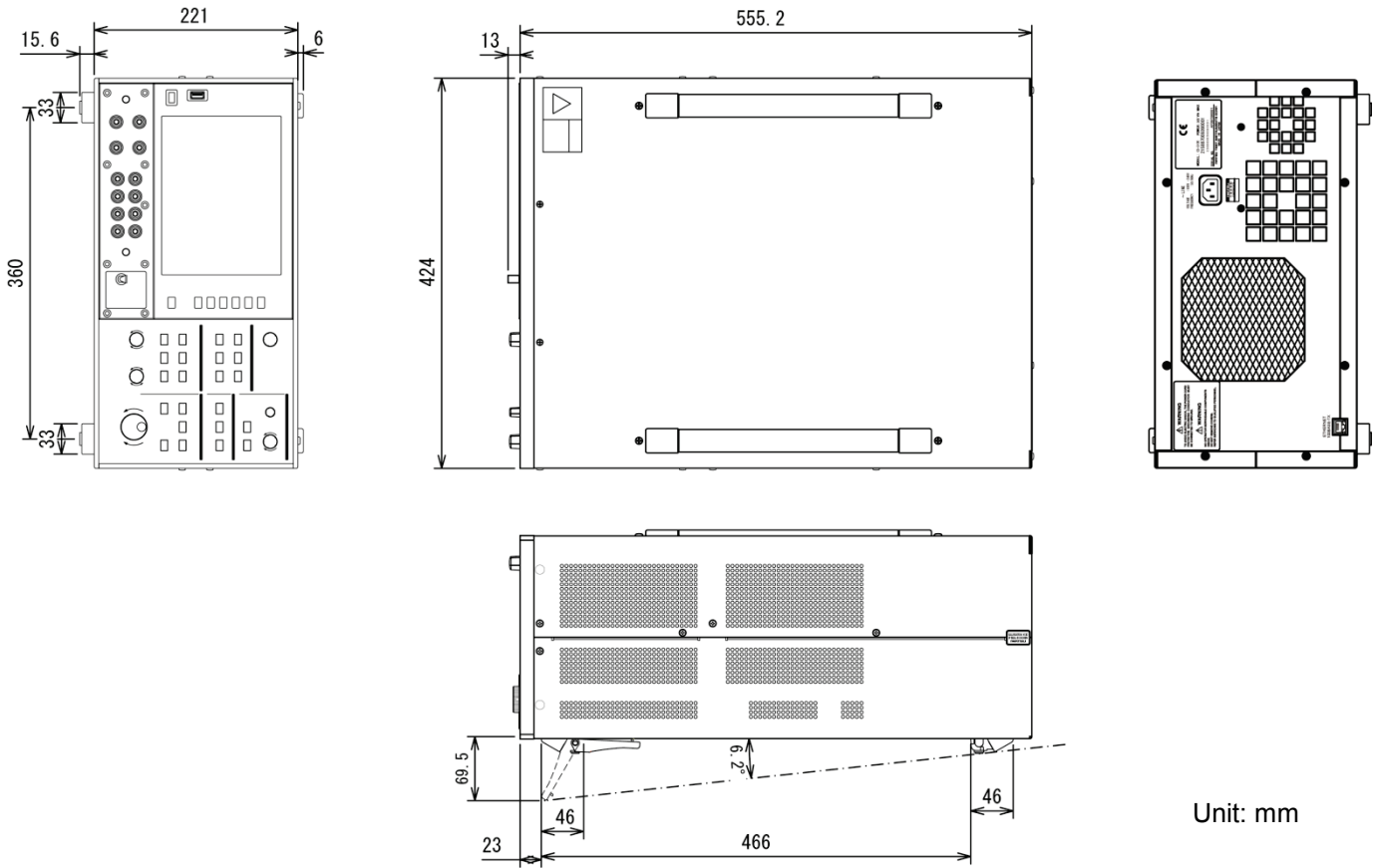

6.3.2 Main unit (CS-5200/CS-5300/CS-5400)

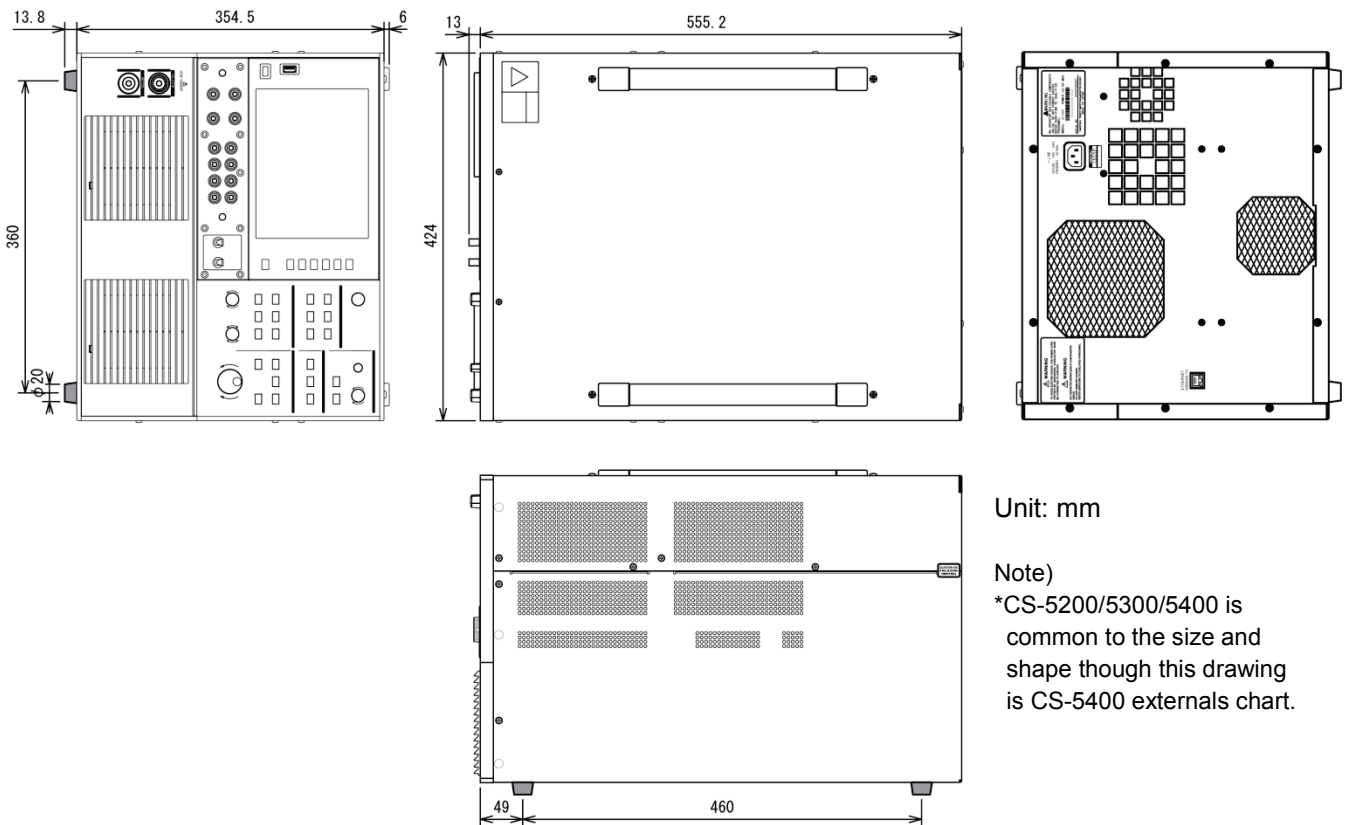

6.3.3 Test fixture CS-303 (For CS-5100/CS-5200/CS-5300)

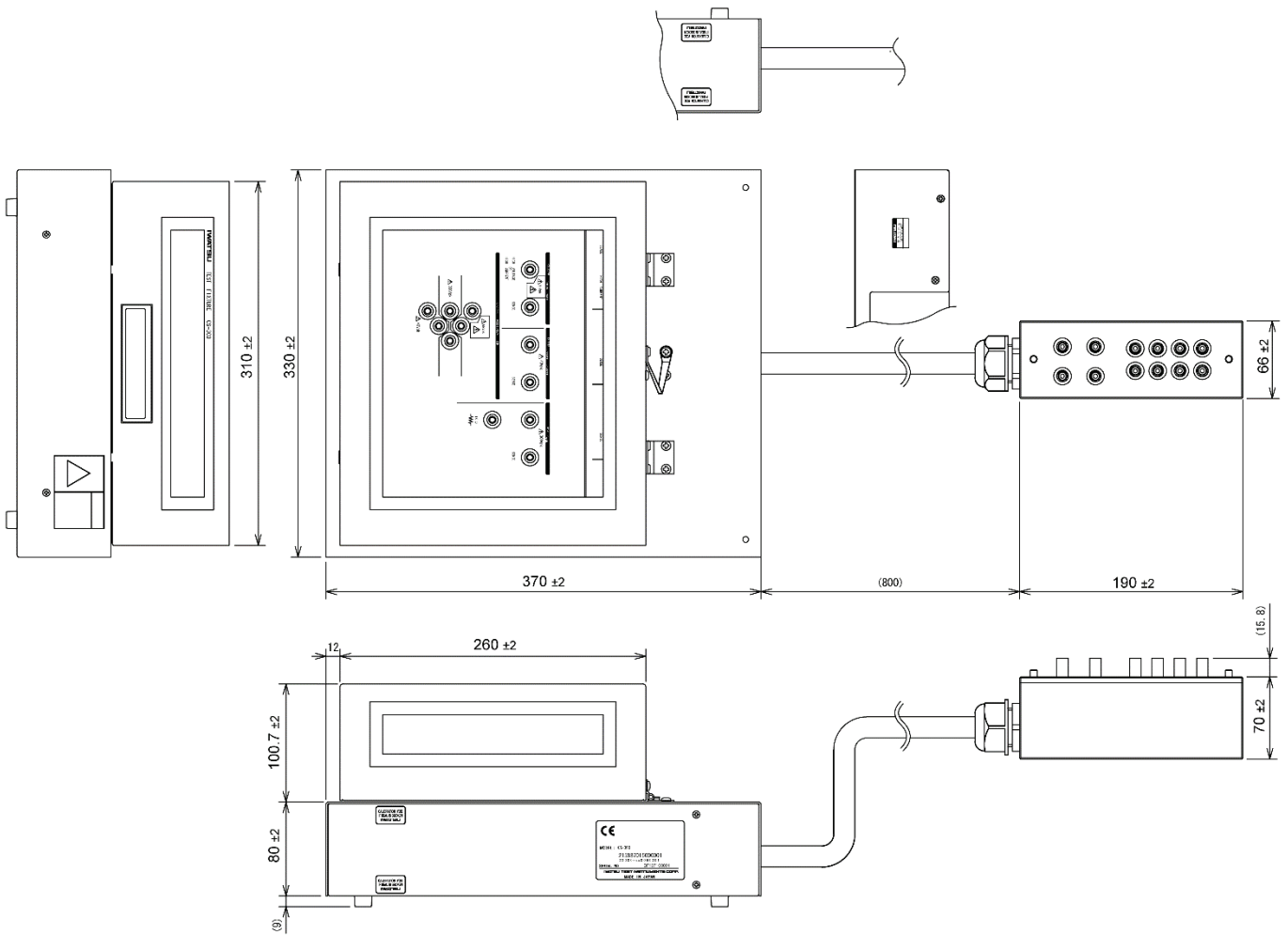

Unit: mm

6.3.4 Test adapter CS-500 (Blank adapter)

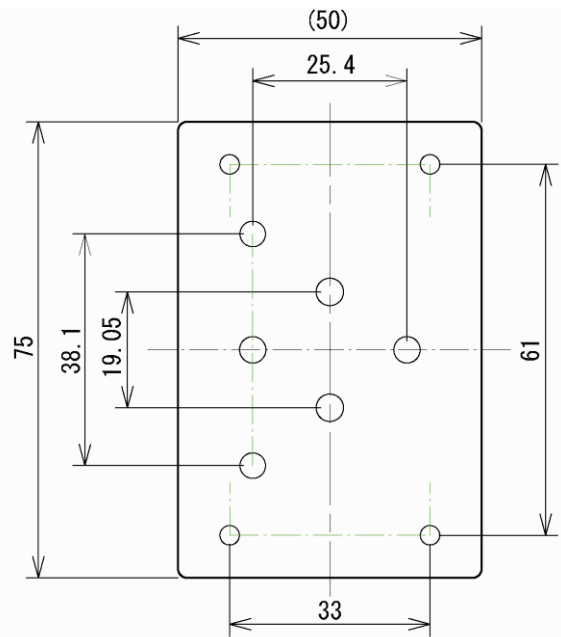
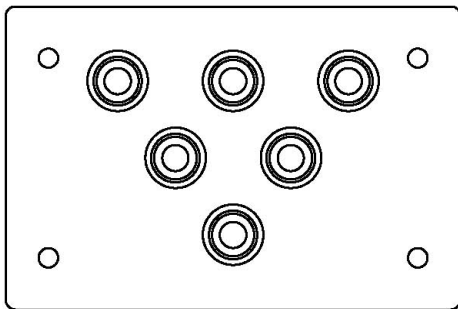
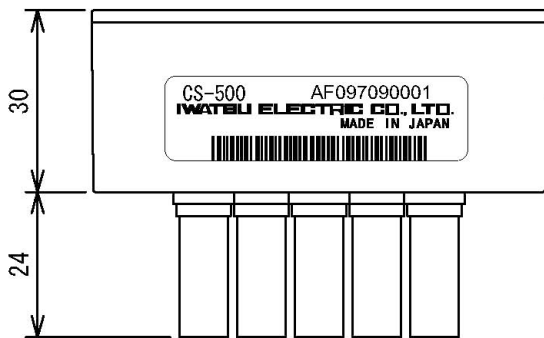
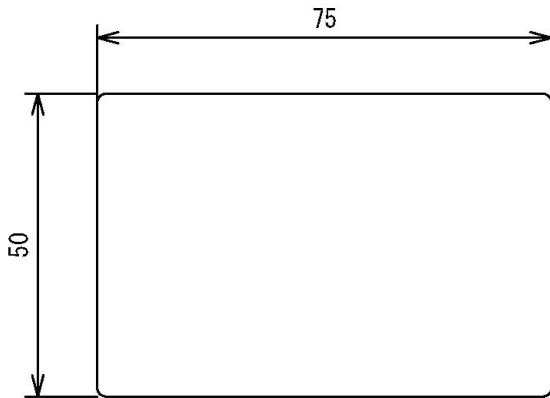

Unit: mm

6.3.5 Test fixture CS-304 (For CS-5400)

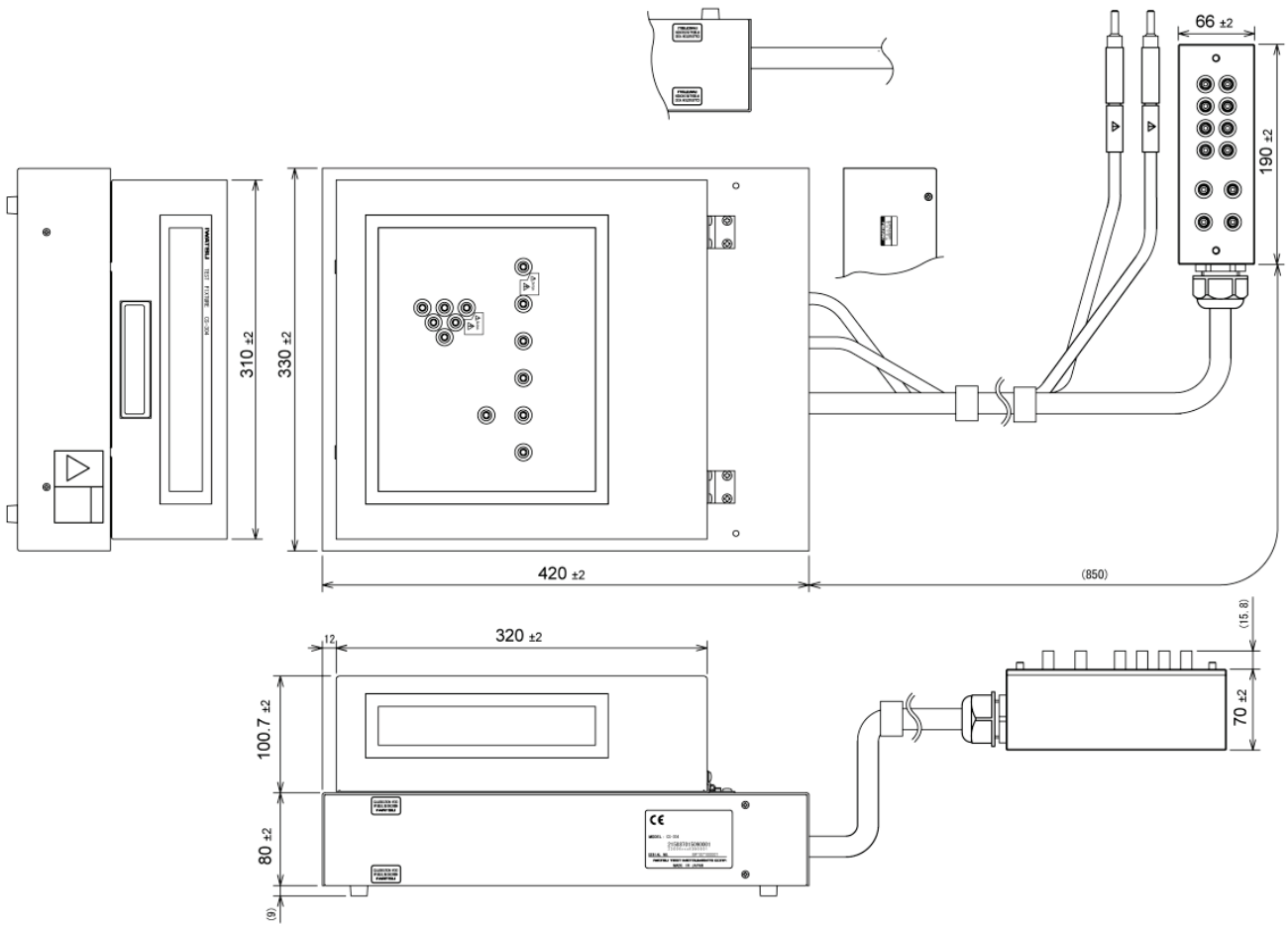

Unit: mm

6.3.6 Test adapter CS-501A (TO type adapter, option)

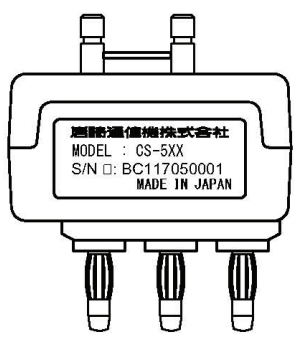
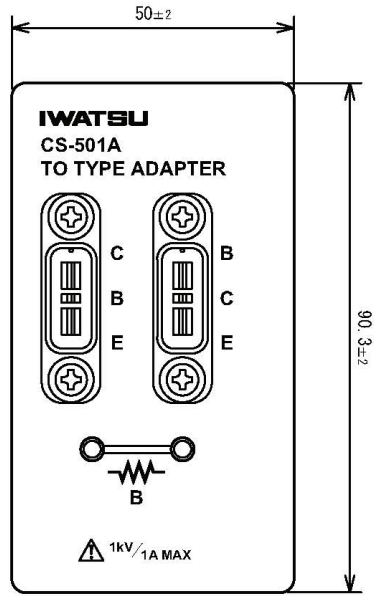
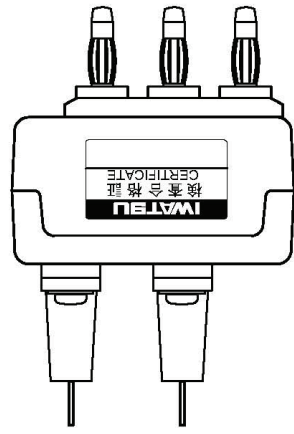
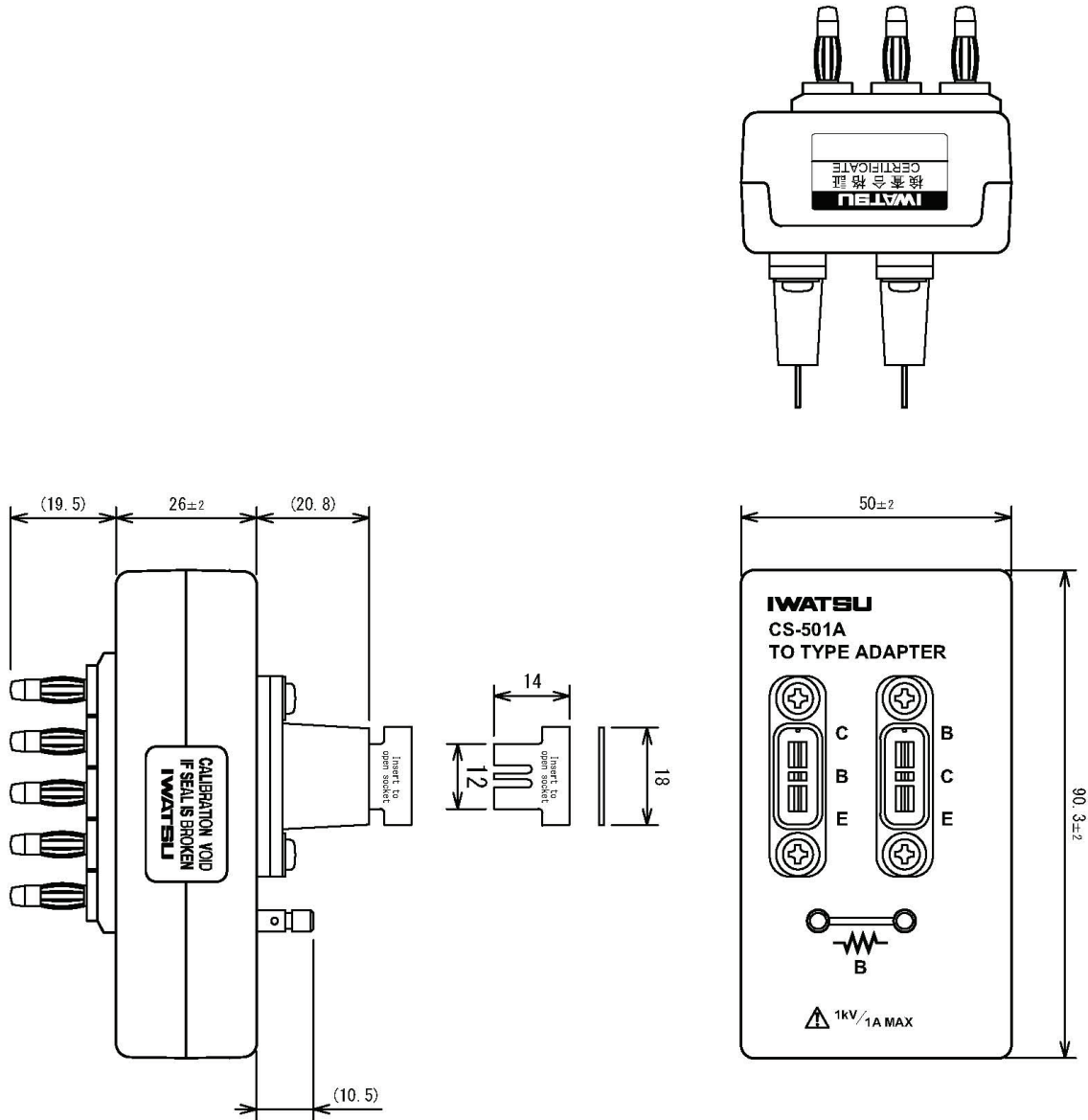

Unit: mm

6.3.7 Test adapter CS-502 (Axial type adapter, option)

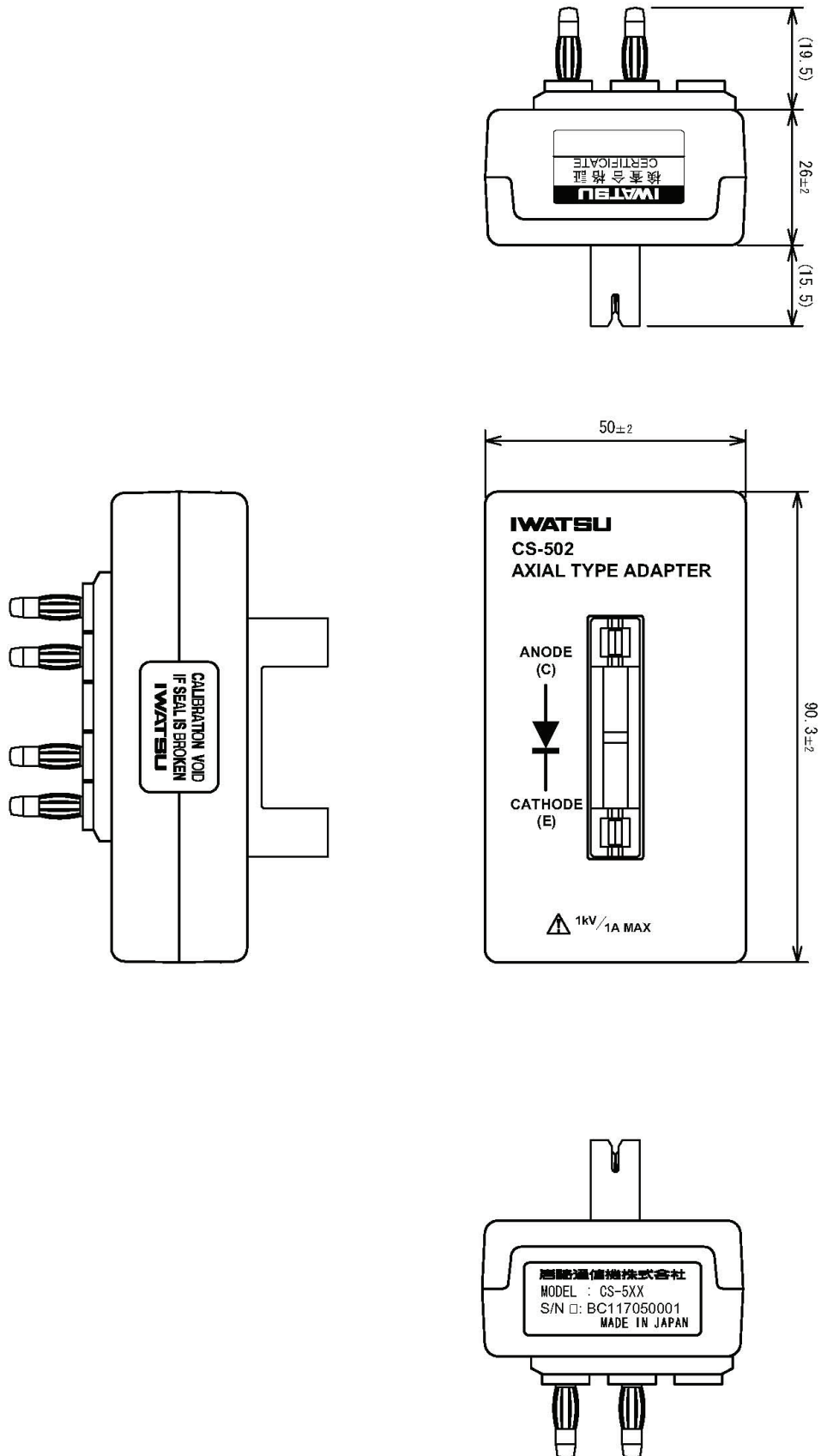

Unit: mm

6.3.8 Test adapter CS-503 (Surface Mount type adapter, option)

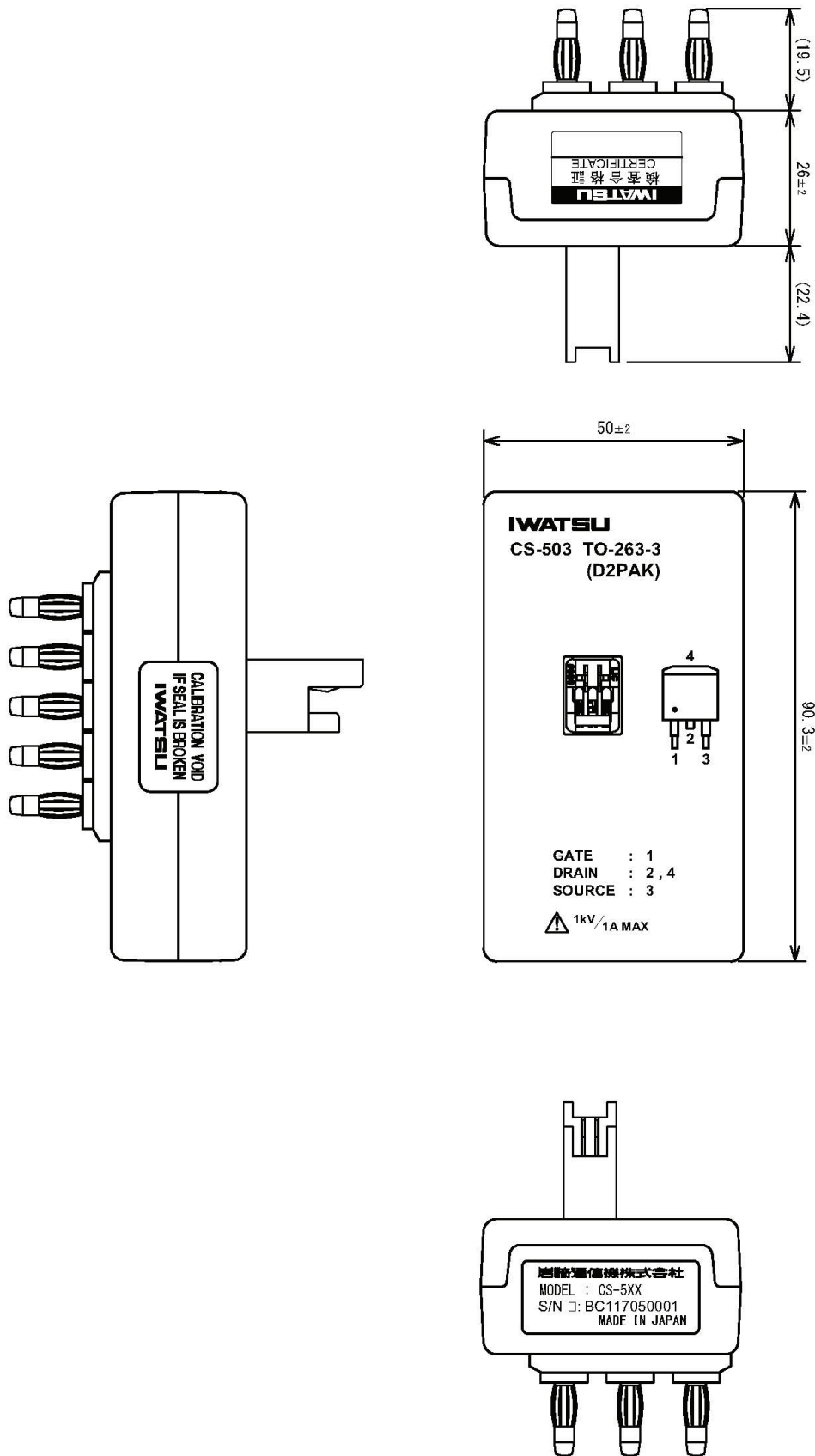

Unit: mm

6.3.9 Test adapter CS-504 (Surface Mount type adapter, option)

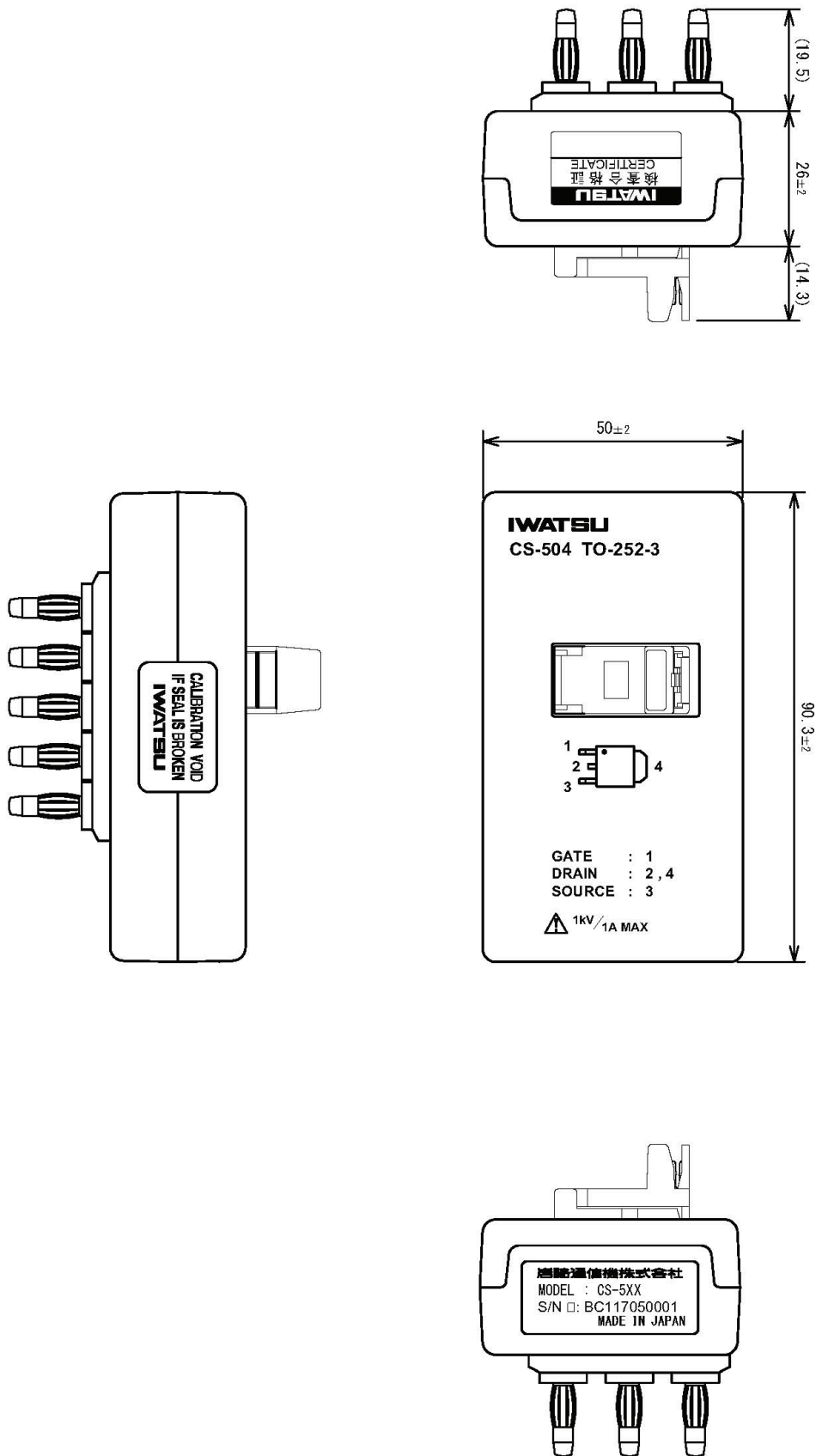

Unit: mm

6.3.10 Test adapter CS-505 (Surface Mount type adapter, option)

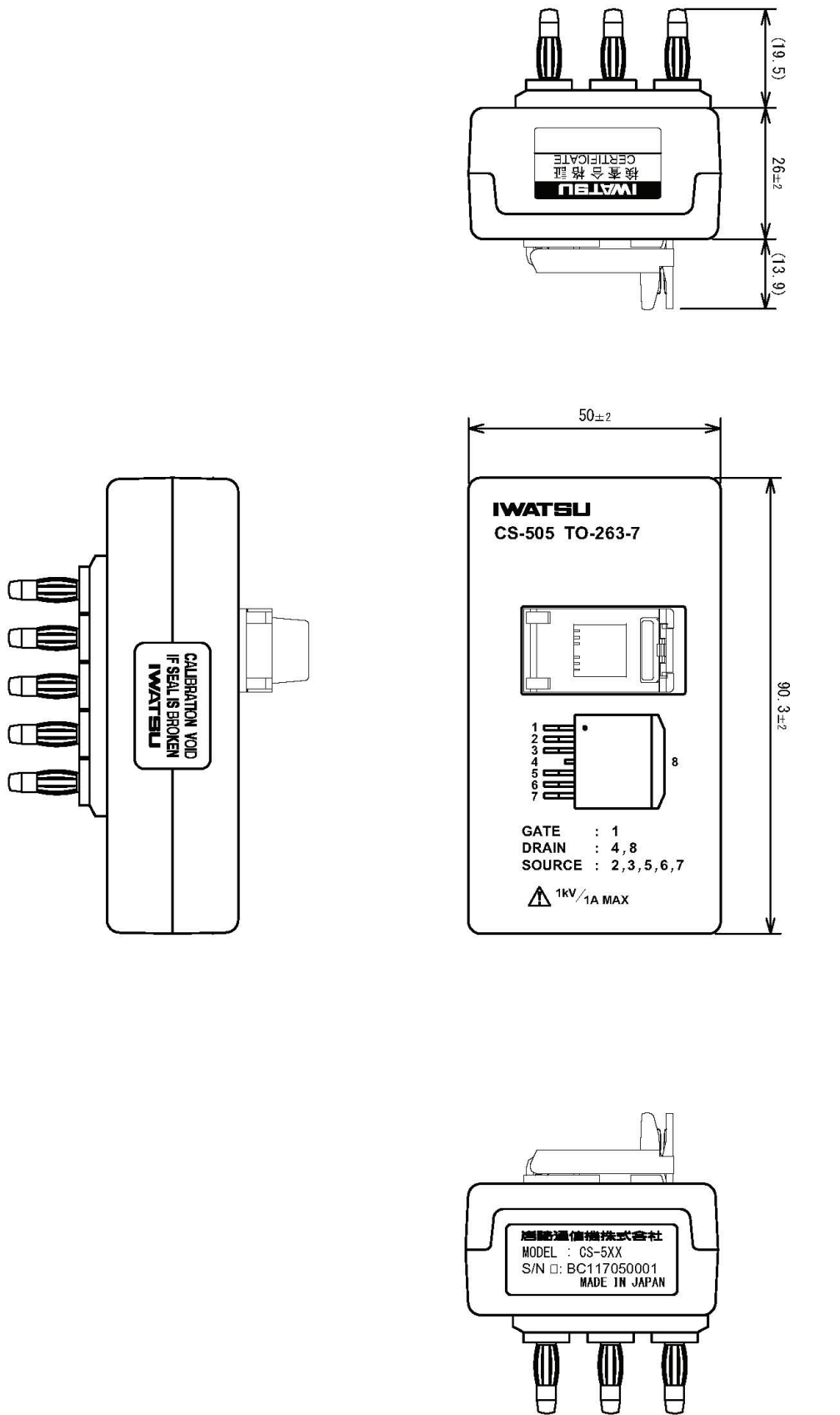

Unit: mm

6.3.11 Test adapter CS-506 (Surface Mount type adapter, option)

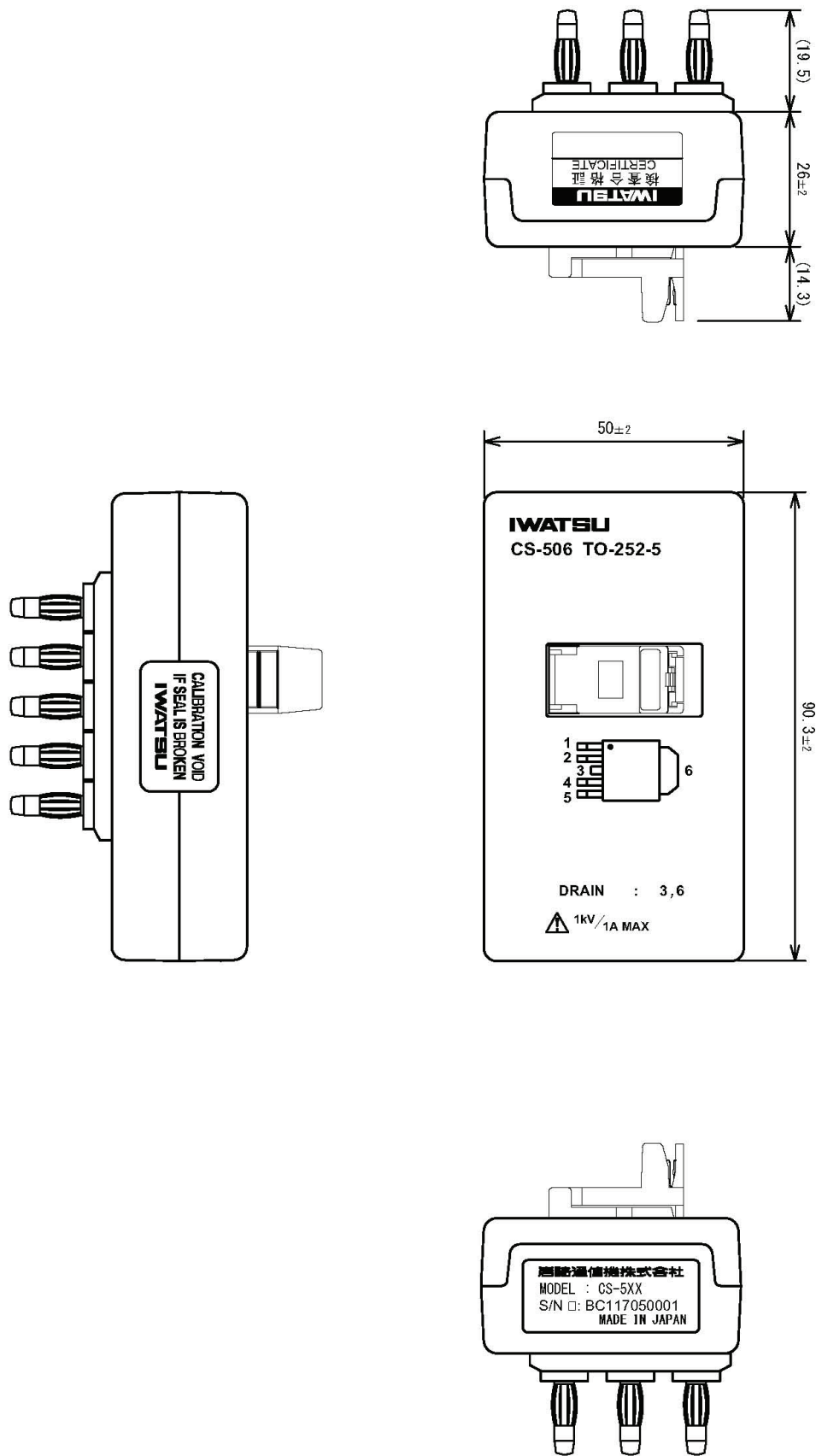

Unit: mm

6.3.12 Test adapter CS-507 (Surface Mount type adapter, option)

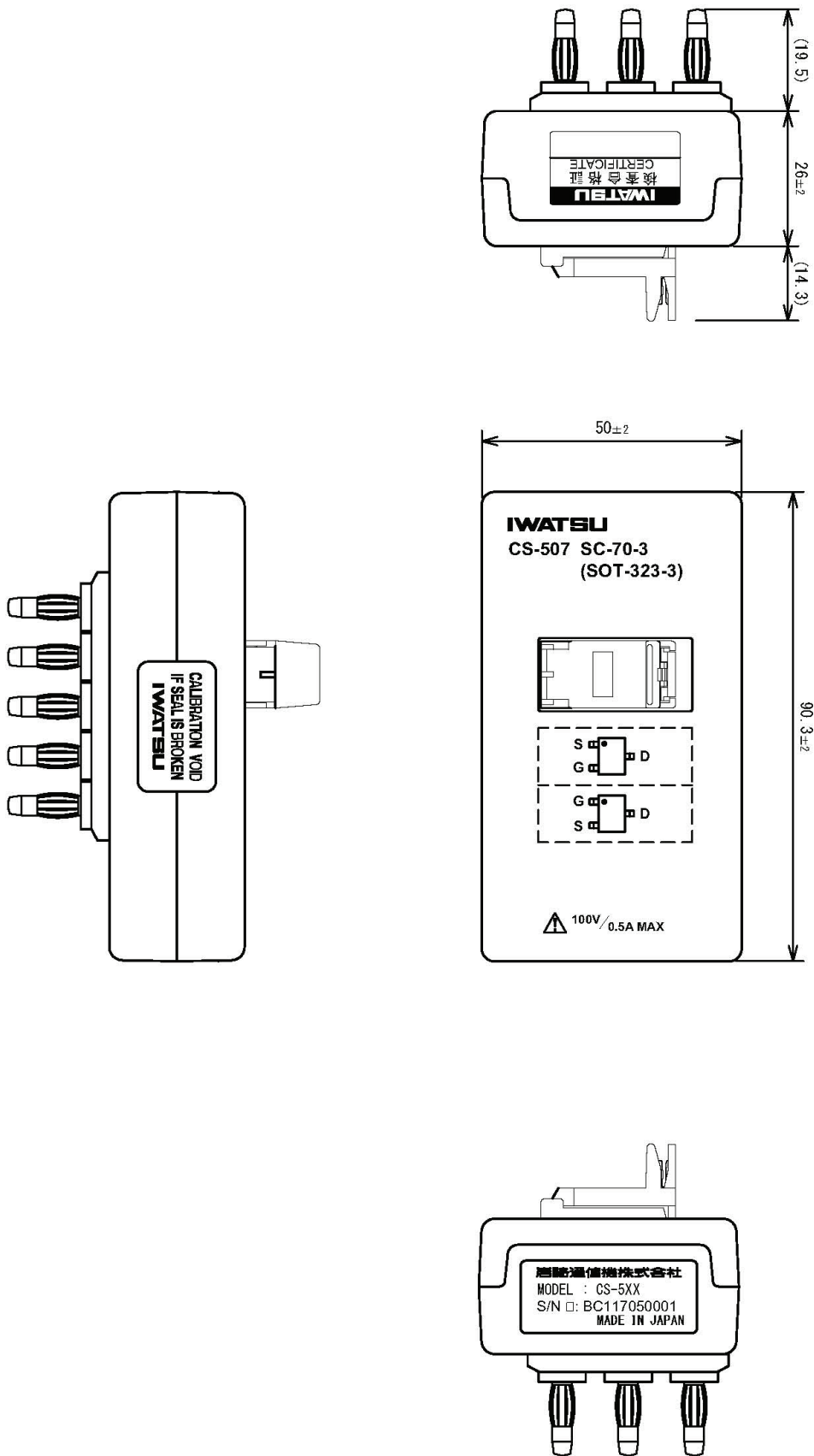

Unit: mm

6.3.13 Test adapter CS-508 (SMD CHIP type adapter, option)

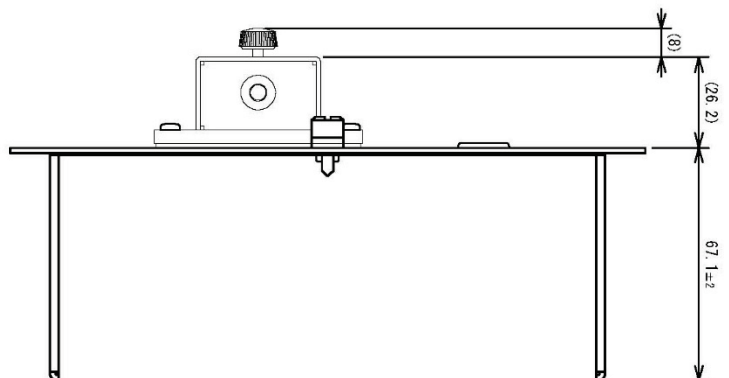
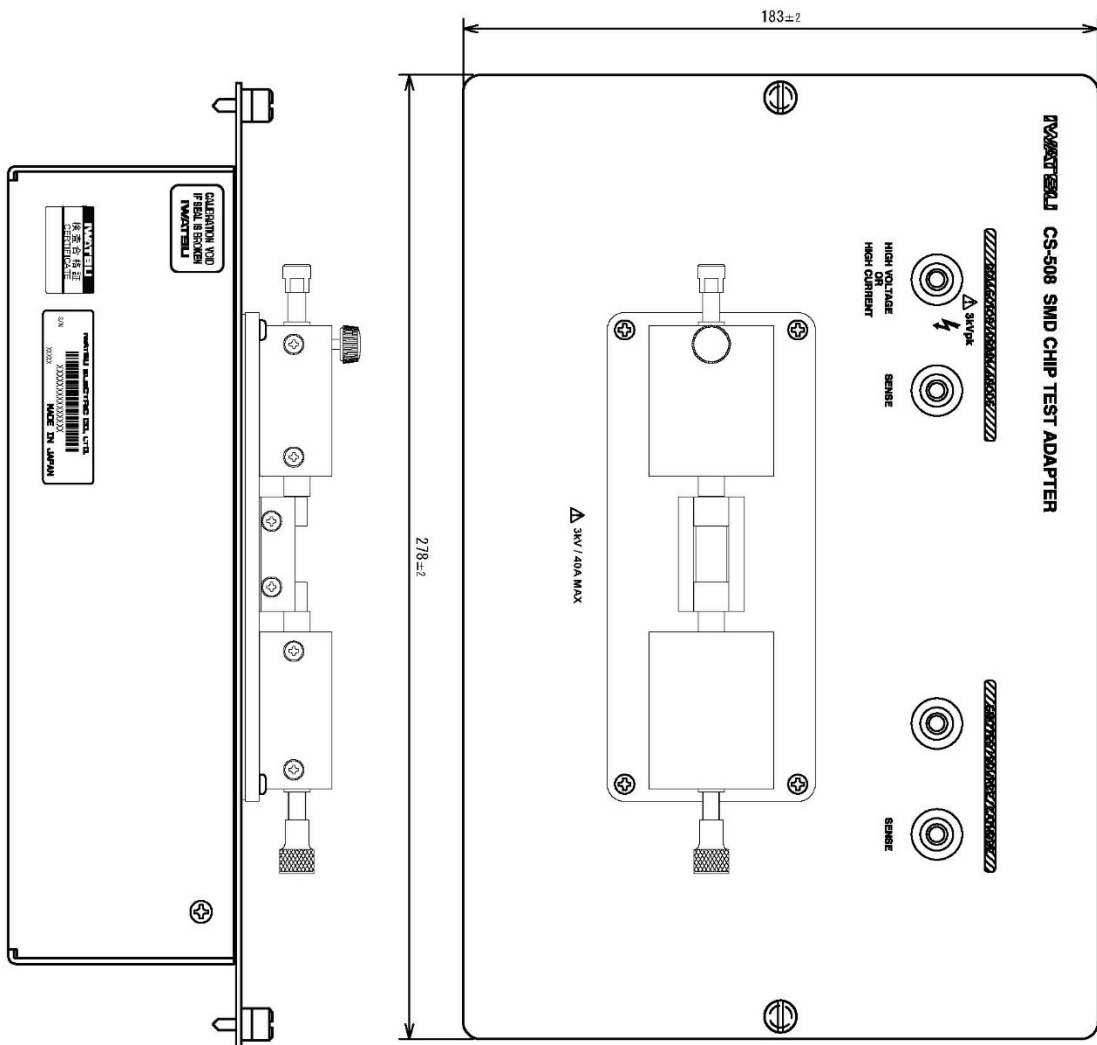

Unit: mm

6.3.14 Test adapter CS-509 (Surface Mount type adapter, option)

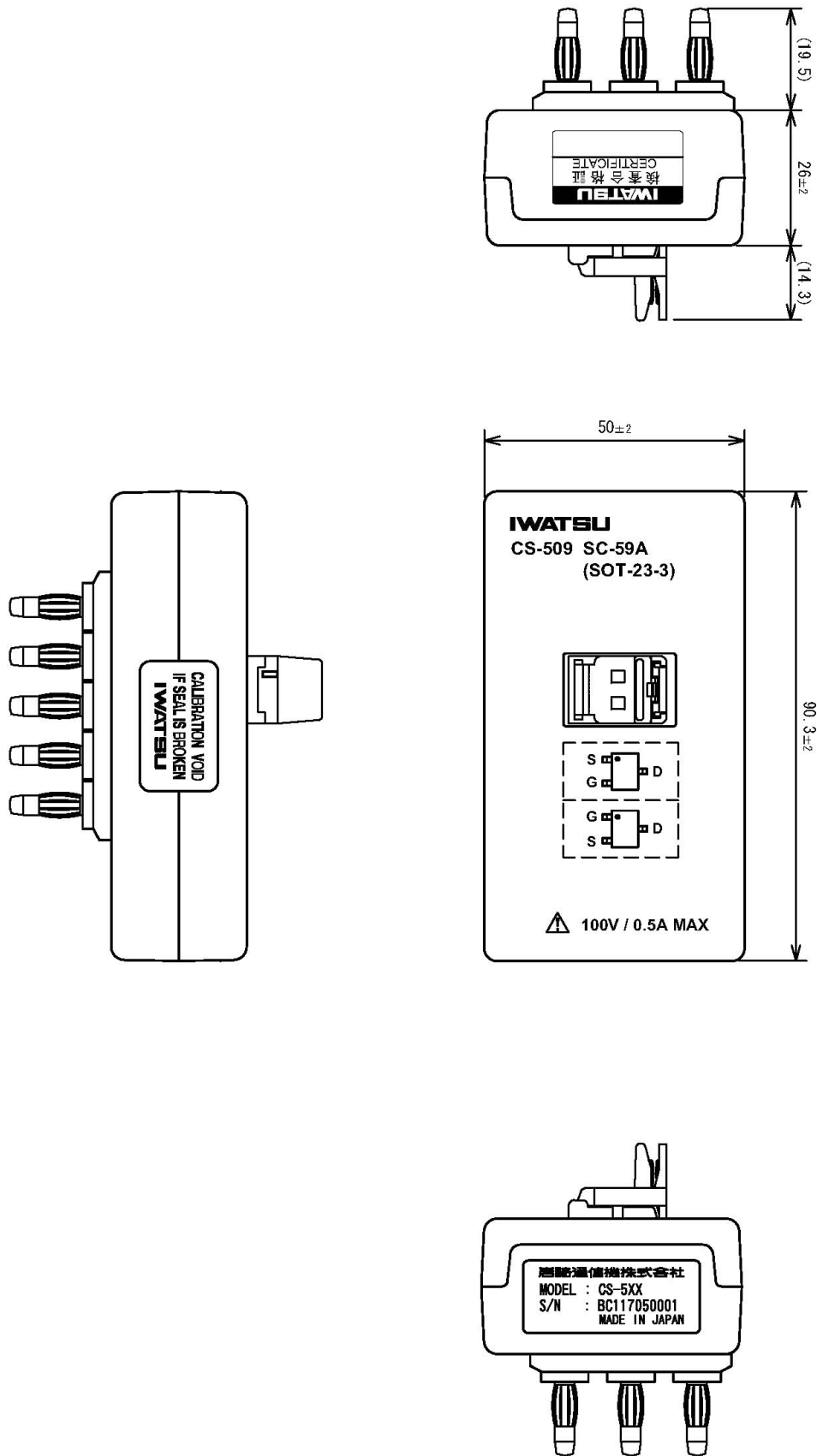

Unit: mm

6.3.15 Test adapter CS-510 (Surface Mount type adapter, option)

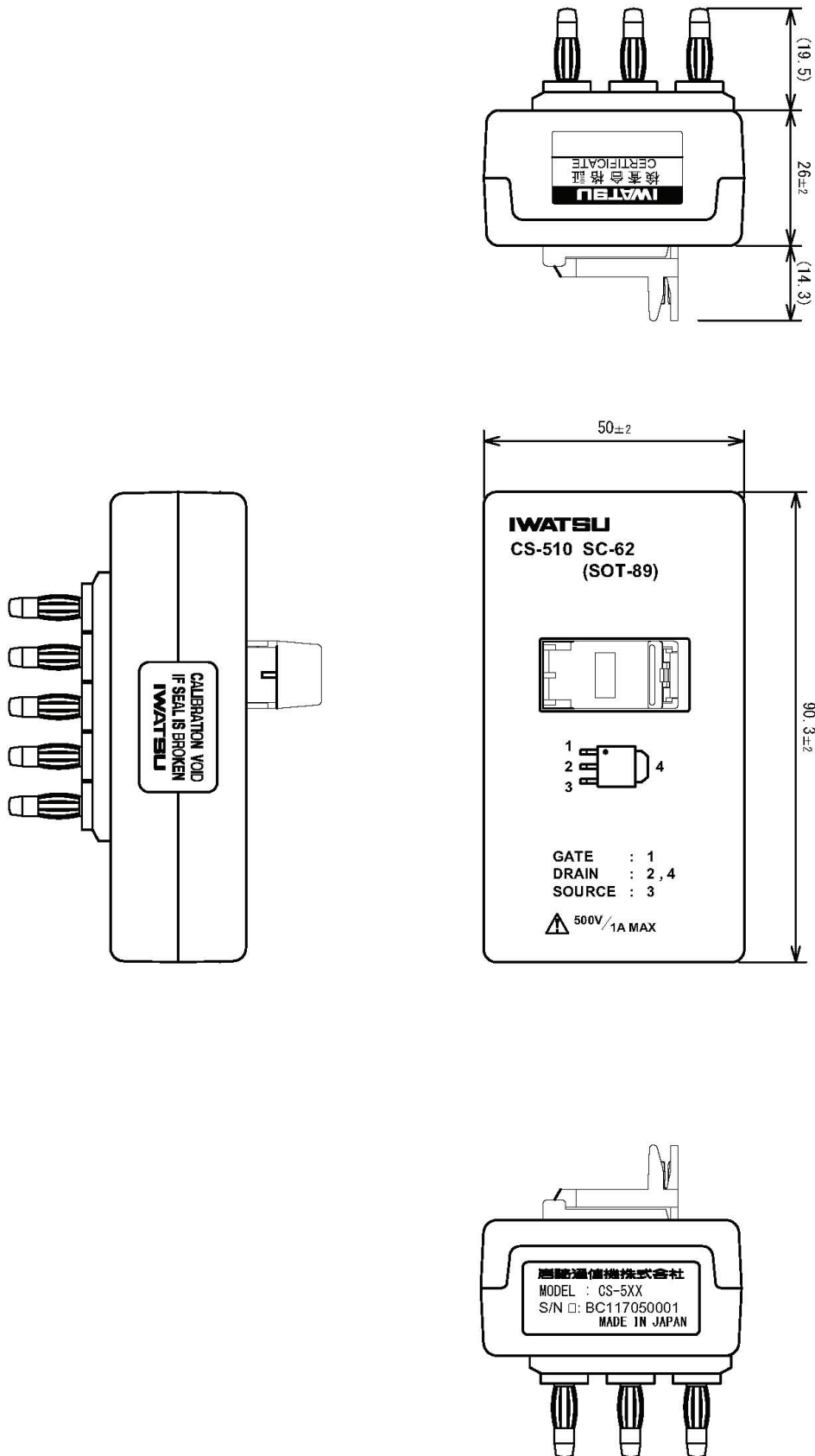

Unit: mm

IWATSU ELECTRIC CO., LTD.

Address : 7-41 Kugayama 1-chome Suginami-ku Tokyo, 168-8501 Japan

Phone : +81 3 5370 5483

Facsimile : +81 3 5370 5492

Homepage : <http://www.iti.iwatsu.co.jp>